

Ethernet DC/DC Converter EPC1055H & EPC1055P

- Features**
- 70 % Typical efficiency at full load
 - Input / Output Isolation
 - Designed for low common mode noise
 - Input filter to reduce input ripple current
 - Regulated
- (Less than 10 mA p-p typical)

Electrical Specifications

*Note : Package with G = Surface Mount Device, †† : E1,E1-G,E4,E4-G,E11,Q,Q1, N4-G

PCA P/N	STD PKG	Optional Packages	Input Voltage V	Output Voltage V	Output Current mA Max.	Output Ripple & Noise @ 20 MHz BW mV p-p	Isolation Vrms
EPC1055P	E	E-G*, F2,N1,††	5 ± 10%	15 ± 5%	135 Max.	100 Max.	500
EPC1055H	E1	E1-G*,F2,N1,Q1	5 ± 10%	15 ± 5%	135 Max.	100 Max.	2000

Pin Connections for E**

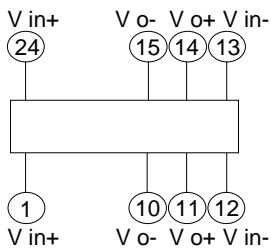

Pin Connections for E1

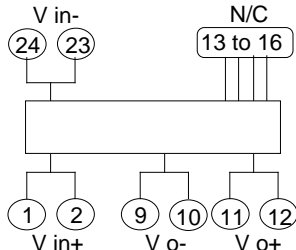

Pin Connections for N1

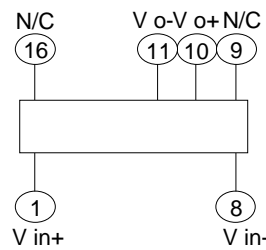

Pin Connections for F2

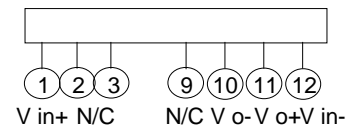

Package E

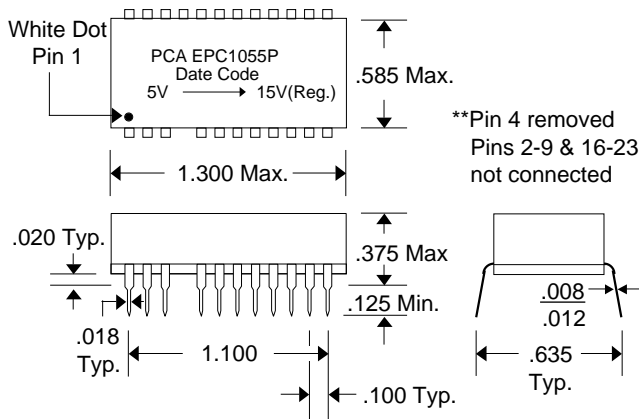

Package F2

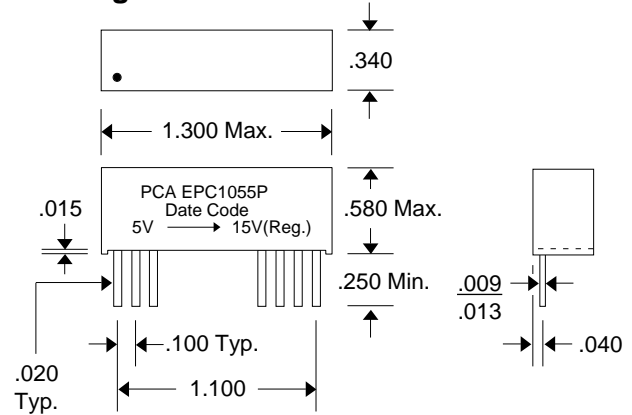

Package E1

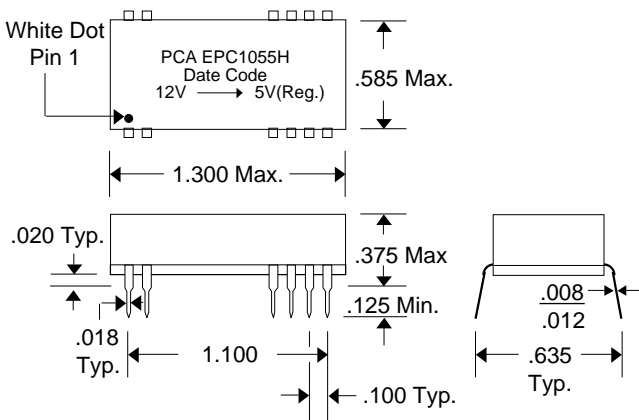

Package N1

