

Dual USB / Gigabit Filter Port Jacks

EPJ4018



- Space saving RJ-45/USB Connectors •
- Thermo Plastic PBT UL94V-0 Rated Connector Housing •
- Metal Shield : Nickel Plated Copper Alloy •
- Pins : 0.018 Tin-Coated Copper Wire •

Electrical Parameters @ 25° C

OCL (μ H Min.)	Insertion Loss (dB Max.)	Return Loss (dB Min.)		CMRR (dB Min.)	CMD (dB Min.)	Turns Ratio (\pm 5%)	Crosstalk (dB Min.)
@ 100 KHz, 100m Vrms	1-100 MHz	1-30 MHz	@ 60 MHz @80 MHz	100 KHz- 100 MHz	100 KHz- 100 MHz		1-100 MHz
8 mA DC Bias							Xmit - Rcv
350	-1	-20	-18 -12	-30	-30	1CT:1CT	-30

• LEDs : Vf=2.1V Typ. @ 20 mA • Isolation : 1500 Vrms • Operating Temperature : 0°C to +70°C •

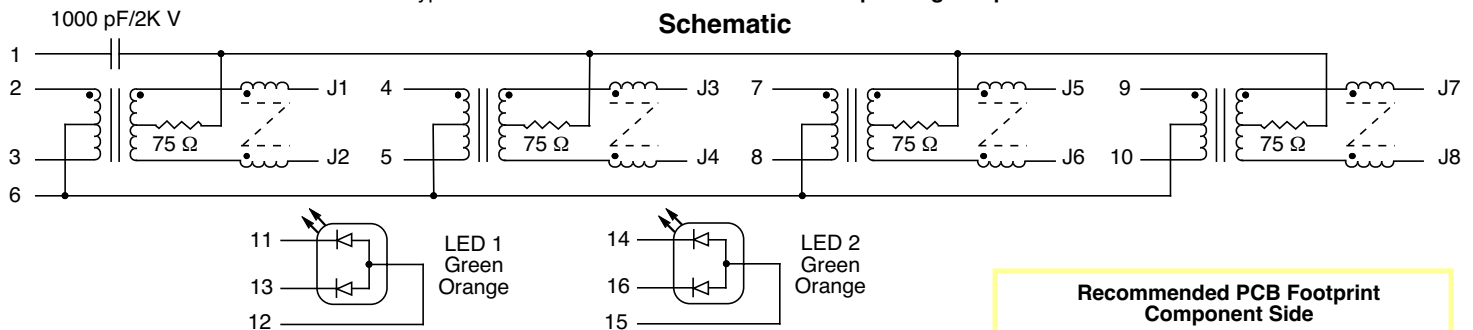

Recommended PCB Footprint Component Side

Package

Pin Assignment

