

M12 Miniature Photoelectric Switches DM



- Diffused, polarised retro-reflective and through-beam
- Nickel-plated housing with IP67 protection
- Multifunction LED status indicator
- Pre-cabled or M12 plug connector
- NO/NC selectable
- Local and remote teach-in function



Options and ordering codes

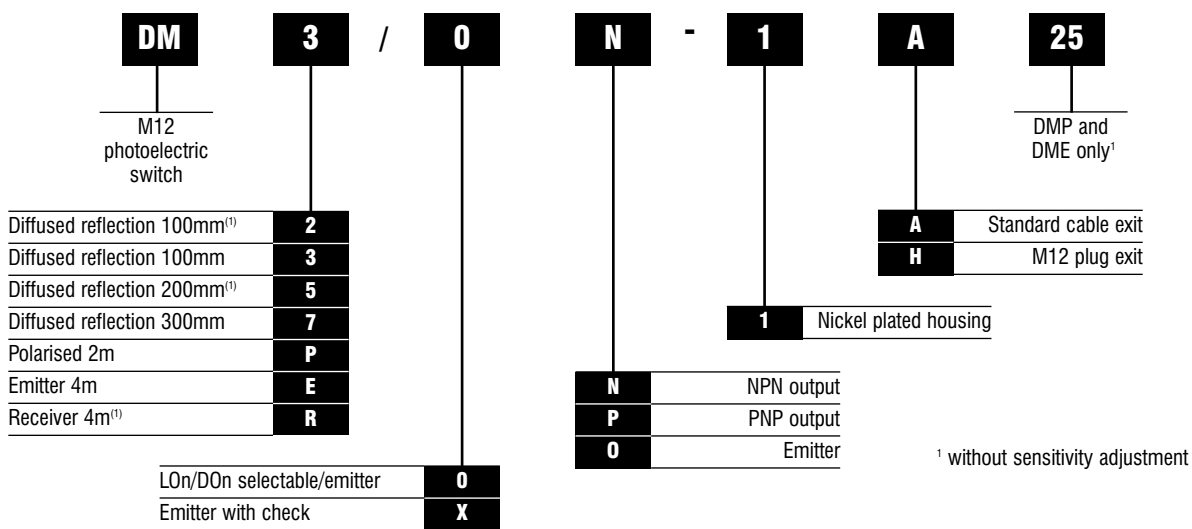

Specification

Model	DM2/0*-1*	DM3/0*-1*	DM5/0*-1*	DM7/0*-1*	DMP/0*-1*	DMR/0*-1*	DME/*0-1*
	Diffuse reflection				Polarised	Through-beam	
Nominal sensing distance	100mm ^a		200mm ^a	300mm ^b	2m ^c	4m	
Emission	Infrared (880nm)				Red (660nm)	Infrared (880nm)	
Tolerance	+15%/-5%						
Differential travel	10% maximum					20% maximum	
Repeat accuracy	5%						
Operating voltage	10-30VDC						
Ripple	10% maximum						
Load current	100mA						
No-load current	20mA						
Leakage current	10µA maximum (VDC maximum)						
Output voltage drop	2V maximum I _L =100mA						
Output type	NPN/PNP – Light On/Dark On selectable						
Switching frequency	400Hz					250Hz	
Time delay before availability	150ms						
Supply electrical protection	Polarity reversal and transient						
Output electrical protection	Short circuit (auto-reset)						
Operating temperature	-25 to +70 °C						
Interference by sunlight	10000 lux						
Protection degree	IEC IP67						
Sensitivity adjustment	N/A	Teach-in	N/A		Teach-in	N/A	Trimmer
Tightening torque	10 Nm						

^a Test target 100x100mm white paper ^b Test target 200x200mm white paper ^c Reflector RL110

M12 Miniature Photoelectric Switches

DM continued



Wiring diagrams

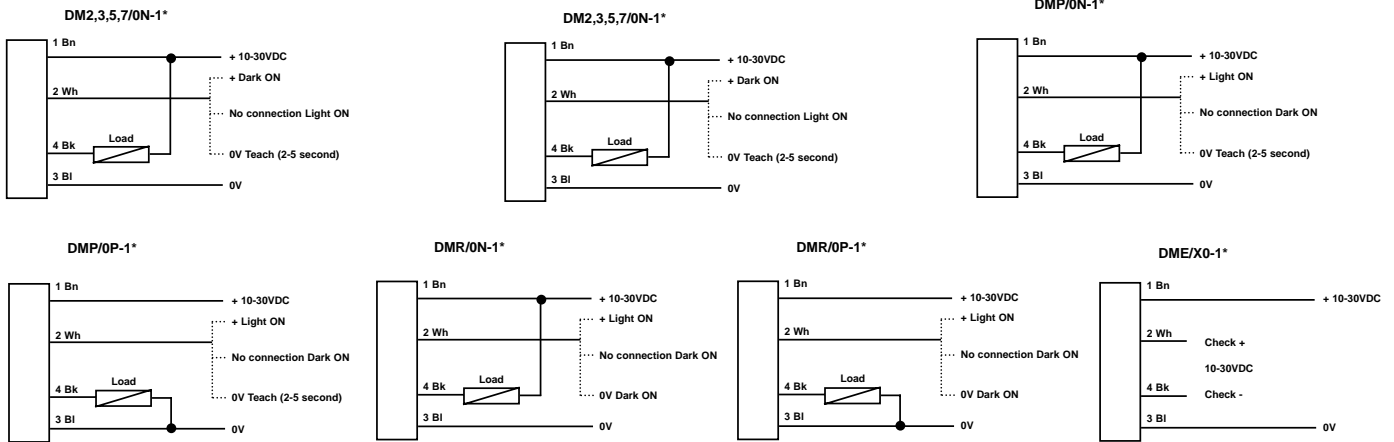

Dimensions (mm)

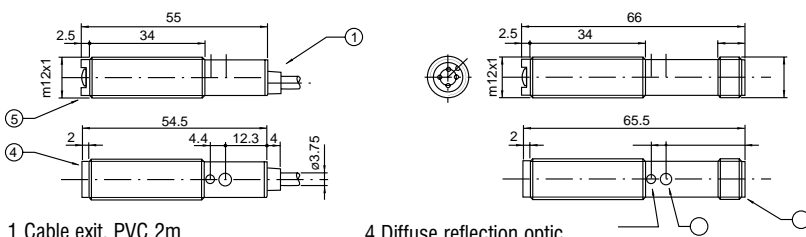

- 1 Cable exit, PVC 2m
- 2 M12 meta plug connector
- 3 Teach-in Button

- 4 Diffuse reflection optic
- 5 Retro-reflective

Connector connections (M12)

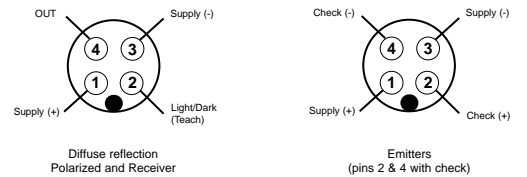

Accessories

Antidust front ø12mm ST36

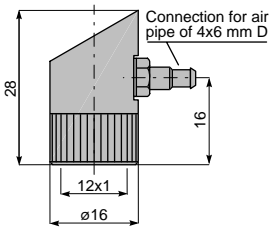

material: anodised aluminium

This is used to prevent dust or other deposits on the lenses of photoelectric switches ø12mm*, thus ensuring constant detection is maintained. It consists of a threaded body with a side air inlet pipe.

The sensitivity loss is approx. 20-30%.



*not suitable for diffuse models.

Protection front ø12mm ST60

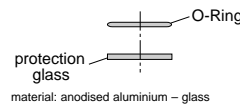
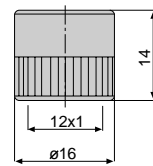

material: anodised aluminium - glass

For the protection of the lenses of photoelectric switches ø12mm*. It allows use of the sensor even in particularly aggressive conditions (presence of chemical solvents etc.)

The system consists of a threaded metal body, an O-ring and a protection glass.

The sensitivity loss is approx. 20-25%.

*not suitable for diffuse models.

Shutter ø12mm STOM_

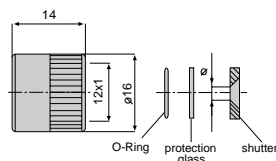

material: anodised aluminium - glass

This accessory, available for through-beam photoelectric switches ø12mm, reduces the emitted beam allowing the detection of small targets (down to 1mm). The shutter consists of a threaded ring nut, a protection glass, an O-ring and an aperture to be screwed on the optical head of both transmitter and receiver.

The attained sensing ranges refer to the minimum detectable target as indicated in the table below

Right angle beam adaptor ø12mm ST37

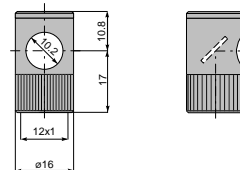

material: anodised aluminium

For directing the photoelectric detection through 90° to the photoelectric switch optical axes for ø12mm* sensors.

This accessory consists of an internal threaded body to be screwed on the optical head of the photoelectric switch.

The mirror inside the body is set at 45° to the optical axes of the sensor allowing detection at 90°.

The sensitivity loss is approx. 20-30%.

*not suitable for diffuse models.

Shutter code	STOM1	STOM2	STOM3	STOM4	STOM5	STOM6
MM series	1	2	3	4	5	6
Ø minimum target (mm)	1	2	3	4	5	6
sensing range (m)	0.05	0.20	0.40	0.60	1.40	2.00

M12 Miniature Photoelectric Switches

DM continued



Characteristic curves

DM2,3/** **

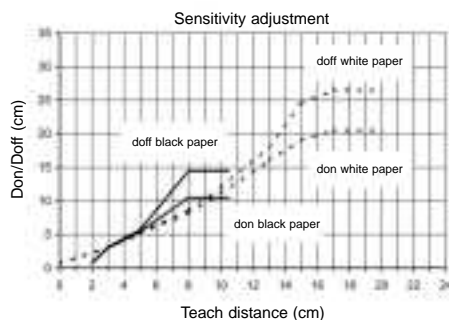
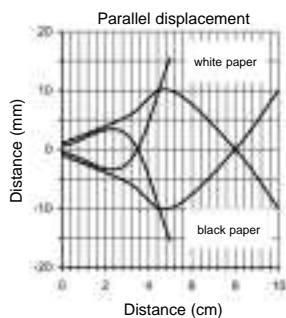
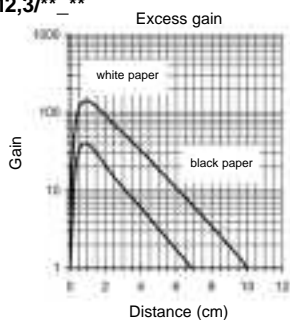

DM5/** **

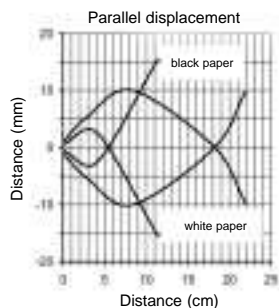
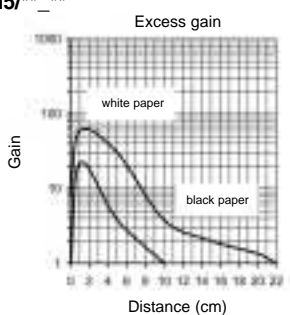

DM7/** **

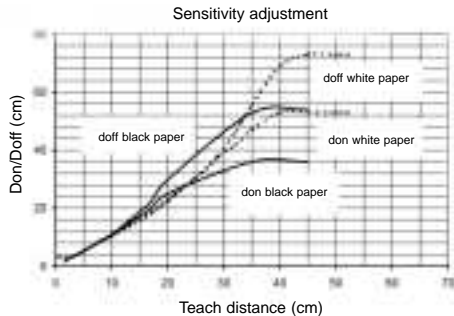
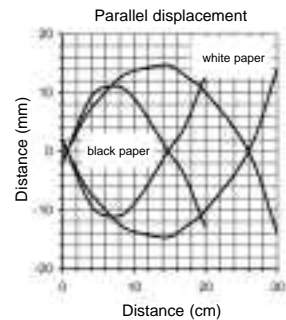
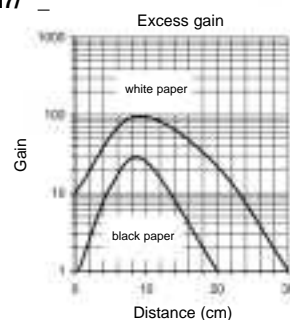

DM7/** **

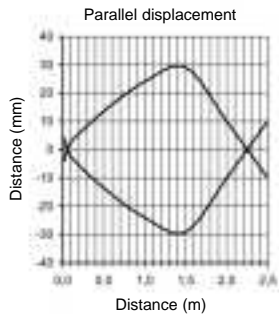
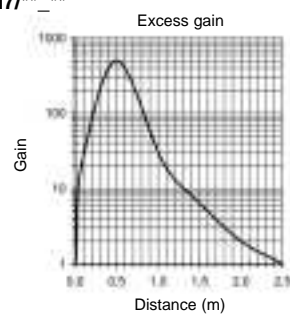

DME/** ** DMR/** **

