BlueTiger™ Connected Optical Drive Family
CD-80 CD Player
Data Sheet version 1.30
March 2009

StreamUnlimited Optical Storage GmbH
Gutheil-Schoder-Gasse 10
1103 Vienna
Austria

Phone: +43 1 60101 4998
Fax: +43 1 60101 4401

Copyright © 2008

StreamUnlimited Optical Storage



StreamUnlimited
Optical Storage

All rights reserved. Reproduction in whole or in part is prohibited without the prior consent of the copyright owner. The information presented in this document does not form part of any quotation or contract, is believed to be accurate and reliable and may be changed without notice. No liability will be accepted by the publisher for any consequence of its use. BlueTiger is a registered trademark of StreamUnlimited Optical Storage. All other trademarks included herein are the property of their respective owners.

Abstract

Describes the CD-80 Commercial and Technical Specification.

Document History

No.	Primary Author(s)	Description of Version	Date Completed
v.1.0	CAP	Initial revision	02-04-2008
v.1.1	MJI	Added OPU connectors	04-04-2008
v.1.2	CAP	corrected polarity of mute line, added chapter 5.5 on output signal validity	20-04-2008
v.1.3	MJI	Add info for top loading	06-03-2009

Related Documentation

Part Number	Description
BT-CD-80-PB	BlueTiger CD-80 Product Brief
BT-CD-80-SW-CMD-IF	BlueTiger CD-80 Software Command Interface
JPL-2580	JPL-2580 tray loading mechanism specification
JPSL-33	JPSL-33 slot loading mechanism specification
I²C specification	THE I ² C-BUS SPECIFICATION, VERSION 2.1, JANUARY 2000

Ordering Information

Part Number	Description	remark
BT-CD-80/10	CD-80 board standard version	single supply
BT-CD-80/30	CD-80 board CD-OPU version	HW provision only

Release Notice

This document is under configuration control and updates will only be issued as a replacement document with a new version number.

Confidentiality Notice

The information contained in this document is confidential information property of StreamUnlimited Optical Storage GmbH. No part of this document may be used or reproduced without written permission.

Copyright Notice

All rights reserved. No part of this work covered by the owners copyright may be reproduced or copied in any form or by any means (graphic, electronic or mechanical, including photocopying, recording, taping or information retrieval systems) without the written permission.

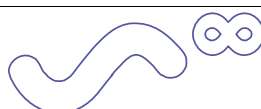

Preface

Warnings and Restrictions

It is important to operate CD-80 within the specified input and output ranges described in this document. Exceeding the specified input/output ranges may cause unexpected operation and/or irreversible damage to your development system. If there are questions concerning the input/output ranges, please contact a company representative prior to connecting the input power. Applying loads outside of the specified output range may result in unintended operation and/or possible permanent damage to your development system.

If You Need Assistance

If you have questions regarding either the use of this software command interface or the information contained in the accompanying documentation, please contact StreamUnlimited Optical Storage.

Copyright

© 2008 StreamUnlimited Optical Storage GmbH. All right reserved

Contents of this publication may be not reproduced in any form without the written permission. Reproduction and / or reverse engineering of copyrighted software is prohibited.

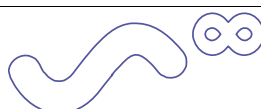
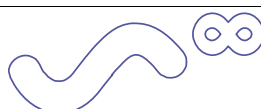

Table of Contents

Preface	3
Table of Contents	4
Introduction	5
1 Board Overview	6
2 Block Diagram/System Architecture	7
3 Physical specification	8
3.1 <i>Dimensions</i>	8
3.2 <i>Layout</i>	9
3.3 <i>Stuffing versions</i>	10
3.4 <i>Interfaces</i>	11
3.4.1 <i>Signal specifications</i>	11
3.4.2 <i>Connector types and wiring requirements</i>	12
3.4.3 <i>External Interface connector</i>	12
3.4.4 <i>Slot Loader Connector (for JPSL-33)</i>	13
3.4.5 <i>Tray Loader Connector (for JPSL-2580)</i>	13
3.4.6 <i>Traverse Connector</i>	13
3.4.7 <i>CD OPU Connector</i>	14
3.4.8 <i>DVD OPU Connector</i>	15
4 Playability	16
4.1 <i>Media</i>	16
4.2 <i>Test discs</i>	16
5 Application information	17
5.1 <i>Power cycle timing</i>	17
5.2 <i>Absolute maximum ratings</i>	17
5.3 <i>Power requirements</i>	18
5.4 <i>Safety</i>	18
5.5 <i>Muting concept, output data validity</i>	18
5.6 <i>Operating temperature range</i>	19
6 EMC/ESD	20
6.1 <i>EMC</i>	20
6.2 <i>ESD</i>	20



Introduction

This document specifies the Commercial and Technical Specification of the CD-80 board. It is a board for use in the high end audiophile CD segment.

CD-80 contains the complete CD servo and decoder frontend (NXP SAA7824) with power amplifier (AMTEK AM5810) and an onboard microcontroller (ARM7 based). Only D/A conversion, power supply and a simple front-board is required to build a high end CD player.

The board matches to following loaders and traverse mechanisms:

- StreamUnlimited JPL-2580 loader mechanism with SONY KHM313 or DM33 (SANYO SF-HD850 based mechanism)
- WXD8829C loader with SONY KHM313 or DM31 (SF-HD850 based mechanism)
- JPSL-33 slot-loading mechanism with SONY KHM313

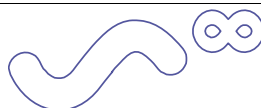

1 Board Overview

The Hardware and firmware is compatible to all loaders and traverse mechanism listed above. The configuration is done via the high level Software interface by the frontboard firmware (AC_Set_Loader command). This command has to be sent after startup to configure the firmware (see BT-CD-80-SW-CMD-IF for details).

Communication

CD-80 requires a host microcontroller to send high level commands and read back UI information. The formatting of the data read to fit the specific display used in the set has to be done in the host controller. For a list of command please refer to the CD-80 Board command interface specification. All high level commands for a basic implementation of a high end CD player are available as well as a set of commands that allow a different implementation of a certain feature or even a new one. For example CD-80 does not have a command for a programmable A->B repeat, but such a function can easily be implemented in the host micro by reading the current time on disc at the position A and B and sending the command Goto_Min_Sec_Frame on the disc to play and repeat the part between those positions.

The communication utilizes standard I²C protocol, CD-80 is slave. It uses an IRQ line to signal availability of data to the host microcontroller to reduce CPU load of the host.

Supported Loaders/OPU

CD-80 can support 9 combinations of Loader and Traverse/OPU. The selection is done by the host muC as the first command after startup. If the host muC has integrated or access to flash memory, it is recommended to make the selection (especially of OPU) selectable by either unique button combinations or RC commands to the front panel, so that the set can be set to either OPU in the factory or service and invisible to the user.

Loader types:

- Tray Loader: JPL-2580 and 8829CD
- Slot Loader: JP3L33
- Top Loading: Traverse only

Each of a.m. Loaders can be set to operate with following Traverse/OPU combination:

- KHM313AAA or KHM313AAM
- SF-HD850 with DM3381P or DM3181P
- DA11 (option) requires special stuffing version.

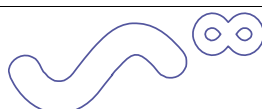

2 Block Diagram/System Architecture

Fig.1 Blockdiagram (standard version)

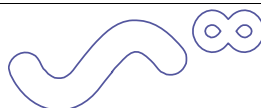
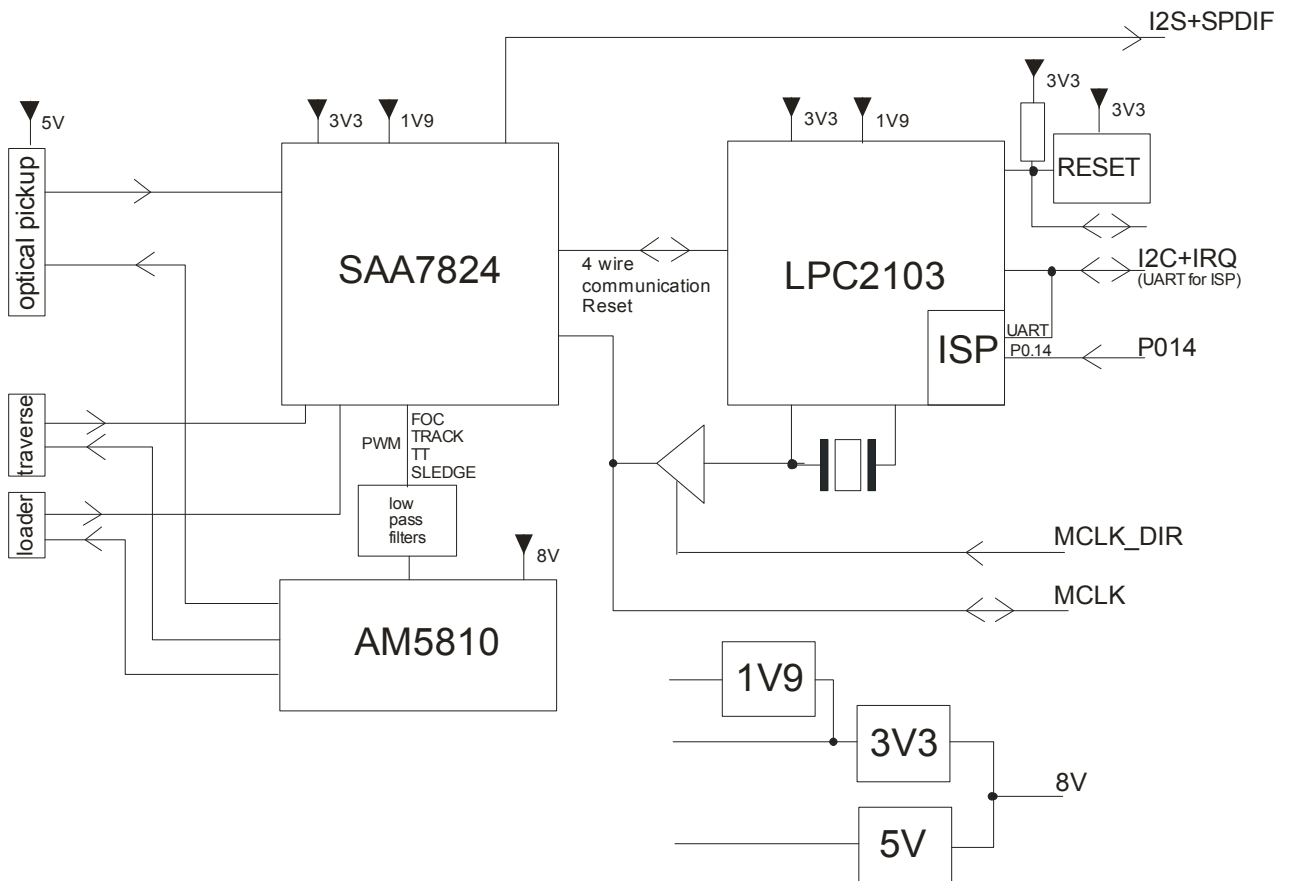

3 Physical specification

The PB is a two layer board in single sided reflow soldering. The material is UL certified FR4. Capacitors and resistors prevail in 0603 dimension.

The finished and stuffed CD-80 module is in compliance with European Community Directive 2002/95/EC (RoHS) and Chinas law “Administration on the Control of Pollution Caused by Electronic Information Product” (ACPEIP, sometimes referred to as “China RoHS”)

3.1 Dimensions

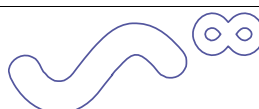
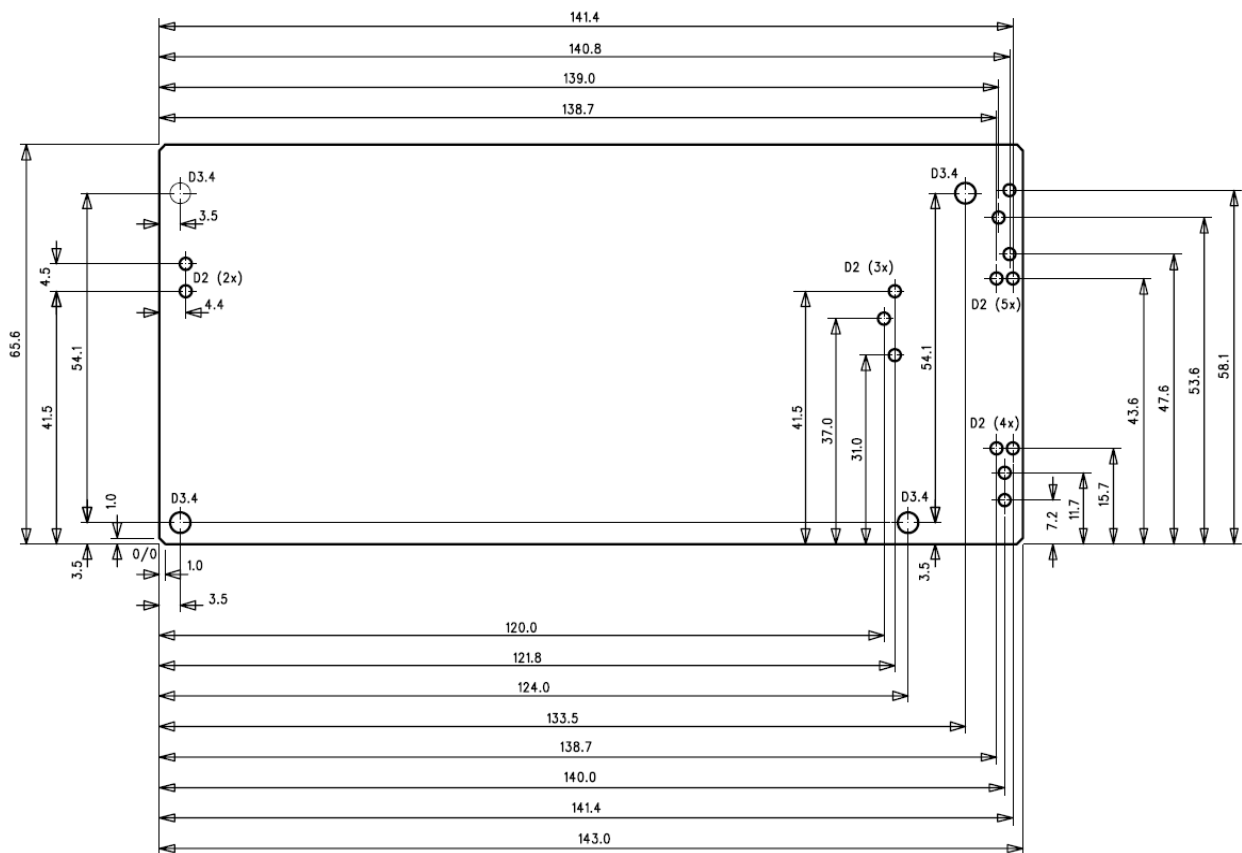

3.2 Layout

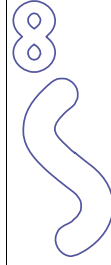
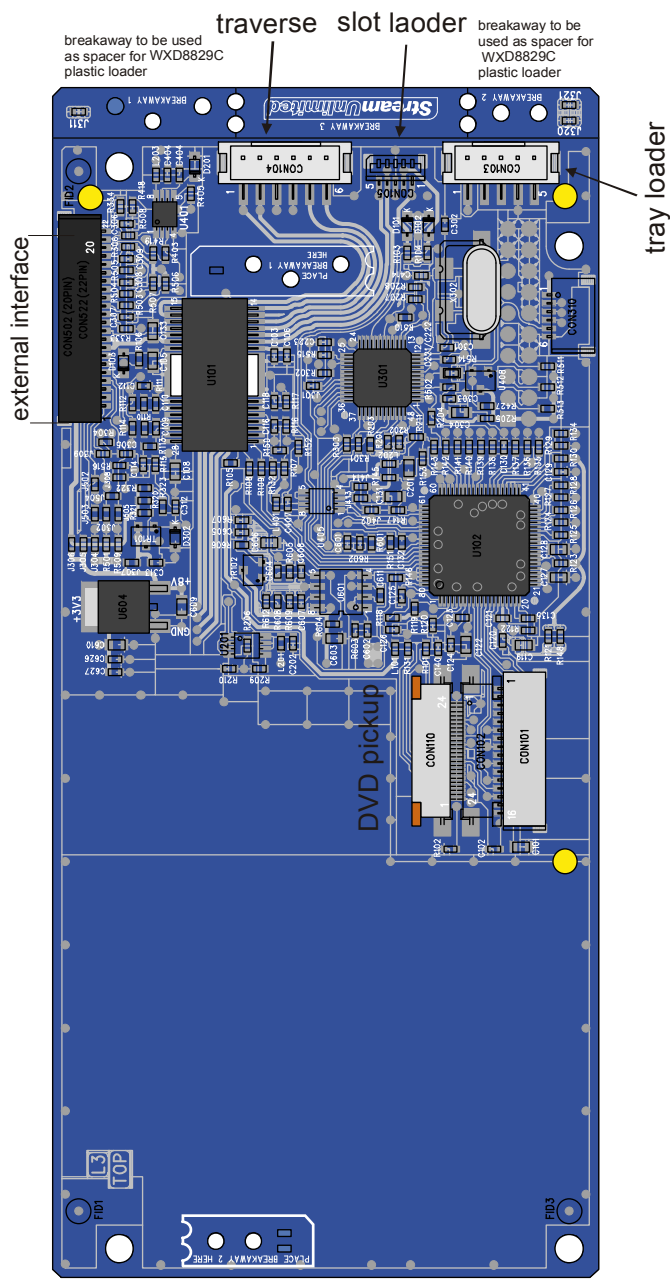

3.3 Stuffing versions

Connector		CD-80/10	CD-80/30
External Interface	FFC 20-way 1mm pitch side entry top contact	Yes	Yes
Slot loader	FFC 5-way 1mm pitch top entry	Yes	Yes
Tray loader	PH 5-way top entry	Yes	Yes
Traverse	PH 6-way top entry	Yes	Yes
DVD OPU	FFC 24-way 0.5mm pitch side entry top contact	Yes	No
CD OPU	FFC 16-way 1mm pitch side entry top contact	No	Yes

Note: The standard version is CD-80/10.

For CD-80/30, the pinning of the CD pickup connector matches to SANYO DA11 mechanism. Yet, the pinning of the traverse connector does not match to SANYO DA11, so a special crossover cable or interface board is required.

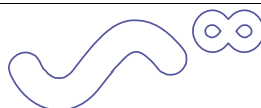

3.4 Interfaces

3.4.1 Signal specifications

LVTTTL	<p>Low voltage transistor-transistor logic (3.3V logic)</p> <p>Caution: Exceeding the absolute maximum rating will cause damage to the board.</p>	<p>Absolute maximum rating: $V_{IN} = -0.5V$ to $3.8V$ $V_{OUT} = -0.5V$ to $3.8V$ Maximum current drive: 4mA</p> <table border="1"> <thead> <tr> <th>Parameter</th> <th>Min</th> <th>Max</th> </tr> </thead> <tbody> <tr> <td>V_{IH} (V)</td> <td>2.0</td> <td>-</td> </tr> <tr> <td>V_{IL} (V)</td> <td>-</td> <td>0.8</td> </tr> <tr> <td>V_{OH} (V)</td> <td>2.4</td> <td>-</td> </tr> <tr> <td>V_{OL} (V)</td> <td>-</td> <td>0.4</td> </tr> </tbody> </table>	Parameter	Min	Max	V_{IH} (V)	2.0	-	V_{IL} (V)	-	0.8	V_{OH} (V)	2.4	-	V_{OL} (V)	-	0.4
Parameter	Min	Max															
V_{IH} (V)	2.0	-															
V_{IL} (V)	-	0.8															
V_{OH} (V)	2.4	-															
V_{OL} (V)	-	0.4															
I ² C	<p>Inter-IC All I²C signals at the board's connectors are LVTTTL levels.</p>	[I ² C_SPEC]															
I ² S	<p>Inter-IC Sound All I²S signals at the board's connectors are LVTTTL levels.</p>	see below timing for details															

I²S timing

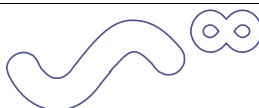
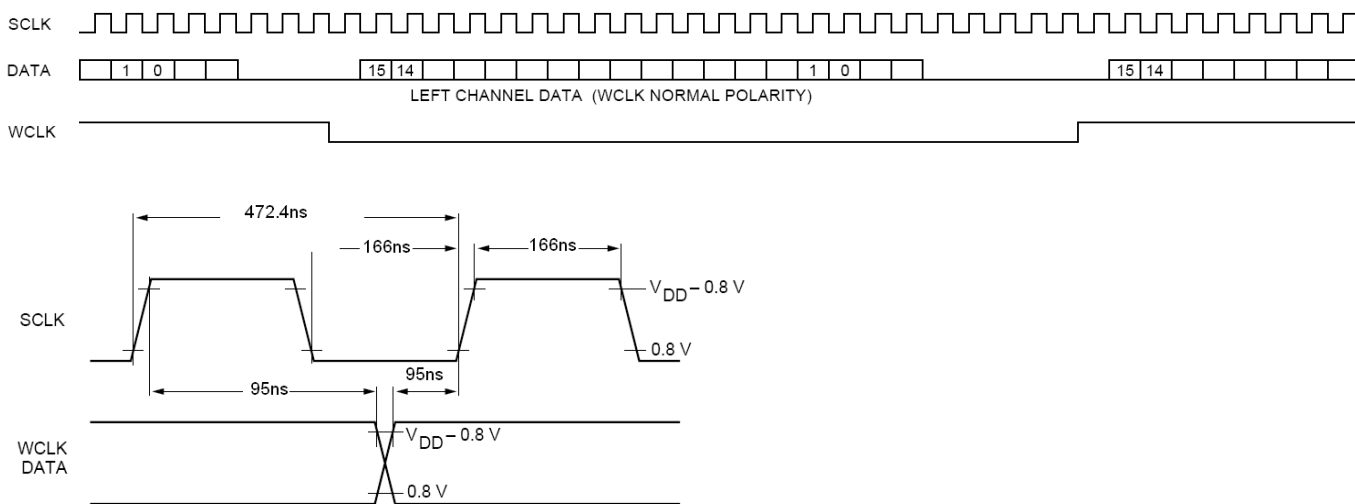

3.4.2 Connector types and wiring requirements

Connector	Type	Max wiring length
external interface	FFC 20-way 1mm pitch side entry top contact	150mm
Slot loader	FFC 5-way 1mm pitch top entry	250mm
Tray loader	PH 5-way top entry	250mm
Traverse	PH 6-way top entry	150mm
CD OPU	FFC 16-way 1mm pitch side entry top contact	200mm
DVD OPU	FFC 24-way 0.5mm pitch side entry top contact	200mm

The 24pin flatfoil cable to the DVD pickup must be of “BD” type, i.e. the contacts must be on the same side, thus connecting pin1 to pin24’.

3.4.3 External Interface connector

Pin	Assignment	Dir	Type	Description	internal pullup	logic
1	LPC_NRST	IO	LVTTTL open drain	reset input/output (wired NOR)	4k7 to 3V3	low in reset
2	LKILL	O	5V tolerant open drain	kill output to improve SNR on digital silence track	none	high on silence
3	P0.14	I	LVTTTL	when pulled low during reset period, LPC microcontroller will be forced to HW bootloader for firmware upgrade	10K to 3V3	force low for upgrade
4	RKILL	O	5V tolerant open drain	kill output to improve SNR on digital silence track	none	high on silence
5	MUTE	O	LVTTTL push pull	mute output for audio board muting stages, mute remains active until TOC read and music reproduction starts	none	high to mute
6	N.C.	-	-	this pin is not connected. HW provision for dual supply in products with weak 8V		
7	GND	-	GND	global GND. All GNDs connected onboard		
8	VCC	I	POWER	supply. 7 – 10V, nominal 8V		
9	VCC	I	POWER	supply. 7 – 10V, nominal 8V		
10	GND	-	GND	global GND. All GNDs connected onboard		
11	GND	-	GND	global GND. All GNDs connected onboard		
12	SPDIF	O	LVTTTL	Digital out. Buffer needed for coax output	none	
13	SCL	I	LVTTTL	I ² C clock input. 100kHz recommended.	2K7 to 3V3	
14	SDA	IO	LVTTTL	I ² C data line. CD-80 is I ² C slave	2K7 to 3V3	
15	IRQ	O	LVTTTL	request line from I ² C slave to I ² C master	2K7 to 3V3	low for request
16	CD_LRCK	O	LVTTTL	Digital audio I ² S – word clock, 44.1kHz		low for left
17	CD_SCK	O	LVTTTL	Digital audio I ² S – bit clock, 2.11MHz		
18	MCLK	IO	LVTTTL	Master clock input or output. 16.9344MHz		
19	CD_SDLR	O	LVTTTL	Digital audio I ² S – data, 16bit		
20	MCLK_DIR	I	LVTTTL	Masterclock direction		low for output

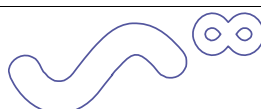

3.4.4 Slot Loader Connector (for JPSL-33)

Pin	Assignment	Direction	Type	Description
1	SW_CLOSE	Output	LVTTTL	Open switch
2	SW_OPEN	Output	LVTTTL	Close Switch
3	SW_ROOT	Output	GND	Common pin of Open and Close switch
4	MTR_NEG	Output	Power	Negative output of driver bridge
5	MTR_POS	Output	Power	Positive output of driver bridge

3.4.5 Tray Loader Connector (for JPSL-2580)

Pin	Assignment	Direction	Type	Description
1	MTR_POS	Output	Power	Positive output of driver bridge
2	MTR_NEG	Output	Power	Negative output of driver bridge
3	SW_OPEN	Output	LVTTTL	Open Switch
4	SW_ROOT	Output	GND	Common pin of Open and Close switch
5	SW_CLOSE	Output	LVTTTL	Close Switch

3.4.6 Traverse Connector

Pin	Assignment	Description
1	MSP_POS	Positive output of driver bridge for spindle/turntable motor
2	MSP_NEG	Negative output of driver bridge for spindle/turntable motor
3	Innerswitch	Innerswitch. If closed, pickup is fully inside
4	GND	GND for innerswitch
5	MSL_NEG	Negative output of driver bridge for sledge/slider motor
6	MSL_POS	Positive output of driver bridge for sledge/slider motor

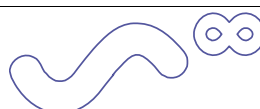

3.4.7 CD OPU Connector

Pin	Assignment	Direction	Type	Description
1	FCS_NEG	Output	Power	Positive output to focus actuator
2	TRK_POS	Output	Power	Positive output of track actuator
3	TRK_NEG	Output	Power	Negative output of track actuator
4	FCS_POS	Output	Power	Negative output to focus actuator
5	PD_MON	Input	Analogue	Laser Monitor Diode
6	VR	Input	Analogue	ALPC potentiometer
7	LD	Output	Analogue	Laser Diode
8	GND	-	-	OPU Ground
9	F	Input	Analogue	Satellite Diode 1
10	C	Input	Analogue	Central Diode C
11	B	Input	Analogue	Central Diode B
12	A	Input	Analogue	Central Diode A
13	D	Input	Analogue	Central Diode D
14	E	Input	Analogue	Satellite Diode 2
15	V _{cc}	Output	Power	Power supply for OPU
16	V _{ref}	Output	Power	Reference voltage for PD-IC

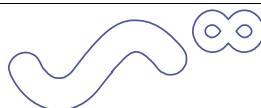

3.4.8 DVD OPU Connector

Pin /10,	Pin /11	Assignment	Direction	Type	Description
1	24	GND_LD	-	-	Laser diode Ground
2	23	DVD_LD	-	-	Connected to Ground
3	22	N/C	-	-	
4	21	N/C	-	-	
5	20	PD_MON	Input	Analogue	Laser Monitor Diode
6	19	CD_LD	Output	Analogue	CD Laser Diode
7	18	DVD_VR	-	-	
8	17	CD_VR	Input	Analogue	ALPC potentiometer for CD
9	16	N/C	-	-	
10	15	E	Input	Analogue	Satellite Diode 2
11	14	V _{cc}	Output	Power	Power supply for OPU
12	13	V _{ref}	Output	Power	Reference voltage for PD-IC
13	12	GND	-	-	OPU Ground
14	11	F	Input	Analogue	Satellite Diode 1
15	10	B/b	Input	Analogue	Central Diode B
16	9	A/a	Input	Analogue	Central Diode A
17	8	RF	Output	Analogue	RF signal
18	7	SW_DVD/CD	Output	-	Connected to V _{cc}
19	6	D/d	Input	Analogue	Central Diode D
20	5	C/c	Input	Analogue	Central Diode C
21	4	TRK_NEG	Output	Power	Negative output of track actuator
22	3	TRK_POS	Output	Power	Positive output of track actuator
23	2	FCS_POS	Output	Power	Negative output to focus actuator
24	1	FCS_NEG	Output	Power	Positive output to focus actuator

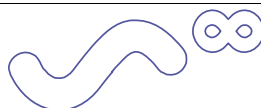

4 Playability

4.1 Media

No	Media	Data type	Remark
5.1.1	CDDA	CD digital audio	Including CD text and "copy protected" CD
5.1.2	Hybrid SACD	CD layer	
5.1.3	CDR/CDRW	CD digital audio	

4.2 Test discs

No	Test disc	Item	Remark
5.3.1	SBC444A track 7	Wedge 600µm	No audible disturbances
5.3.2	SBC444A track 14	Black dot 600µm	No audible disturbances
5.3.3	SBC444A track 19	Fingerprint	No audible disturbances
5.3.4	Subchassis 8A track 8	Bad RF	No audible disturbances and fast searching check
5.3.5	Subchassis 8A track 15	Maximum read out diameter	Check the max. diameter read out performance.
5.3.6	Philips 8cm 0.6 deg skew disc tracks 1 and 6	Skew	Start up and play with the first 10mins. Check 4 positions each 90deg turned from the previous
5.3.7	TDC-732RA vertical deviation disc. First and last track	Vertical deviation	No failure during startup and play. Check 4 positions each 90 deg turned from the previous
5.3.8	Philips Eccentricity disc. First and last track	Eccentricity 150µm	No failure during startup and play. Check 4 positions each 90 deg turned from the previous
5.3.9	CDRW SBC444A track13	Black dot	No audible disturbances
5.3.10	CDRW SBC444A track17	Fingerprint	No audible disturbances
5.3.11	CDRW high reflection. First and last track	High reflection	No audible disturbances
5.3.12	CDRW low reflection. First and last track	Low reflexion	No audible disturbances

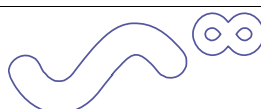

5 Application information

5.1 Power cycle timing

The CD-80 board operates in power-off and power-on mode only. There is no standby mode at board level. In power-off mode, the board does not respond to any communication or signals. As the pull-ups for the I²C bus are located on CD-80 board, it is not recommended to share the bus with other devices, which need to be powered while CD-80 is off.

Reset of the board is via an internal reset circuit, which is tied to the 3V3 supply. The reset will be activated immediately in case of a dip on VCC below about 5V. Note the delay at power on. To reset the board externally, use an open drain output on nRESET line.



5.2 Absolute maximum ratings

Voltage name	Minimum input voltage ($V_{ABS\ MIN} / V$)	Maximum input voltage ($V_{ABS\ MAX} / V$)
8V	-0.5	12V

Note, that operating CD-80 at a supply more than 10V will not cause functional problems immediately, but causes thermal stress to the voltage regulators and the servo driver IC and should thus be avoided.

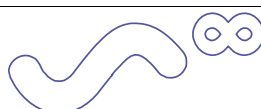

5.3 Power requirements

operation mode	average current consumption [mA]	peak current consumption [100ms measurement interval]
stop	200	
play	350	
open/close		500
track skip		1500

The supply concept is optimized for easy integration into a product. All GNDs are connected together on board level. If there is a separate power GND available in the application, it is beneficial to use pin 11 as digital GND.

5.4 Safety

CD-80 complies to IEC 60065 under following supply conditions:

8V level within specified range (7-10V)

8V current limited to 3A or less

for deviating supply conditions, the compliance has to be re-evaluated during product development

5.5 Muting concept, output data validity

CD-80 will output SPDIF signal as long as the supply is on.

When using internal Master Clock mode, the Master Clock will also be output permanently.

I2S signals are switched on after the first command has been received from the frontpanel (AC_Set_Loader). But during TOC reading of a disk, the I2S signals need to be switched to high impedance. If a disk is loaded, the I2S lines will become valid again when TOC has been read.

This method does not cause problems with most DACs, in case, the DAC used in the application produces some clicks when switching WCLK and SCLK signals off and back on, the mute line provided by CD-80 may be used to overcome any audible interference. See below diagram on signals for the case, that the unit is switched on with a disk loaded already, then the disk is removed and the tray; after trying to read the TOC without a disk loaded, the tray is opened and a new disk is loaded, TOC is being read and the disk is played.

Note: the mute line will be high impedance while the onboard microcontroller is in reset, so the line can be pulled high by an external logic at power on.

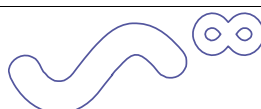

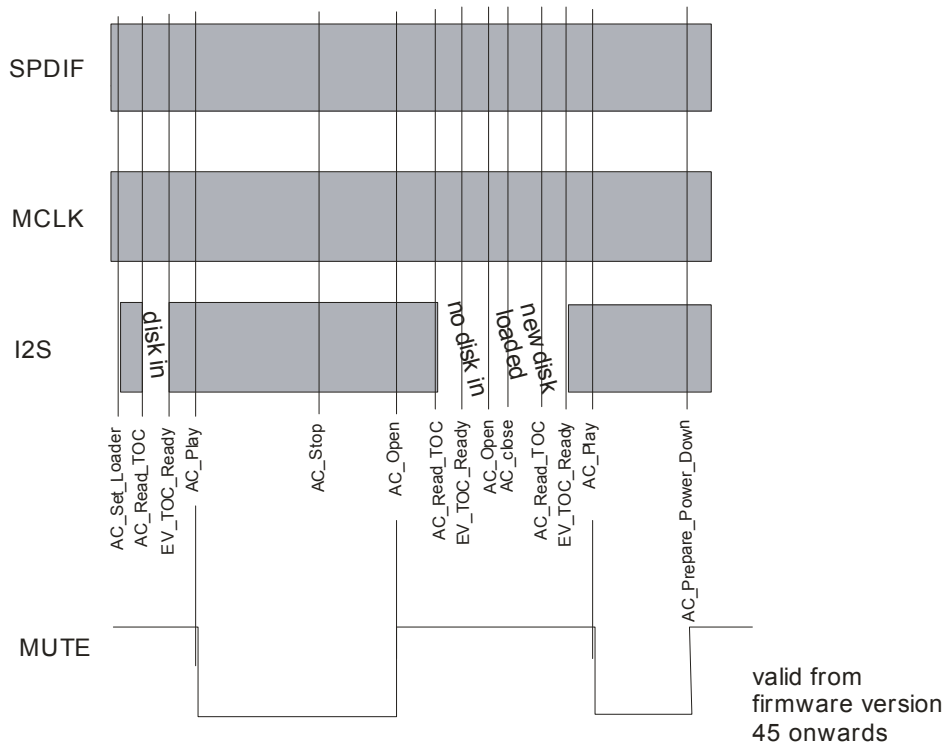

5.6 Operating temperature range

Performance specification valid for 25°C ambient temperature.

CD-80 will work between -10°C and 60°C.

Please note, that optical pickups used with CD-80 may have a lower operating temperature range, as the laser lifetime is highly dependent on temperature.

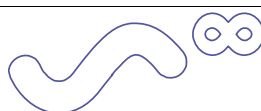

6.1 EMC

CD-80 will meet legal emission limits when used inside a metal application with reasonably sized openings for display etc. Main disturbance originates from the external Masterclock and I²S lines, so care has to be taken to reduce coupling of the cables and attached boards to the outside world and keep the 20pin flatfoil cable as short as possible which will also reduce crosstalk between the signals that pass over the flatfoil.

6.2 ESD

Although CD-80 board is not very critical w.r.t. ESD when operated in a finished product, special care has to be taken during assembly to avoid damage of either the board or the pickup of the mechanism.

The laser diode of a pickup is extremely sensitive to ESD when the connections are floating. This is especially relevant for a DVD pickup, where the laser is operated in pulsed mode and thus cannot be protected by a large capacitor in parallel on the pickup.

Following precautions thus must be taken when connecting a pickup to CD-80:

- Make sure, that the flatfoil to the pickup is inserted while the supply is off.
- Do not touch the exposed conductive strips of the flatfoil when inserting.
- ESD precautions have to be taken when touching the flatfoil, as there is a danger to damage the pickup laser.
- During transportation of the pickup and traverse, the laser is protected by a short circuit formed by a drop of solder on the pickup flexprint. As a DVD mechanism has two lasers, such pickups must have both lasers shorted during transportation either by two separated or a combined drop of solder. This solder drop must be removed **AFTER** connecting the flatfoil to CD-80 board. A soldering iron with the tip connected to ESD GND must be used for this purpose!

