

SCDS Series

Features

- RoHS, Halogen Free and REACH Compliance
- Magnetic shielded
- Various package size and wide inductance range

Applications

- AP Routers
- STBs
- LCD TVs and monitors
- Game consoles
- LED lightings
- DC/DC converters

Product Identification

SCDS

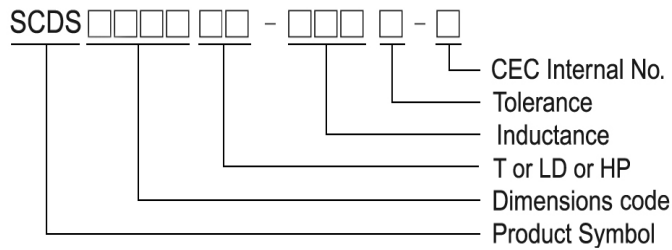

- T : Packaging: Tape and Reel
- HP : High Power
- LD : Low DCR
- CEC Internal No.: S: Base type terminals

SCDS3D16

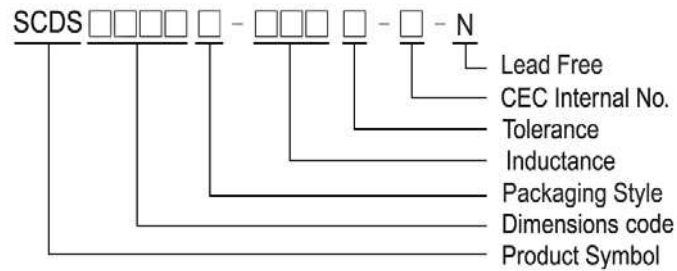

SCDS2D11/2D14/2D18LD/ 2D18HP

Shape and Dimensions

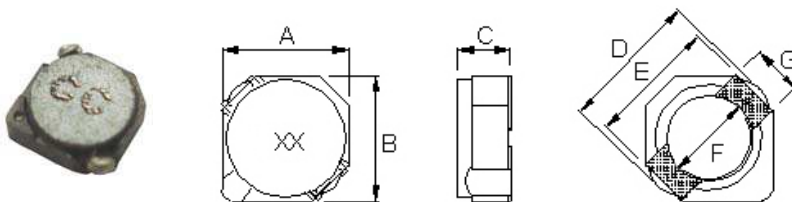

Dimension in mm

TYPE	A	B	C	D	E	F	G
SCDS2D11	3.2 ⁺⁰	3.2 ⁺⁰	1.2 ⁺⁰	4.5 ⁺⁰	3.3	2.1	1.0
SCDS2D14	3.2 ⁺⁰	3.2 ⁺⁰	1.55 ⁺⁰	4.5 ⁺⁰	3.3	2.1	1.0
SCDS2D18LD	3.2 ⁺⁰	3.2 ⁺⁰	2.0 ⁺⁰	4.5 ⁺⁰	3.3	2.1	1.0
SCDS2D18HP	3.2 ⁺⁰	3.2 ⁺⁰	2.0 ⁺⁰	4.5 ⁺⁰	3.3	2.1	1.0

Recommended Pattern

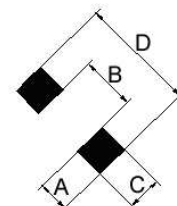

Dimensions in mm

TYPE	A	B	C	D
SCDS2D11	1.3	1.7	1.3	4.3
SCDS2D14	1.3	1.7	1.3	4.3
SCDS2D18LD	1.3	1.7	1.3	4.3
SCDS2D18HP	1.3	1.7	1.3	4.3

SMD Shielded Power Inductors - SCDS Series

SCDS3D11/3D11HP

Shape and Dimensions

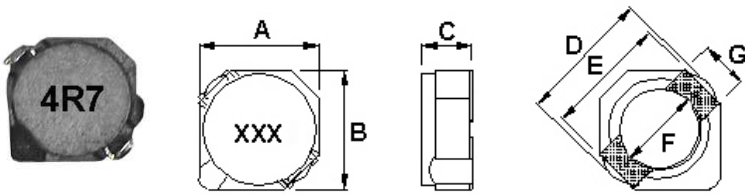

Dimension in mm

TYPE	A	B	C	D	E	F	G
SCDS3D11	4 ⁺⁰	4 ⁺⁰	1.2 ⁺⁰	5.2 ⁺⁰	4.4	2.8	1.1
SCDS3D11HP	4 ⁺⁰	4 ⁺⁰	1.2 ⁺⁰	5.2 ⁺⁰	4.4	2.8	1.1

Recommended Pattern

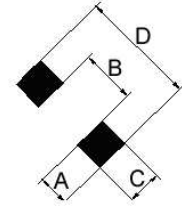

Dimensions in mm

TYPE	A	B	C	D
SCDS3D11	1.4	2.4	1.5	5.2
SCDS3D11HP	1.4	2.4	1.5	5.2

SCDS 3D16T-XXX-S1-N

Shape and Dimensions

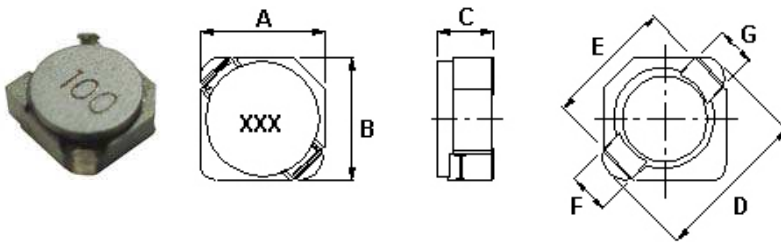

Dimensions in mm

TYPE	A	B	C	D	E	F	G
SCDS3D16	4 ⁺⁰	4 ⁺⁰	1.8 ⁺⁰	5.2 ⁺⁰	4.4Typ	1.4 ⁺⁰	1.1Typ

Recommended Pattern

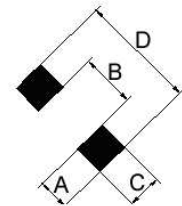

Dimension in mm

TYPE	A	B	C	D
SCDS3D16	1.4	2.4	1.5	5.2

SCDS3D28/3D28LD

Shape and Dimensions

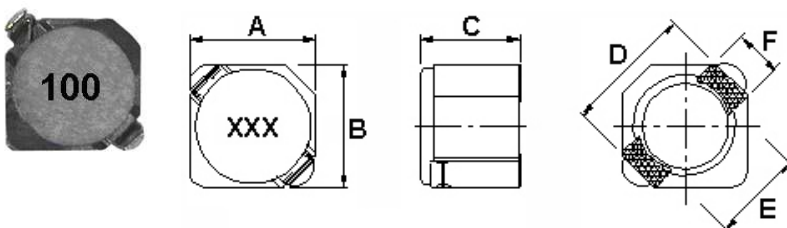

Dimension in mm

TYPE	A	B	C	D	E	F
SCDS3D28	4 ⁺⁰	4 ⁺⁰	3 ⁺⁰	4.4	2.8	1.1
SCDS3D28LD	4 ⁺⁰	4 ⁺⁰	3 ⁺⁰	4.4	2.8	1.1

Recommended Pattern

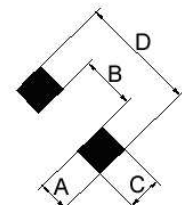

Dimensions in mm

TYPE	A	B	C	D
SCDS3D28	1.4	2.4	1.5	5.2
SCDS3D28LD	1.4	2.4	1.5	5.2

SMD Shielded Power Inductors - SCDS Series

Standard Specifications

Stamp	Inductance (μ H)	RDC (m Ω) Max								
		SCDS 2D11	SCDS 2D14	SCDS 2D18LD	SCDS 2D18HP	SCDS 3D11	SCDS 3D11HP	SCDS 3D16	SCDS 3D28	SCDS 3D28LD
R60	0.6						59			
1R0	1.0							40		
1R2	1.2						82			
1R5	1.5	68	63				104	52		
1R7	1.7				44					
1R8	1.8		75							
2R2	2.2	98	94	41	60		143	72		
2R7	2.7		106			78				
3R3	3.3	123	125	54	86		182	85	72.1	
3R9	3.9		138							
4R7	4.7	170	169	78	140	123	234	105	88.3	
5R6	5.6		188					135		
6R3	6.3				160					
6R8	6.8	260	213	106		180	377	170	119	
8R2	8.2		281			204				
100	10	400	294	180	245	240	413	210	145	95
120	12		394			276	585			100
150	15			220	345	372	653	295	213	115
180	18					468	888			125
220	22			320		540	1010	430	335	145
270	27					726				175
330	33			460		822		675	481	215
390	39					942				225
470	47			660					599	305
560	56									325
680	68									470
820	82									540
101	100							2750		610
121	120									755
151	150									880
181	180									1130
221	220									1270

Test Freq. (L): SCDS 2D11/ 2D14/ 2D18LP/2D18HP/3D11/3D11HP/3D28/3D28LD (100KHz/ 1V)
SCDS 3D16 (100KHz/ 0.1V)

Other type: Rated current: Isat DC current (A) that will cause L to drop approximately 35% of it's nominal value or D.C. current when the temperature rising $\Delta t=40^{\circ}\text{C}$ lower, whichever is lower.

Test Instrument: L: Agilent/ E4980 or HP4284A

RDC: CH502BC

Rated Current: HP4284+42841A or WK3260B+WK3265B

SMD Shielded Power Inductors - SCDS Series

Standard Specifications

Stamp	Inductance (μ H)	Rated Current (A)								
		SCDS 2D11	SCDS 2D14	SCDS 2D18LD	SCDS 2D18HP	SCDS 3D11	SCDS 3D11HP	SCDS 3D16	SCDS 3D28	SCDS 3D28LD
R60	0.6						2.90			
1R0	1.0							1.60		
1R2	1.2						2.00			
1R5	1.5	0.90	1.80				1.85	1.55		
1R7	1.7				1.85					
1R8	1.8		1.65							
2R2	2.2	0.78	1.50	0.85	1.60		1.60	1.20		
2R7	2.7		1.35			0.53				
3R3	3.3	0.60	1.20	0.75	1.45		1.25	1.10	2.00	
3R9	3.9		1.10							
4R7	4.7	0.50	1.00	0.63	1.20	0.40	1.00	0.90	1.65	
5R6	5.6		0.95					0.80		
6R3	6.3				1.05					
6R8	6.8	0.44	0.85	0.52		0.34	0.85	0.73	1.24	
8R2	8.2		0.80			0.32				
100	10	0.35	0.70	0.43	0.85	0.28	0.80	0.55	1.05	0.50
120	12		0.62			0.25	0.64			0.45
150	15			0.35	0.70	0.23	0.58	0.45	0.90	0.40
180	18					0.21	0.52			0.35
220	22			0.30		0.19	0.45	0.40	0.76	0.33
270	27					0.17				0.29
330	33			0.24		0.15		0.32	0.58	0.28
390	39					0.14				0.25
470	47			0.20					0.48	0.23
560	56									0.20
680	68									0.185
820	82									0.172
101	100							0.13		0.160
121	120									0.136
151	150									0.124
181	180									0.119
221	220									0.116

Tolerance Of Inductors

- SCDS 2D11 1.5 ~ 10 μ H \pm 30%
- SCDS 2D14 1.5 ~ 12 μ H \pm 30%
- SCDS 2D18LD 2.2 ~ 47 μ H \pm 30%
- SCDS 2D18HP 1.7 ~ 15 μ H \pm 30%
- Tolerance : M = \pm 20% , T = \pm 30% , N = $^{+40}_{-20}$ %
- SCDS3D11 2.7 ~ 39 uH \pm 30%
- SCDS3D11HP 0.6 ~ 22 uH \pm 30%
- SCDS3D16 1.0 ~ 100 uH \pm 30%
- SCDS3D28 3.3 ~ 47 uH \pm 30%
- SCDS3D28LD 10 ~ 220 uH \pm 30%

SMD Shielded Power Inductors - SCDS Series

Packaging Specifications

Tape Dimensions

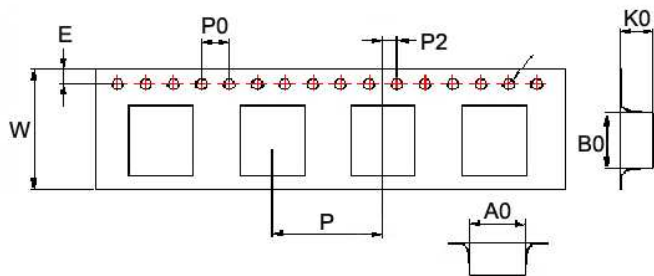

Tape Material

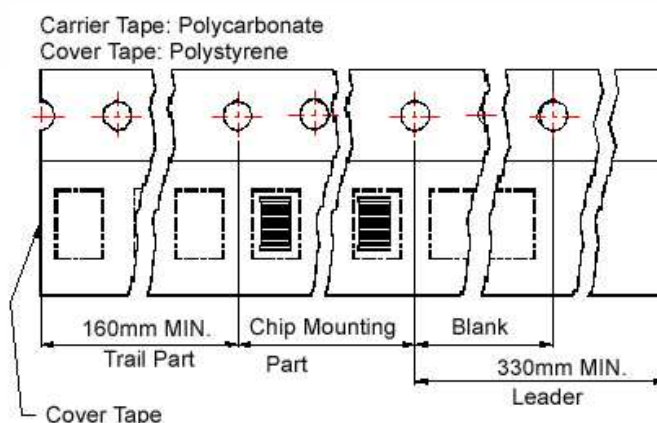

Reel Dimensions

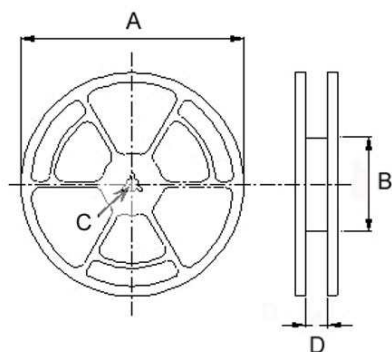

Dimensions in mm

TYPE	Tape Dimensions									Reel Dimensions				Quantity PCS / REEL
	A0	B0	K0	D	E	W	P	P0	P2	A	B	C	D	
SCDS 2D11	3.35	3.35	1.4	1.55	1.75	12	8	4	2	178	60	13	13.2	1000
SCDS 2D14	3.35	3.35	1.7	1.55	1.75	12	8	4	2	178	60	13	13.2	1000
SCDS 2D18	3.5	3.5	2.1	1.55	1.75	12	8	4	2	178	60	13	13.2	1000
SCDS 3D11	4.2	4.2	1.5	1.55	1.75	12	8	4	2	178	60	13	13.2	1000
SCDS 3D16	4.1	4.1	2.0	1.5	1.75	12	8	4	2	178	60	13	13.2	1000
SCDS 3D28	4.2	4.2	3.2	1.55	1.75	12	8	4	2	178	60	13	13.2	500