

M1040

10.4" Intel® Atom™ N450 Mobile Clinical Assistant



Features

- eHealthcare and Clinical Assistant Application
- Soldered onboard Intel® Atom™ Processor N450
- Electromagnetic Digitizer with Resistive Touch
- EN60601-1 & EN60601-1-2 Certified
- Redundant Battery (Internal + Hot-swappable External Battery) w/ Long Battery Life (6.5hrs Max.)
- Slim Appearance - Ultra-light Weight (1.3kg) and Ultra-slim (26mm); Slip-free Grip for Easy Handling
- Multi-connectivity (Bluetooth, WLAN)
- 2D Barcode Scanner, 2.0 Megapixels Camera, RFID Reader
- Multi-expansion (1 x RS-232, 1 x USB, 1 x LAN, 1 x VGA and 1 x SmartCard)

System

CPU	Soldered onboard Intel® Atom™ Processor N450 1.6GHz
Graphics Controller	Intel® GMA3150
Memory	2GB DDR2 SO-DIMM memory module installed
Chipset	Intel® ICH8M
Storage	32GB 1.8" SATA SSD installed

Peripherals and Devices

Camera	1 x 2.0 MP CMOS camera (front)
	1 x 2.0 MP CMOS camera w/ auto-focus (back) (optional)
RFID	1 x Integrated 13.56MHz RFID reader with ISO 14443A/14443B/15693 support (optional)
WLAN	1 x 802.11 b/g/n Mini PCIe Wireless LAN card
GSM/UMTS	Up to HSPA 3.75G (optional)
Bluetooth	1 x Bluetooth 2.1+EDR module (optional)
Barcode Scanner	1 x 2D Barcode Scanner (optional)
Smart Card Reader	1 x Smart Card Reader (optional)

I/O Interface

Audio	2 x Integrated 2W speakers, 1 x built-in Microphone
USB Port	1 x USB 2.0 port
Docking Port	1 x 35-pin POGO connector to expand USB, VGA & GbE

Button & Indicator

Button	1 x Power on/off button with indicative LED ring
	1 x 5-way function key
	1 x RFID on/off button
	1 x Barcode scan trigger button
Indicator	4 x Programmable function keys (F1 ~ F4) Default setting: referring to User Manual
	1 x Battery status LED
	1 x Bluetooth LED
	1 x WLAN/RFID on/off LED
Reset Function	1 x Power on/off LED
Reset Function	1 x hardware reset

Touch Screen

Type	Digitizer with Resistive Touch
Touch Pen	Battery-free pen

LCD Display

Size/Type	10.4" TFT Active Matrix Panel
Max. Resolution	1024 x 768 (XGA) w/ 262,144 colors
Luminance	340 cd/m ² (typ.)
Contrast Ratio	600:1 (typ.)
View Angle (U/D/R/L)	89°/89°/89°/89°
Backlight Type	LED

Power Requirement

Adapter Input	100 ~ 240 VAC (Full Range)
Adapter Output	20VDC, 3A, 60W with medical certificate
Battery Type	Li-battery pack
Battery Capacity	Internal 1880mAh 3-cell
	External 1880mAh 4-cell
Battery Operating Time	6.5 hours (Max.)

Mechanical & Environmental

Operating Temp.	0 ~ 40°C (32 ~ 104°F)
Storage Temp.	-20 ~ 60°C (-4 ~ 140°F)
Operating Humidity	10 ~ 95% @ 40°C (non-condensing)
Dimensions (W x D x H)	256 x 26 x 255 mm (10.08" x 1.02" x 10.04")
Net Weight	1.3 kg (2.87 lb) w/ batteries (internal + external)
Regulatory	CE, FCC Class B
	EN60601-1, EN60601-1-2, certified
IP Rating	IP54
Vibration	5 ~ 500Hz, 3G random operation
Shock	30G peak (11m/sec)
Transit Drop	Under 3ft (90cm)
Operational Altitude	below 2000m

OS Support

Windows Embedded 7 / Windows 7 Professional
Windows XP Embedded / Windows XP Professional
Ubuntu and Fedora Linux compliant

Ordering Information



M1040	10.4" MCA tablet with resistive Touchscreen, WiFi, front camera, dual batteries
-------	---



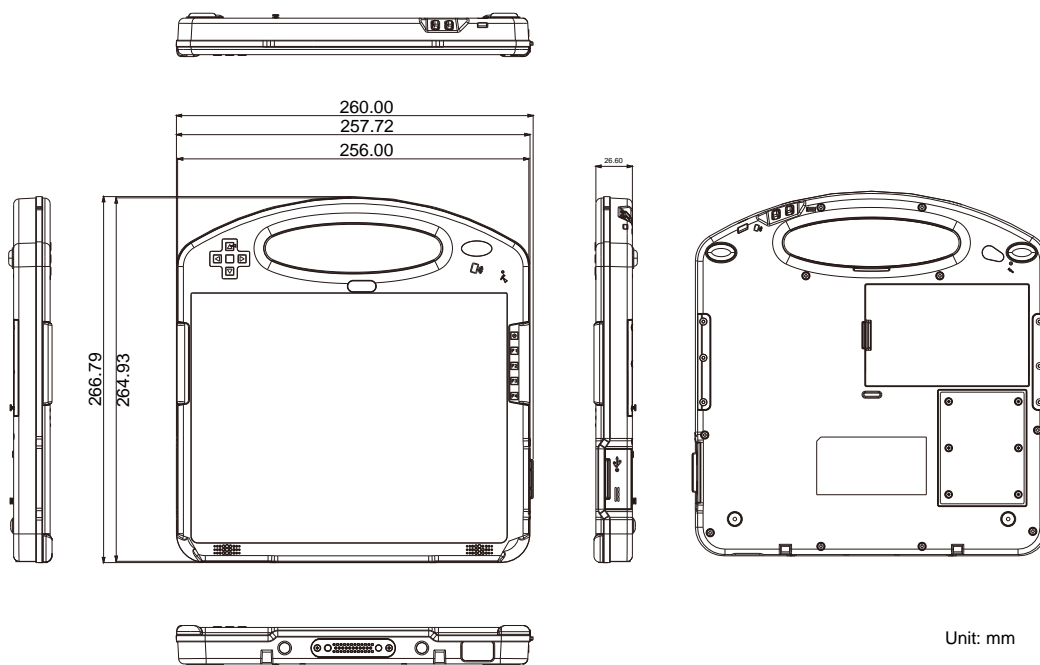





Dimensions



Standard Accessories







PAC-M060W	60W medical-grade AC/DC adapter kit	
HSK-1040	Hand strap kit	

Optional Accessories

eBAT-1040	4-cell 1880mAH external battery kit	
DGT-1040	10.4" digitizer with battery-free pen	
VMC-1040	Vehicle-mount cradle	
DMK-1040	Bracket to convert VMC-1040 to the desktop type	
DTC-1040	Desktop cradle	
VSB-1040	VESA-mount bracket to adapt the computer to VMC-1040	

Optional Configuration (CTOS* Kit)

(Not Sold Separately)

CamR-1040	2M camera kit (rear) w/ AF	
SMR-1040	Smart card reader module kit	
RFID-1040	RFID module kit	
BarC-1040	Barcode scanner module kit	
HSUPA-1040	HSUPA 3.75G module kit	
BT-1040	Bluetooth module kit	

*CTOS means Configure-to-Order Service.