

## MR16 Spot with Luxeon 3W LED's

### Specifications







Voltage	12V
Power	3W
Viewing angle	80° & 120°
Operating Temperature	-20°~+40°C

### Benefits

High luminance  
Small size and easy replacement of halogen lamps  
Low power consumption  
Long lifetime



### Electrical and Optical Characteristics (Ta=25°C)

Part-Number	Colour	Colour Temperature	Intensity lm	Angle
MR16-N31080	 warmwhite	2540°-3500°K	125	80°
MR16-N31120	 warmwhite	2540°-3500°K	125	120°
MR16-S31080	 naturalwhite	3500°-4500°K	200	80°
MR16-S31120	 naturalwhite	3500°-4500°K	200	120°
MR16-W31080	 white	4500°-10000°K	200	80°
MR16-W31120	 white	4500°-10000°K	200	120°

### Dimensions

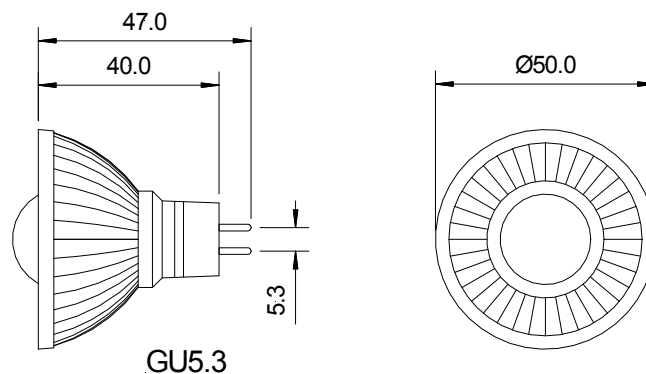

- All specifications according to information from our manufacturers, without additional guarantee on our part
- All dimensions are in millimetres.
- Tolerance is  $\pm 0.25$ mm unless otherwise specified.
- Specifications are subject to change without notice