



INNOVATIVE DISPLAY TECHNOLOGIES

17171 MURPHY AVENUE

IRVINE, CALIFORNIA 92614-5915

P: 949-417-8070/F: 949-417-8075

E-mail: info@shellyinc.com

Website: www.shellyinc.com

Specification

Part Number : SOG12806432-BTN-BWLW

Customer :

APPROVED BY: (FOR CUSTOMER USE ONLY)	PCB VERSION:	DATE:
--	---------------------	--------------

SOLD BY	APPROVED BY	CHECKED BY	ISSUE DATE

MODLE NO :

RECORDS OF REVISION

DOC. FIRST ISSUE

VERSION	DATE	REVISED PAGE NO.	SUMMARY
0	2008/10/7		First issue

Contents

1. Module Classification Information
2. Precautions in use of LCD Modules
3. General Specification
4. Absolute Maximum Ratings
5. Electrical Characteristics
6. Optical Characteristics
7. Interface Pin Function
8. Contour Drawing & Block Diagram
9. Timing Characteristics
10. Reliability
11. Backlight Information
12. Inspection specification
13. Material List of Components for RoHs

2.Precautions in use of LCD Modules

- (1) Avoid applying excessive shocks to the module or making any alterations or modifications to it.
- (2) Don't make extra holes on the printed circuit board, modify its shape or change the components of LCD module.
- (3) Don't disassemble the LCM.
- (4) Don't operate it above the absolute maximum rating.
- (5) Don't drop, bend or twist LCM.
- (6) Soldering: only to the I/O terminals.
- (7) Storage: please storage in anti-static electricity container and clean environment.
- (8). The factory reserves the right to change the passive components
- (9). The factory reserves the right to change the PCB Rev.

3.General Specification

Item	Dimension	Unit
Number of Characters	128 x 64 dots	-
Module dimension	90.0x 131.7 x6.6(MAX)	mm
View area	70.7 x 38.8	mm
Active area	66.52 x 33.24	mm
Dot size	0.48 x0.48	mm
Dot pitch	0.52 x 0.52	mm
LCD type	FSTN Positive, Transflective (In LCD production, It will occur slightly color difference. We can only guarantee the same color in the same batch.)	
Duty	1/64 , 1/9 Bias	
View direction	6 o'clock	
Backlight Type	LED White	

4. Absolute Maximum Ratings

Item	Symbol	Min	Typ	Max	Unit
Operating Temperature	T_{OP}	-20	-	+70	°C
Storage Temperature	T_{ST}	-30	-	+80	°C
Input Voltage	V_I	-0.3	-	$V_{DD}+0.3$	V
Supply Voltage For Logic	$V_{DD}-V_{SS}$	-0.3		5.0	V
LCD Driver Supply Voltage	V_{OUT}	4		13	V

5. Electrical Characteristics

Item	Symbol	Condition	Min	Typ	Max	Unit
Supply Voltage For Logic	$V_{DD}-V_{SS}$	-	3.0	3.3	3.6	V
Supply Voltage For LCM	$V_{DD}-V_5$	$T_a=-20^{\circ}\text{C}$	10.0	10.2	10.4	V
		$T_a=25^{\circ}\text{C}$	9.8	10.0	10.2	V
		$T_a=70^{\circ}\text{C}$	9.6	9.8	10.0	V
Input High Volt.	V_{IH}	-	$0.8 V_{DD}$	-	V_{DD}	V
Input Low Volt.	V_{IL}	-	V_{SS}	-	$0.2 V_{DD}$	V
Output High Volt.	V_{OH}	-	$0.8 V_{DD}$	-	V_{DD}	V
Output Low Volt.	V_{OL}	-	V_{SS}	-	$0.2V_{DD}$	V
Supply Current(No include LED Backlight)	I_{DD}	$V_{DD}=3.3\text{V}$		0.6	1	mA

6. Optical Characteristics

Item	Symbol	Condition	Min	Typ	Max	Unit
View Angle	(V) θ	CR \geq 2	30	-	60	deg
	(H) ϕ	CR \geq 2	-45	-	45	deg
Contrast Ratio	CR	-	-	5	-	-
Response Time	T rise	-	-	200	300	ms
	T fall	-	-	250	350	ms

Definition of Operation Voltage (Vop)

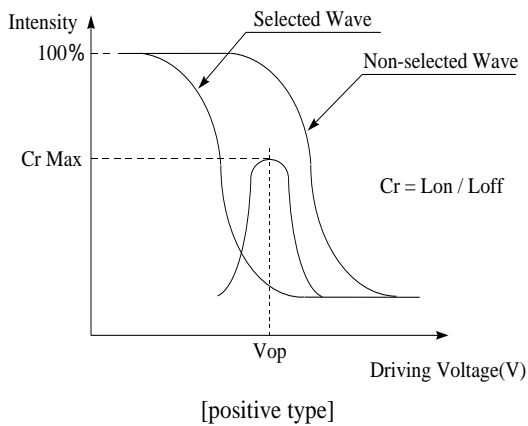

Definition of Response Time (Tr, Tf)

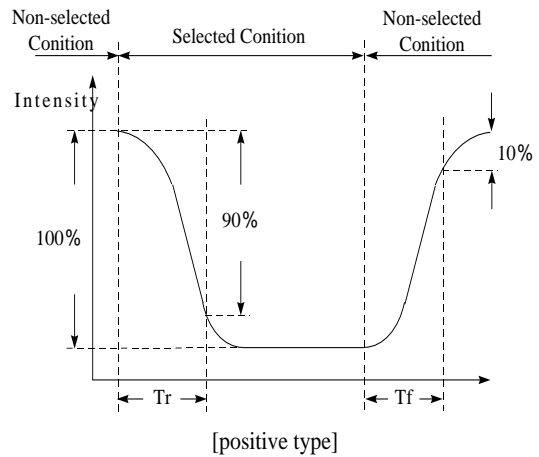

Conditions:

Operating Voltage : Vop

Viewing Angle(θ , ϕ) : 0° , 0°

Frame Frequency: 64 HZ

Driving Waveform: 1/N duty, 1/a bias

Definition of viewing angle CR \geq 2)

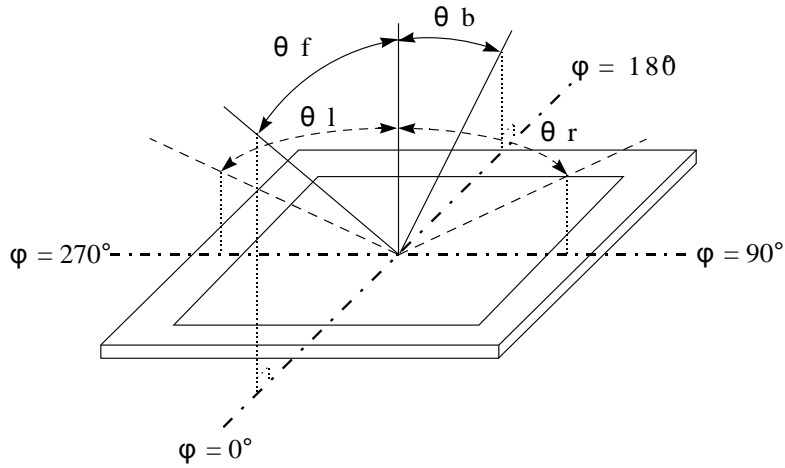

7.Interface Pin Function

Pin No.	Symbol	Level	Description
1	/CS1		This is the chip select signal. When /CS1 = " L" , then the chip select becomes active, and data/command I/O is enabled.
2	/RES		When /RES is set to " L" , the settings are initialized.
3	A0		This is connected to the least significant bit of the normal MPU address bus, and it determines whether the data bits are data or a command. A0 = " H" : Indicates that D0 to D7 are display data. A0 = " L" : Indicates that D0 to D7 are control data.
4	/WR(R/W)		When connected to an 8080 MPU, this is active LOW. (R/W) This terminal connects to the 8080 MPU /WR signal. The signals on the data bus are latched at the rising edge of the /WR signal. When connected to a 6800 Series MPU: This is the read/write control signal input terminal. When R/W = " H" : Read. When R/W = " L" : Write.

5	/RD(E)	<p>When connected to an 8080 MPU, this is active LOW. (E) This pin is connected to the /RD signal of the 8080 MPU, and the ST7565P series data bus is in an output status when this signal is “ L” .</p> <p>When connected to a 6800 Series MPU, this is active HIGH.</p> <p>This is the 6800 Series MPU enable clock input terminal.</p>
6	DB0	<p>This is an 8-bit bi-directional data bus that connects to an 8-bit or 16-bit standard MPU data Bus.</p>
7	DB1	
8	DB2	
9	DB3	
10	DB4	
11	DB5	
12	DB6	
13	DB7	
14	VDD	Shared with the MPU power supply terminal VDD. (3.3 V)
15	VSS	This is a 0V terminal connected to the system GND.
16	VOUT	DC/DC voltage converter. Connect a capacitor between this terminal and VSS.
17	CAP5+	DC/DC voltage converter. Connect a capacitor between this terminal and the CAP1- terminal.
18	CAP3+	DC/DC voltage converter. Connect a capacitor between this terminal and the CAP1- terminal.
19	CAP1-	DC/DC voltage converter. Connect a capacitor between this terminal and the CAP1+ terminal.
20	CAP1+	DC/DC voltage converter. Connect a capacitor between this terminal and the CAP1- terminal.
21	CAP2+	DC/DC voltage converter. Connect a capacitor between this terminal and the CAP2- terminal.
22	CAP2-	DC/DC voltage converter. Connect a capacitor between this terminal and the CAP2+ terminal.
23	CAP4+	DC/DC voltage converter. Connect a capacitor between this terminal and the CAP2- terminal.
24	VRS	This is the externally-input VREG power supply for the LCD power supply voltage regulator.
25	V4	<p>This is a multi-level power supply for the liquid crystal drive. The voltage Supply applied is determined by the liquid crystal cell, and is changed through the use of a resistive voltage divided or through changing the impedance using an op. amp. Voltage levels are determined based on Vss, and must</p>
26	V3	
27	V2	

28	V1		maintain the relative magnitudes shown below. $V0 \geq V1 \geq V2 \geq V3 \geq V4 \geq V_{SS}$																														
29	V0		When the power supply turns ON, the internal power supply circuits produce the V1 to V4 voltages shown below. The voltage settings are selected using the LCD bias set command. <table border="1"> <thead> <tr> <th></th> <th>1/65 DUTY</th> <th>1/49 DUTY</th> <th>1/33 DUTY</th> <th>1/55 DUTY</th> <th>1/53 DUTY</th> </tr> </thead> <tbody> <tr> <td>V1</td> <td>$8/9 \cdot V0, 6/7 \cdot V0$</td> <td>$7/8 \cdot V0, 5/6 \cdot V0$</td> <td>$5/6 \cdot V0, 4/5 \cdot V0$</td> <td>$7/8 \cdot V0, 5/6 \cdot V0$</td> <td>$7/8 \cdot V0, 5/6 \cdot V0$</td> </tr> <tr> <td>V2</td> <td>$7/9 \cdot V0, 5/7 \cdot V0$</td> <td>$6/8 \cdot V0, 4/6 \cdot V0$</td> <td>$4/6 \cdot V0, 3/5 \cdot V0$</td> <td>$6/8 \cdot V0, 4/6 \cdot V0$</td> <td>$6/8 \cdot V0, 4/6 \cdot V0$</td> </tr> <tr> <td>V3</td> <td>$2/9 \cdot V0, 2/7 \cdot V0$</td> <td>$2/8 \cdot V0, 2/6 \cdot V0$</td> <td>$2/6 \cdot V0, 2/5 \cdot V0$</td> <td>$2/8 \cdot V0, 2/6 \cdot V0$</td> <td>$2/8 \cdot V0, 2/6 \cdot V0$</td> </tr> <tr> <td>V4</td> <td>$1/9 \cdot V0, 1/7 \cdot V0$</td> <td>$1/8 \cdot V0, 1/6 \cdot V0$</td> <td>$1/6 \cdot V0, 1/5 \cdot V0$</td> <td>$1/8 \cdot V0, 1/6 \cdot V0$</td> <td>$1/8 \cdot V0, 1/6 \cdot V0$</td> </tr> </tbody> </table>		1/65 DUTY	1/49 DUTY	1/33 DUTY	1/55 DUTY	1/53 DUTY	V1	$8/9 \cdot V0, 6/7 \cdot V0$	$7/8 \cdot V0, 5/6 \cdot V0$	$5/6 \cdot V0, 4/5 \cdot V0$	$7/8 \cdot V0, 5/6 \cdot V0$	$7/8 \cdot V0, 5/6 \cdot V0$	V2	$7/9 \cdot V0, 5/7 \cdot V0$	$6/8 \cdot V0, 4/6 \cdot V0$	$4/6 \cdot V0, 3/5 \cdot V0$	$6/8 \cdot V0, 4/6 \cdot V0$	$6/8 \cdot V0, 4/6 \cdot V0$	V3	$2/9 \cdot V0, 2/7 \cdot V0$	$2/8 \cdot V0, 2/6 \cdot V0$	$2/6 \cdot V0, 2/5 \cdot V0$	$2/8 \cdot V0, 2/6 \cdot V0$	$2/8 \cdot V0, 2/6 \cdot V0$	V4	$1/9 \cdot V0, 1/7 \cdot V0$	$1/8 \cdot V0, 1/6 \cdot V0$	$1/6 \cdot V0, 1/5 \cdot V0$	$1/8 \cdot V0, 1/6 \cdot V0$	$1/8 \cdot V0, 1/6 \cdot V0$
	1/65 DUTY	1/49 DUTY	1/33 DUTY	1/55 DUTY	1/53 DUTY																												
V1	$8/9 \cdot V0, 6/7 \cdot V0$	$7/8 \cdot V0, 5/6 \cdot V0$	$5/6 \cdot V0, 4/5 \cdot V0$	$7/8 \cdot V0, 5/6 \cdot V0$	$7/8 \cdot V0, 5/6 \cdot V0$																												
V2	$7/9 \cdot V0, 5/7 \cdot V0$	$6/8 \cdot V0, 4/6 \cdot V0$	$4/6 \cdot V0, 3/5 \cdot V0$	$6/8 \cdot V0, 4/6 \cdot V0$	$6/8 \cdot V0, 4/6 \cdot V0$																												
V3	$2/9 \cdot V0, 2/7 \cdot V0$	$2/8 \cdot V0, 2/6 \cdot V0$	$2/6 \cdot V0, 2/5 \cdot V0$	$2/8 \cdot V0, 2/6 \cdot V0$	$2/8 \cdot V0, 2/6 \cdot V0$																												
V4	$1/9 \cdot V0, 1/7 \cdot V0$	$1/8 \cdot V0, 1/6 \cdot V0$	$1/6 \cdot V0, 1/5 \cdot V0$	$1/8 \cdot V0, 1/6 \cdot V0$	$1/8 \cdot V0, 1/6 \cdot V0$																												
30	VR		Output voltage regulator terminal. Provides the voltage between VDD and V5 through a resistive voltage divider. IRS = " L " : the V5 voltage regulator internal resistors are not used . IRS = " H " : the V5 voltage regulator internal resistors are used .																														
31	C86		This is the MPU interface switch terminal. C86 = " H " : 6800 Series MPU interface. C86 = " L " : 8080 MPU interface.																														
32	P/S		This is the parallel data input/serial data input switch terminal. P/S = " H " : Parallel data input. P/S = " L " : Serial data input. The following applies depending on the P/S status: <table border="1"> <thead> <tr> <th>P/S</th> <th>Data/Command</th> <th>Data</th> <th>Read/Write</th> <th>Serial Clock</th> </tr> </thead> <tbody> <tr> <td>"H"</td> <td>A0</td> <td>D0 to D7</td> <td>\overline{RD}, \overline{WR}</td> <td>X</td> </tr> <tr> <td>"L"</td> <td>A0</td> <td>SI (D7)</td> <td>Write only</td> <td>SCL (D6)</td> </tr> </tbody> </table> When P/S = " L " , D0 to D5 may be " H " , " L " or Open. RD (E) and WR (R/W) are fixed to either " H " or " L " . With serial data input, It is impossible read data from RAM .	P/S	Data/Command	Data	Read/Write	Serial Clock	"H"	A0	D0 to D7	\overline{RD} , \overline{WR}	X	"L"	A0	SI (D7)	Write only	SCL (D6)															
P/S	Data/Command	Data	Read/Write	Serial Clock																													
"H"	A0	D0 to D7	\overline{RD} , \overline{WR}	X																													
"L"	A0	SI (D7)	Write only	SCL (D6)																													
33	/HPM		This is the power control terminal for the power supply circuit for liquid crystal drive. HPM = " H " : Normal mode HPM = " L " : High power mode																														

34	IRS		<p>This terminal selects the resistors for the V5 voltage level adjustment.</p> <p>IRS = “ H” : Use the internal resistors</p> <p>IRS = “ L” : Do not use the internal resistors. The V5 voltage level is regulated by an external resistive voltage divider attached to the VR terminal</p>
----	-----	--	--

8. Contour Drawing & Block Diagram

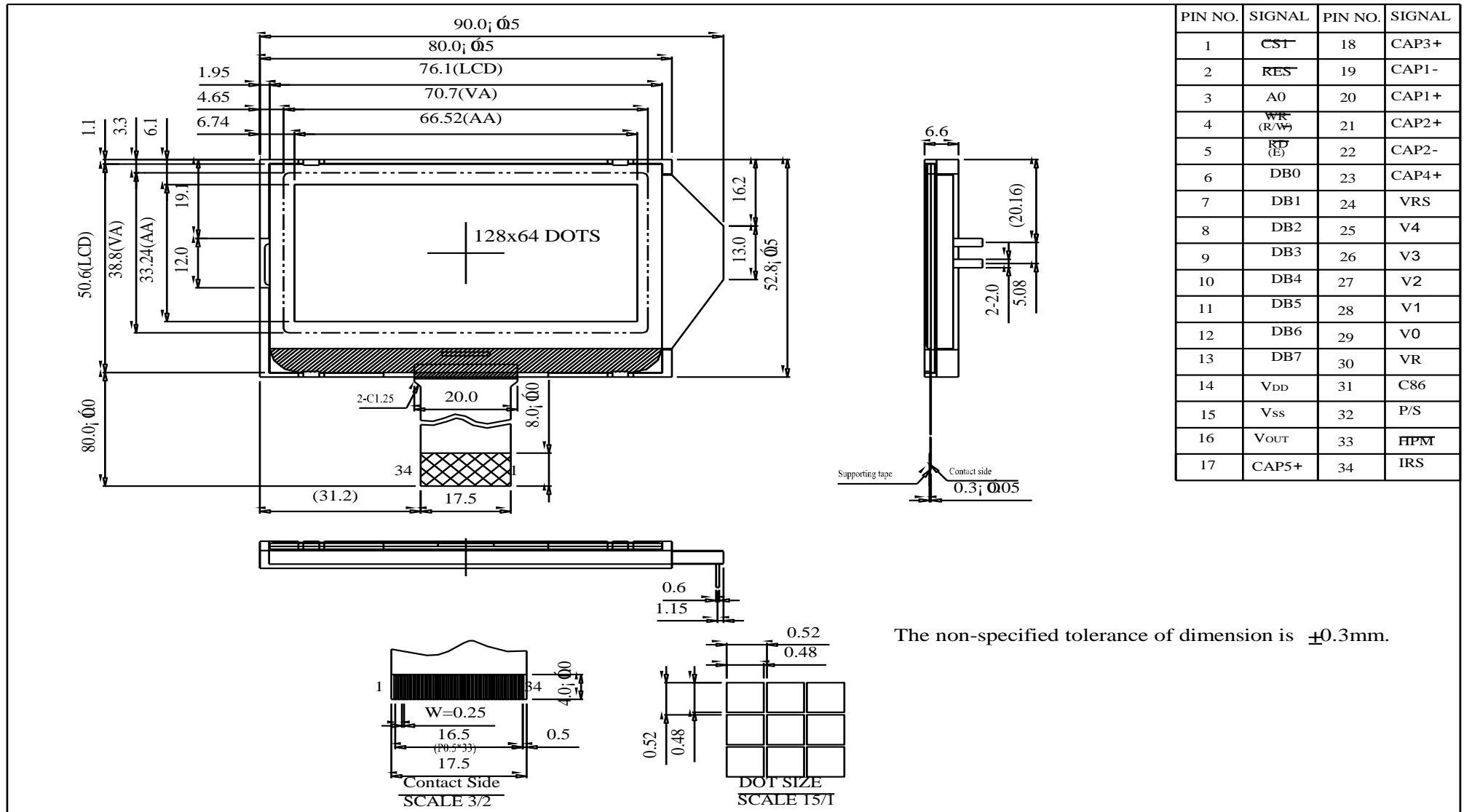

9. Timing Characteristics

Reference to Sitronix [ST7565P.pdf](#)

10. Reliability

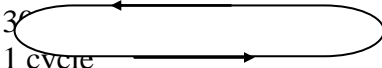
Environmental Test			
Test Item	Content of Test	Test Condition	Note
High Temperature storage	Endurance test applying the high storage temperature for a long time.	80°C 200hrs	2
Low Temperature storage	Endurance test applying the high storage temperature for a long time.	-30°C 200hrs	1,2
High Temperature Operation	Endurance test applying the electric stress (Voltage & Current) and the thermal stress to the element for a long time.	70°C 200hrs	—
Low Temperature Operation	Endurance test applying the electric stress under low temperature for a long time.	-20°C 200hrs	1
High Temperature/ Humidity Operation	The module should be allowed to stand at 60°C,90%RH max For 96hrs under no-load condition excluding the polarizer, Then taking it out and drying it at normal temperature.	60°C,90%RH 96hrs	1,2
Thermal shock resistance	The sample should be allowed stand the following 10 cycles of operation -20°C 25°C 70°C 	-20°C/70°C 10 cycles	—
Vibration test	Endurance test applying the vibration during transportation and using.	Total fixed amplitude : 1.5mm Vibration Frequency : 10~55Hz One cycle 60 seconds to 3 directions of X,Y,Z for Each 15 minutes	3
Static electricity test	Endurance test applying the electric stress to the terminal.	VS=800V,RS=1.5kΩ CS=100pF 1 time	—

Content of Reliability Test (wide temperature, -20°C~70°C)

Note1: No dew condensation to be observed.

Note2: The function test shall be conducted after 4 hours storage at the normal Temperature and humidity after remove from the test chamber.

Note3: Vibration test will be conducted to the product itself without putting it in a container.

11.Backlight Information

Specification

PARAMETER	SYMBOL	MIN	TYP	MAX	UNIT	TEST CONDITION
Supply Current	I _{LED}	14.4	16	25	mA	V= 3.5 V
Supply Voltage	V	3.4	3.5	3.6	V	-
Reverse Voltage	V _R	-	-	5	V	-
Luminous Intensity (Without LCD)	I _V	75	95	-	CD/M ²	I _{LED} = 16 mA
LED Life Time (For Reference only)	-		50K		Hr.	I _{LED} ≤ 16 mA 25°C,50-60%RH, (Note 1)
Color	White					

Note: The LED of B/L is drive by current only ; driving voltage is only for reference

To make driving current in safety area (waste current between minimum and maximum).

Note1: 50K hours is only a estimate for reference.

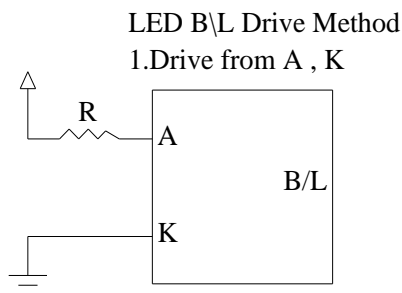

12. Inspection specification

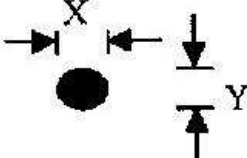
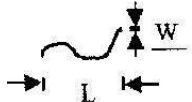
NO	Item	Criterion	AQL											
01	Electrical Testing	1.1 Missing vertical, horizontal segment, segment contrast defect. 1.2 Missing character, dot or icon. 1.3 Display malfunction. 1.4 No function or no display. 1.5 Current consumption exceeds product specifications. 1.6 LCD viewing angle defect. 1.7 Mixed product types. 1.8 Contrast defect.	0.65											
02	Black or white spots on LCD (display only)	2.1 White and black spots on display $\leq 0.25\text{mm}$, no more than three white or black spots present. 2.2 Densely spaced: No more than two spots or lines within 3mm	2.5											
03	LCD black spots, white spots, contamination (non-display)	3.1 Round type : As following drawing $\Phi = (x + y) / 2$  <table border="1" data-bbox="874 1010 1353 1518"> <thead> <tr> <th>SIZE</th> <th>Acceptable QTY</th> </tr> </thead> <tbody> <tr> <td>$\Phi \leq 0.10$</td> <td>Accept no dense</td> </tr> <tr> <td>$0.10 < \Phi \leq 0.20$</td> <td>2</td> </tr> <tr> <td>$0.20 < \Phi \leq 0.25$</td> <td>1</td> </tr> <tr> <td>$0.25 < \Phi$</td> <td>0</td> </tr> </tbody> </table>	SIZE	Acceptable QTY	$\Phi \leq 0.10$	Accept no dense	$0.10 < \Phi \leq 0.20$	2	$0.20 < \Phi \leq 0.25$	1	$0.25 < \Phi$	0	2.5	
		SIZE	Acceptable QTY											
$\Phi \leq 0.10$	Accept no dense													
$0.10 < \Phi \leq 0.20$	2													
$0.20 < \Phi \leq 0.25$	1													
$0.25 < \Phi$	0													
3.2 Line type : (As following drawing)  <table border="1" data-bbox="710 1559 1353 1832"> <thead> <tr> <th>Length</th> <th>Width</th> <th>Acceptable QTY</th> </tr> </thead> <tbody> <tr> <td>---</td> <td>$W \leq 0.02$</td> <td>Accept no dense</td> </tr> <tr> <td>$L \leq 3.0$</td> <td>$0.02 < W \leq 0.03$</td> <td rowspan="2">2</td> </tr> <tr> <td>$L \leq 2.5$</td> <td>$0.03 < W \leq 0.05$</td> </tr> <tr> <td>---</td> <td>$0.05 < W$</td> <td>As round type</td> </tr> </tbody> </table>	Length	Width	Acceptable QTY	---	$W \leq 0.02$	Accept no dense	$L \leq 3.0$	$0.02 < W \leq 0.03$	2	$L \leq 2.5$	$0.03 < W \leq 0.05$	---	$0.05 < W$	As round type
Length	Width	Acceptable QTY												
---	$W \leq 0.02$	Accept no dense												
$L \leq 3.0$	$0.02 < W \leq 0.03$	2												
$L \leq 2.5$	$0.03 < W \leq 0.05$													
---	$0.05 < W$	As round type												

04	Polarizer bubbles	If bubbles are visible, judge using black spot specifications, not easy to find, must check in specify direction.	Size Φ	Acceptable Q TY	2.5
			$\Phi \leq 0.20$	Accept no dense	
			$0.20 < \Phi \leq 0.50$	3	
			$0.50 < \Phi \leq 1.00$	2	
			$1.00 < \Phi$	0	
			Total Q TY	3	

NO	Item	Criterion	AQL
05	Scratches	Follow NO.3 LCD black spots, white spots, contamination	

Symbols Define:

x: Chip length y: Chip width z: Chip thickness
 k: Seal width t: Glass thickness a: LCD side length
 L: Electrode pad length:

6.1 General glass chip :

6.1.1 Chip on panel surface and crack between panels:

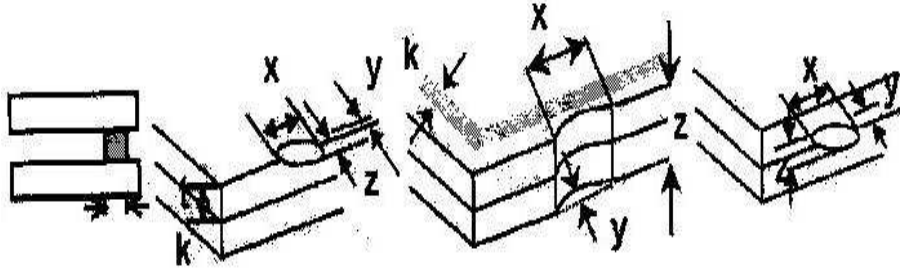

z: Chip thickness	y: Chip width	x: Chip length
$z \leq 1/2t$	Not over viewing area	$x \leq 1/8a$
$1/2t < z \leq 2t$	Not exceed 1/3k	$x \leq 1/8a$

⊙ If there are 2 or more chips, x is total length of each chip.

6.1.2 Corner crack:

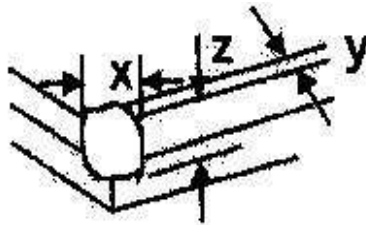

z: Chip thickness	y: Chip width	x: Chip length
$z \leq 1/2t$	Not over viewing area	$x \leq 1/8a$
$1/2t < z \leq 2t$	Not exceed 1/3k	$x \leq 1/8a$

⊙ If there are 2 or more chips, x is the total length of each chip.

06

Chipped glass

2.5

NO	Item	Criterion	AQL
----	------	-----------	-----

Symbols :

x: Chip length y: Chip width z: Chip thickness
 k: Seal width t: Glass thickness a: LCD side length
 L: Electrode pad length

6.2 Protrusion over terminal :

6.2.1 Chip on electrode pad :

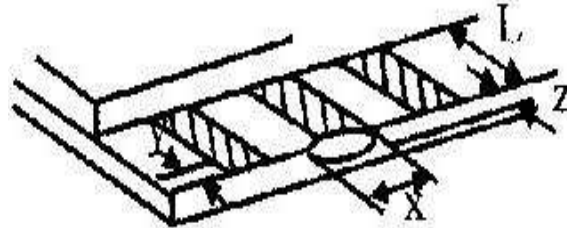

y: Chip width	x: Chip length	z: Chip thickness
$y \leq 0.5\text{mm}$	$x \leq 1/8a$	$0 < z \leq t$

6.2.2 Non-conductive portion:

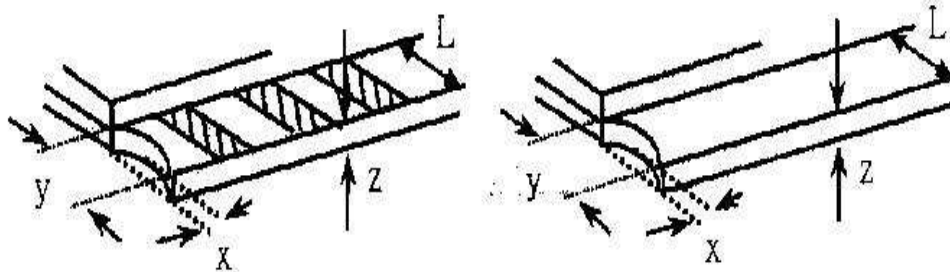

y: Chip width	x: Chip length	z: Chip thickness
$y \leq L$	$x \leq 1/8a$	$0 < z \leq t$

- ⊙ If the chipped area touches the ITO terminal, over 2/3 of the ITO must remain and be inspected according to electrode terminal specifications.
- ⊙ If the product will be heat sealed by the customer, the alignment mark not be damaged.

6.2.3 Substrate protuberance and internal crack.

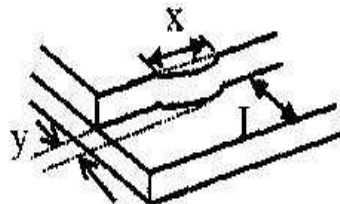

y: width	x: length
$y \leq 1/3L$	$x \leq a$

06

Glass crack

2.5

NO	Item	Criterion	AQL
07	Cracked glass	The LCD with extensive crack is not acceptable.	2.5
08	Backlight elements	<p>8.1 Illumination source flickers when lit.</p> <p>8.2 Spots or scratched that appear when lit must be judged. Using LCD spot, lines and contamination standards.</p> <p>8.3 Backlight doesn't light or color wrong.</p>	<p>0.65</p> <p>2.5</p> <p>0.65</p>
09	Bezel	<p>9.1 Bezel may not have rust, be deformed or have fingerprints, stains or other contamination.</p> <p>9.2 Bezel must comply with job specifications.</p>	<p>2.5</p> <p>0.65</p>
10	PCB、COB	<p>10.1 COB seal may not have pinholes larger than 0.2mm or contamination.</p> <p>10.2 COB seal surface may not have pinholes through to the IC.</p> <p>10.3 The height of the COB should not exceed the height indicated in the assembly diagram.</p> <p>10.4 There may not be more than 2mm of sealant outside the seal area on the PCB. And there should be no more than three places.</p> <p>10.5 No oxidation or contamination PCB terminals.</p> <p>10.6 Parts on PCB must be the same as on the production characteristic chart. There should be no wrong parts, missing parts or excess parts.</p> <p>10.7 The jumper on the PCB should conform to the product characteristic chart.</p> <p>10.8 If solder gets on bezel tab pads, LED pad, zebra pad or screw hold pad, make sure it is smoothed down.</p> <p>10.9 The Scraping testing standard for Copper Coating of PCB</p>	<p>2.5</p> <p>2.5</p> <p>0.65</p> <p>2.5</p> <p>2.5</p> <p>0.65</p> <p>2.5</p> <p>2.5</p> <p>2.5</p>

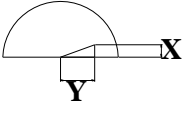
		 $X * Y \leq 2\text{mm}^2$	
11	Soldering	<p>11.1 No un-melted solder paste may be present on the PCB.</p> <p>11.2 No cold solder joints, missing solder connections, oxidation or icicle.</p> <p>11.3 No residue or solder balls on PCB.</p> <p>11.4 No short circuits in components on PCB.</p>	<p>2.5</p> <p>2.5</p> <p>2.5</p> <p>0.65</p>

NO	Item	Criterion	AQL
12	General appearance	12.1 No oxidation, contamination, curves or, bends on interface Pin (OLB) of TCP.	2.5
		12.2 No cracks on interface pin (OLB) of TCP.	0.65
		12.3 No contamination, solder residue or solder balls on product.	2.5
		12.4 The IC on the TCP may not be damaged, circuits.	2.5
		12.5 The uppermost edge of the protective strip on the interface pin must be present or look as if it cause the interface pin to sever.	2.5
		12.6 The residual rosin or tin oil of soldering (component or chip component) is not burned into brown or black color.	0.65
		12.7 Sealant on top of the ITO circuit has not hardened.	0.65
		12.8 Pin type must match type in specification sheet.	0.65
		12.9 LCD pin loose or missing pins.	0.65
		12.10 Product packaging must the same as specified on packaging specification sheet.	0.65
		12.11 Product dimension and structure must conform to product specification sheet.	0.65

--	--	--	--

13. Material List of Components for RoHs

1. The factory hereby declares that all of or part of products (with the mark “#”in code), including, but not limited to, the LCM, accessories or packages, manufactured and/or delivered to your company (including your subsidiaries and affiliated company) directly or indirectly by our company (including our subsidiaries or affiliated companies) do not intentionally contain any of the substances listed in all applicable EU directives and regulations, including the following substances.

Exhibit A : The Harmful Material List

Material	(Cd)	(Pb)	(Hg)	(Cr6+)	PBBs	PBDEs
Limited Value	100 ppm	1000 ppm	1000 ppm	1000 ppm	1000 ppm	1000 ppm
Above limited value is set up according to RoHS.						

2. Process for RoHS requirement :

(1) Use the Sn/Ag/Cu soldering surface ; the surface of Pb-free solder is rougher than we used before.

(2) Heat-resistance temp. :

Reflow : 250°C,30 seconds Max. ;

Connector soldering wave or hand soldering : 320°C, 10 seconds max.

(3) Temp. curve of reflow, max. Temp. : 235±5°C ;

Recommended customer’s soldering temp. of connector : 280°C, 3 seconds.



SOG12806432-BTN-BWLW

Sales signature : _____

Customer Signature : _____

Date : / / _____