

# ROCKER SWITCH

## Features

- Power switch conforms to safety standards for electrical equipment.
- Compact with a good space factor.
- Snap-in type for easy mounting.
- The color can be changed to correspond to the set design.
- Lamps for 125V and for 250V respectively for illuminating type.



## Applications

- Information and office equipment such as personal computers, word processors, facsimiles, monitors, etc.

## Specifications

Item	Standard
Rating	12A 125VAC / 250VAC
Insulation Resistance	100M $\Omega$ min (DC 500V)
Dielectric Strength	AC 1500V (50/60Hz for 1 minute)
Contact Resistance	50m $\Omega$ max. (initial)
Electrically Life	10,000 cycle
Operating Force	500 $\pm$ 200 gf

## Product Selection

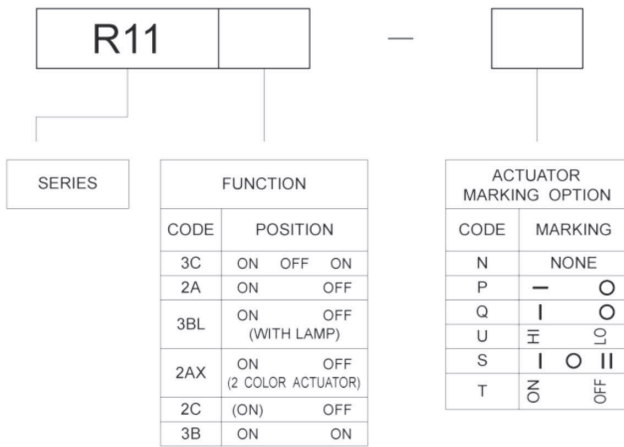

## Panel Hole Size

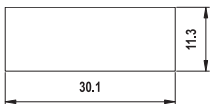

**HIGHLY**

F3

Design, specifications are subject to change without notice.

# ROCKER SWITCH

## Dimensions

Unit: mm

Item

Operating Characteristics

Dimensions

R11-3C

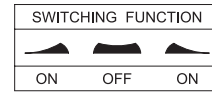
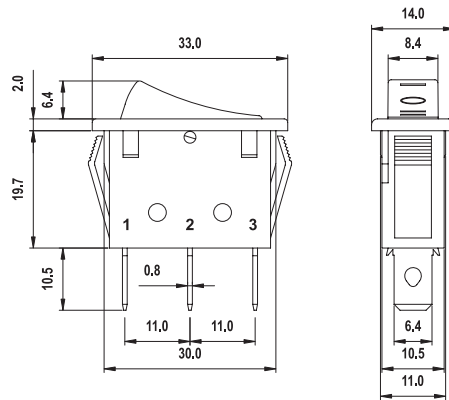

R11-3BL

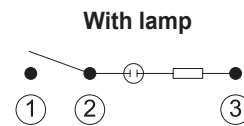
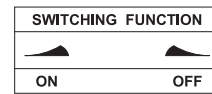
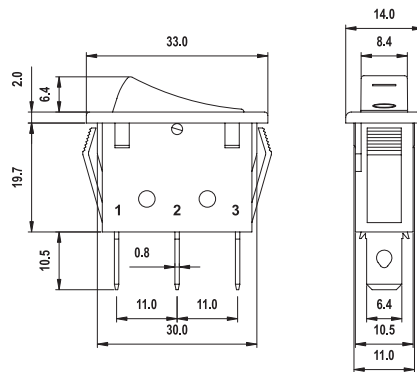

R11-2A

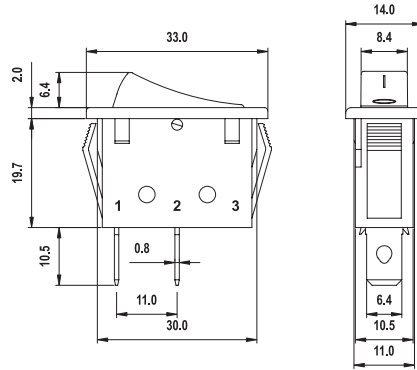

R11-2AX

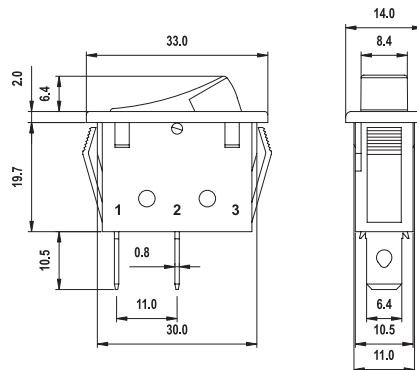

**HIGHLY**

F4

Design, specifications are subject to change without notice.