

» Features

- Miniature & low cost switch with full surface illumination by LED.
- For PC Board Terminals are all IC pitched (multiple of 2.54mm).
- Many LED lights are available.
- Various symbols can be engraved on the cap.
- Any customization for cap & symbol is welcomed.



» Applications

- Operating switches in all types of electronic equipment such as audio apparatus, office equipment, communications apparatus, TV sets, VCRs, etc.

» Specifications

SERIES	TP617	TP627	TP637	TP647
Rating	50mA 48VDC	10mA 12VDC	50mA 48VDC	50mA 12VDC
Insulation Resistance	100MΩ Min (at 500 VDC)	100MΩ Min (at 500 VDC)	100MΩ Min (at 500 VDC)	100MΩ Min (at 500 VDC)
Dielectric Strength	AC 250V (50/60 Hz for 1 minute)	AC 250V (50/60 Hz for 1 minute)	AC 250V (50/60 Hz for 1 minute)	AC 250V (50/60 Hz for 1 minute)
Contact Resistance	100mΩ Max. (Initial)	500mΩ Max. (Initial)	100mΩ Max. (Initial)	20mΩ Max. (Initial)
Electrically Life	300,000 Cycles Min	100,000 Cycles Min	300,000 Cycles Min	100,000 Cycles Min
Ambient Temperature	-20°C~ +70°C	-20°C~ +70°C	-20°C~ +70°C	-20°C~ +70°C
Total Trovel	0.25 ± 0.1mm	1.0 ± 0.2mm	0.6 ± 0.2mm	1.0mm Min
Operating Force	160 ± 50gf	100 ± 40gf	250 ± 50gf	200gf Min
	100 ± 30gf			
	300 ± 100gf			

» Product selection

TP

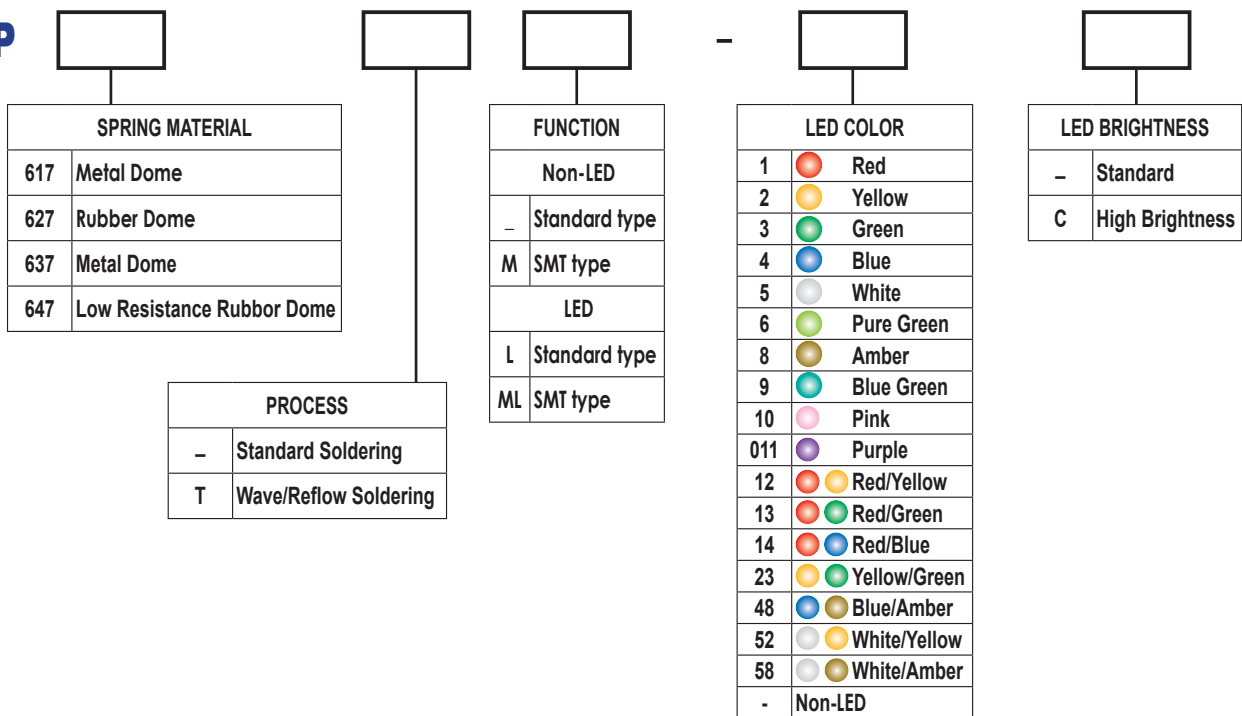

» LED Specifications

Color	VR	IF	Recommended Operating Current	VF	
				Nom	Max
Red	DC 5V	20mA	20mA	1.7V	2.4V
Green	DC 5V	20mA	20mA	1.9V	2.4V
Yellow	DC 5V	20mA	20mA	1.9V	2.4V
Blue	DC 5V	20mA	20mA	3.0V	3.6V
White	DC 5V	20mA	20mA	3.0V	3.6V

For the specification about the other LEDs, please contact with sales department

» Operating characteristics

Unit: mm

Dimensions

P.C.B Layout

TP617 TP637 (Metal) TP627 (Rubber)

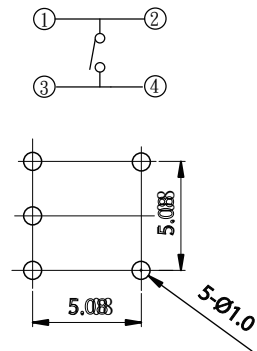
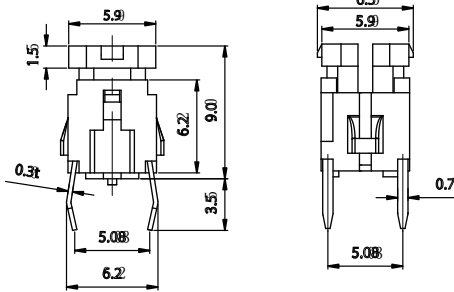
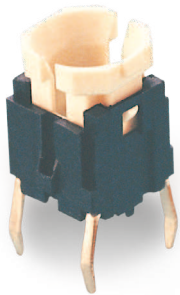

TP617ML TP637ML (Metal) TP627ML (Rubber)

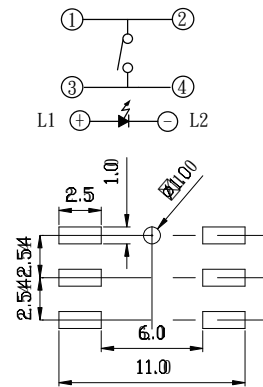
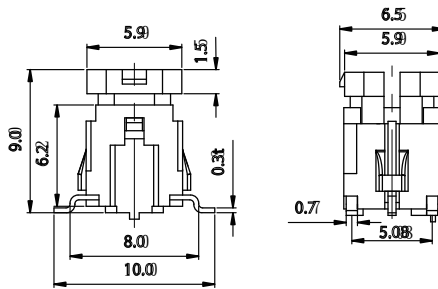
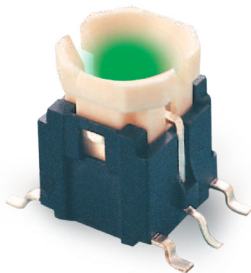

TP647TL (Low Resistance Rubber Dome)

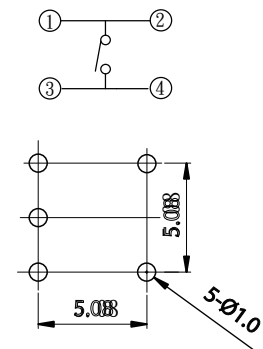
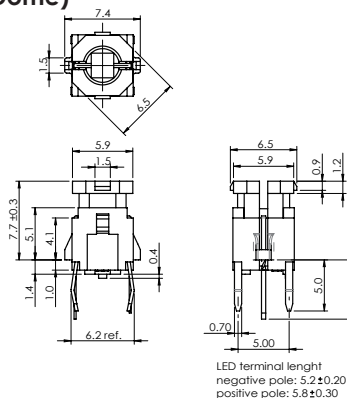
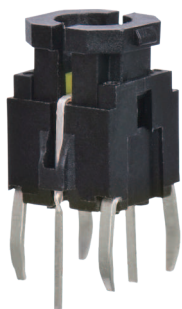

LED terminal length
negative pole: 5.2±0.20
positive pole: 5.8±0.30