

Control Relay Contacts Remotely

The **RC-2A** Remote Controller provides remote relay operation from any standard Touch Tone telephone.

The controller is designed to be installed either locally or remotely. For local installations the **RC-2A** can be installed in parallel on any analog communications path, such as analog C.O. lines or analog PABX/KSU stations and will passively monitor for Touch Tone commands.

For off-premise applications, the **RC-2A** will answer analog C.O. lines or PABX/KSU stations after a selectable ring delay. A field programmable access code can be programmed to prevent unauthorized usage, and then the **RC-2A** can be activated to allow remote relay operation.



Note: For doorstrike control with Viking **W-Series** Doorboxes, see Viking model **SRC-1** (DOD#175) or **C-1000B** (DOD# 168).

Features

- Programmable access code
- Normally open or normally closed relay
- Selectable relay closure times
- Selectable ring delay (1, 2, 6, or 15)
- Universal 12-24V AC/DC power input
- **Easy installation with screw terminals and dip switch programming**
- Automatic disconnect or return to secure mode after 60 seconds
- Power multiple units from one adapter
- One year warranty

www.vikingelectronics.com
Information: (715) 386-8861

Applications

Remote Control of:

- High security building entry
- Heating/cooling equipment
- Pumps and fans
- Security systems
- Gates
- Lighting
- PABX/KSU reset

Specifications

Power: 120VAC / 12VDC 500mA UL listed adapter provided, alternative power input: 12-24V AC/DC 200mA minimum

Dimensions: 133mm x 89mm x 44mm (5.25" x 3.5" x 1.75")

Shipping Weight: .9 kg (2 lbs)

Environmental: -40°C to 70°C (-40°F to 160°F) with 5% to 95% non-condensing humidity

Relay Contact Ratings: 5A @ 30VDC / 250VAC

Connections: (1) 8 position screw terminal block

Installation

IMPORTANT: Electronic devices are susceptible to lightning and power station electrical surges from both the AC outlet and the telephone line. It is recommended that a surge protector be installed to protect against such surges.

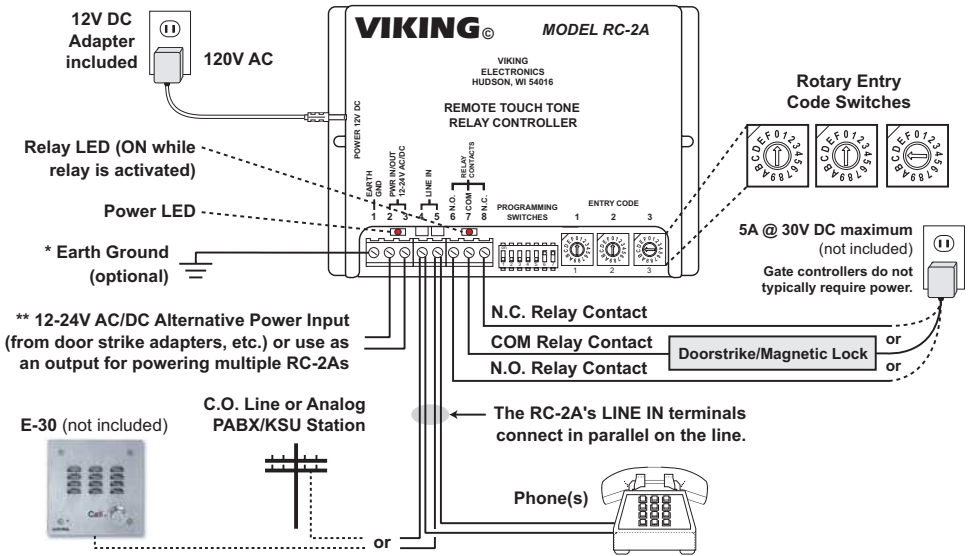

**** Note:** The 12V DC adapter (model PS-2) supplied with the unit can power up to (4) RC-2A's and a Viking model PS-1A, 13.8V AC adapter, can be used to power up to (8) RC-2A's. A PS-1A (13.8V AC adapter) may be purchased separately. Go to www.vikingelectronics.com and click on "Spare Parts".

Modes

IMPORTANT: Please read the following sections to determine which RC-2A mode works best for your application.

A. Choosing a Mode

The RC-2A has two operational modes built in, called the Legacy and Alternative modes. The Legacy mode is the standard mode of operation that has existed in all previous versions of the RC-2A. The Alternative mode is a second mode of operation that increases the RC-2A's flexibility in some applications. The operational mode you should use depends on the exact application for the RC-2A. Here are some general guidelines, but in some applications, the opposite mode may be needed (also see section B-C on page 3 describing the advantages and disadvantages of each operational mode):

Application Description	Recommended Mode	Additional Programming
* Use with a Viking W-1000, W-2000A, or W-3000 handsfree doorbox.	Legacy Mode (traditional software)	Set one code switch to D and set DIP switch 5 to OFF .
Use with a Viking E-30 or 1600A Series hands-free phone.	Alternative Mode (new software)	Set at least one code switch to B , set DIP switch 5 to ON and DIP switch 7 to OFF .
On a dedicated telephone line or PBX extension (no other phones on the same line or extension).	Legacy Mode (traditional software)	Set one code switch to C , set DIP switch 2 to ON and DIP switch 5 to OFF .
Wired across a telephone line in a residential application (sharing the line with other phones), to control lights, door or gate.	Legacy Mode (traditional software)	Set DIP switch 5 to OFF and do not set any code switches to C or D .

* **Caution:** For increased security, Viking recommends using a Viking model SRC-1 or C-1000B Controller with W-Series Doorboxes.

If you will be connecting the **RC-2A** to a telephone line or PABX extension (regardless of the mode you will be using), the **RC-2A** is always monitoring the telephone line or PBX extension for the correct string of Touch Tones dialed. If the correct string is detected, the **RC-2A** will operate the relay. For example, if you chose the Alternative mode, programmed a single digit relay command of "9" and installed the **RC-2A** onto a telephone line or PABX extension that is shared with other telephones, there could be a problem. As the other phones are making outgoing phone calls, if they dial a phone number that includes the digit "9", the **RC-2A** will operate it's relay. In these applications, you must either use the Legacy mode and set a security access code (no rotary entry code switches set to **D**), or use the Alternative mode and set at least one digit of the relay activation command to be either a "*" or "#".

B. Legacy Mode

1. Advantages

- There are "latch" and "unlatch" relay commands (10 and 19).
- There is a Touch Tone hang up command (8 or 18).
- A wider range of ring delay selections for remote access (1, 2, 6, or 15 rings).

2. Disadvantages

- When a security access code has been programmed (no code switches set to **D**), the complete digit string to operate the relay is relatively long (6 digits total).
- The relay activation commands are fixed in software (not programmable).
- Limited "timed" relay activations available (5 seconds is the longest available).

C. Alternative Mode

1. Advantages

- Shorter length relay activation commands (can be 1, 2, or 3 digits in length).
- Wider range of timed relay activations available (up to 10 minutes maximum).
- You can program the digits dialed to activate the relay.

2. Disadvantages

- There are no "latch/unlatch" relay commands.
- There is no Touch Tone hang up command.
- Fewer ring delay selections for remote access (2 or 15 rings only).

Legacy Programming Mode

Important: The **RC-2A** ships by default in the Legacy Programming mode (DIP switch 5 **OFF**). Optional programming is also available (see **Alternative Programming Mode**). The alternative programming mode dramatically changes the programming and operation of the **RC-2A**. Use only the programming features described in the respective sections for the programming mode you choose.

A. Security Access Code

Note: A security access code should be used, when the **RC-2A** is used on a line with other equipment that may dial.

1. Setting the Security Access Code

The **RC-2A** contains (3) rotary access/entry code switches (see diagram right). Using a small flat blade screwdriver, rotate the arrow on each switch to the desired access code setting. The code may be any digit **0-9** or "**C**" (# on a Touch Tone pad). **Note:** For extreme security applications, a special telephone with a 4 x 4 keypad may be used (**DOD# 855**).

2. Disabling the Security Access Code

If any rotary entry code switch is set to position "**D**" the security access code is disabled. In this case, any call to the **RC-2A** will have immediate access to activation codes (see page 5, **C. Relay Activation Codes**). **Note:** When the security access code is disabled, the setting of DIP switch 3 has no effect (unlimited closures allowed).

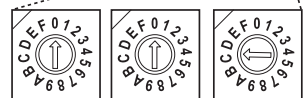
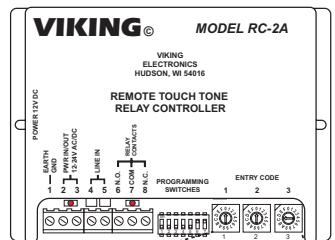

Rotary Access/Entry Code Switches

B. DIP Switch Settings

DIP switches 1-7 may be used to change the operation of the **RC-2A** (see below).

Switch	Position	Description
1	OFF	Latch commands (10 & 19) enabled (factory default)
1	ON	Latch commands are disabled
2	OFF	Ring delay = 15 (no rotary switches set to C, factory default)
2	OFF	Ring delay = 2 (any rotary switch set to C)
2	ON	Ring delay = 6 (no rotary switches set to C)
2	ON	Ring delay = 1 (any rotary switch set to C)
3	OFF	Unlimited number of closures during access time (factory default)
3	ON	One closure per correct access code during access time (no rotary switches set to D)
4	OFF	(Not used in Legacy Programming Mode)
4	ON	(Not used in Legacy Programming Mode)
5	OFF	Legacy Programming Mode (factory default)
5	ON	Alternative Programming Mode
6	OFF	Acknowledgement tones OFF
6	ON	Acknowledgement tones ON (factory default)
7	OFF	Auto-answer OFF (factory default)
7	ON	Auto-answer ON

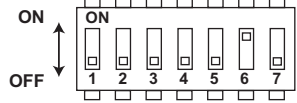
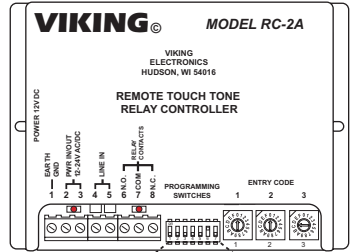

Note: DIP switches are shown in factory default settings.

Switch 1: Latch Commands

If this DIP switch is in the **ON** position, the relay will not be able to be latched (maintained) and command codes 10, 19 and 1# will be ignored.

Switch 2: Ring Delay

The ring delay is the number of incoming rings before the **RC-2A** automatically answers the line. The **RC-2A** answers on the fifteenth ring by default. This can be changed to the first, second or sixth ring by following the instructions above for DIP switch **2** and rotary switch positions.

Switch 3: Closure Limitations

If this DIP switch is placed in the **ON** position, only one closure will be allowed during the access.

Switch 4: Relay Activation Times

This DIP switch is only used in the "Alternative Programming Mode" and has no function in the "Legacy Mode".

Switch 5: Selecting Modes

If this DIP switch is in the **OFF** position, the **RC-2A** is in the "Legacy Programming Mode". In the **ON** position, the **RC-2A** is in the "Alternative Programming Mode".

Switch 6: Relay Acknowledgement Tones

With DIP switch 6 in the **OFF** position, acknowledgement tones (beeps for relay confirmation, etc.) are turned off. With DIP switch 6 in the **ON** position, acknowledgement tones are on.

Switch 7: Automatic Answer

With DIP switch 7 in the **OFF** position, the automatic phone line answering feature is turned off. With DIP switch 7 in the **ON** position, the automatic phone line answering feature is turned on. See DIP switch 2 and rotary switch positions for ring delay (total number of incoming rings before the unit automatically answers the line).

C. Relay Activation Codes

These activation codes are pre-programmed and cannot be changed except when using the **Alternative Programming** mode.

Touch Tone/s	Enter
To energize relay (two beeps)	10
To de-energize relay (one beep)	19
To energize relay momentarily (.5 seconds) (one beep)	13
To energize relay while 4 is pressed and for 1 second after (one beep)	14
To energize relay as long as 5 is pressed (.5 seconds minimum) (one beep)	15
To energize relay while 6 is pressed, and 5 seconds after (one beep)	16
To interrogate the relay status (two beeps - energized, one beep - de-energized)	1#
To release the phone line / return to secure mode (three beeps)	18 or 8

Alternative Programming Mode

Important: In the "Alternative Programming Mode" (DIP switch 5 **ON**), programming and operation are changed dramatically. Please use the following programming sections only when programming in the "Alternative Programming Mode". All "Legacy" Programming and Operation become un-usable and you may **ONLY** program and operate the **RC-2A** using the information provided in the following sections.

A. Security

In the "Alternative Programming Mode" (DIP switch 5 **ON**), access to the **RC-2A** is immediate and it becomes possible to program a one, two or three digit relay activation code. No security access code is programmable or required to gain access.

Rotary Switch	Touch Tone
F	Ignore
C	#
B	*
0...9	0...9

B. Entry Code Switches

The entry code switches set the relay activation code. In addition to the rotary switch positions shown in the chart, this code can also make use of positions D and E, as long as the user is aware that **D** and **E** can only be entered using a special 4x4 keypad. **Note:** For more information on using the **RC-2A** with a special 4x4 keypad, retrieve **DOD# 855**.

1. Single Digit Relay Activation Code

To program a single digit relay activation code, set any two of the three code switches to **F**. **Example: FF3** (shown right).



2. Two-Digit Relay Activation Code

To program a two-digit relay activation code, set any one of the code switches to **F**. The other two switch settings comprise the relay activation code. **Example: F47** (shown right).



3. Special Character Relay Activation Code

To program the relay activation code to be * or #, set all three code switches to **F** (shown right). In this case, either a * or # will activate the relay.



4. Ring Delay

The ring delay is the number of incoming rings before the **RC-2A** automatically answers the line. To program the ring delay to 2 instead of the normal 15, set at least one of the code switches to **B** or **C** (shown right). **Example: FFB = "*" as the activation code and 2 as the ring delay.**



C. DIP Switch Settings

DIP switches 1-4 provide 16 different relay activation times according to the following table:

Switch 1	Switch 2	Switch 3	Switch 4	Relay Activation Time
OFF	OFF	OFF	OFF	1/2 second
OFF	OFF	OFF	ON	1 second
OFF	OFF	ON	OFF	2 seconds
OFF	OFF	ON	ON	3 seconds
OFF	ON	OFF	OFF	4 seconds
OFF	ON	OFF	ON	5 seconds
OFF	ON	ON	OFF	6 seconds
OFF	ON	ON	ON	7 seconds
ON	OFF	OFF	OFF	8 seconds
ON	OFF	OFF	ON	9 seconds
ON	OFF	ON	OFF	10 seconds
ON	OFF	ON	ON	30 seconds
ON	ON	OFF	OFF	45 seconds
ON	ON	OFF	ON	1 minute
ON	ON	ON	OFF	5 minutes
ON	ON	ON	ON	10 minutes

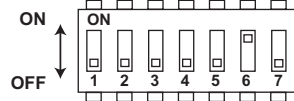
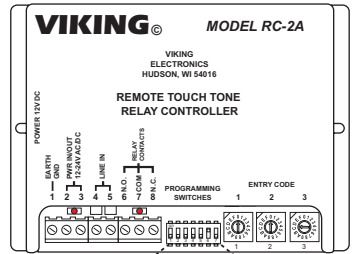

Note: DIP switches are shown in factory default settings.

Switch	Position	Description
5	OFF	Legacy Programming Mode (factory default)
5	ON	Alternative Programming Mode
6	OFF	Acknowledgement tones OFF
6	ON	Acknowledgement tones ON (factory default)
7	OFF	Auto-answer OFF (factory default)
7	ON	Auto-answer ON

Operation

A. Legacy Mode

If the **RC-2A** is programmed to answer a ringing line (DIP switch 7 ON), it will answer after the selected ring delay. A single acknowledgement tone will be heard, signaling the user that the **RC-2A** has answered the line. If a security access code has been programmed (no code switches set to **D**), a touch-tone "*" plus the security access code may be entered at this time and a second acknowledgement tone will be heard. After this acknowledgement tone, the built in 2 digit relay commands can be dialed (see page 5, **C. Relay Activation Codes**). If "*" plus an incorrect security access code is entered, the **RC-2A** will immediately disconnect (hang-up). To prevent unauthorized use, if a user dials "*" plus an incorrect security access code on 5 consecutive incoming calls, the unit will disconnect and not answer the line for 60 minutes.

If the **RC-2A** is not programmed to answer the line (DIP switch 7 OFF), it can passively monitor a communication path for the proper access and/or activation code.

The **RC-2A** provides a relay activation (opening or closing a relay contact) remotely via DTMF Touch Tone input over a standard analog C.O. line or PABX/KSU station. When the correct relay activation code is entered, the **RC-2A** activates its relay contacts on the terminal strip followed by an acknowledgement tone.

1. Accessing the RC-2A Remotely

Step 1.	Set DIP switch 7 to ON and call the RC-2A using a Touch Tone phone.
Step 2.	When the RC-2A answers, a single beep (acknowledgement tone) will be heard.
Step 3.	If the security access code has been disabled (one or more code switches set to D), go to step 4. If a security access code has been set (no code switches set to D), enter "*" followed by your 3 digit security access code (see page 3, A. Security Access Code).
Step 4.	Enter a two digit relay activation code (see page 5, C. Relay Activation Codes). A single or double beep (acknowledgement tone) should be heard.
Step 5.	Enter "8" or "18" before hanging up to force the RC-2A to release the line. Alternatively, the unit will disconnect if no Touch Tones are detected for 60 seconds.
Step 6.	Set DIP switch 7 to the desired position.

2. Accessing the RC-2A Locally

Step 1.	Establish voice connection with the RC-2A by accessing the doorbox or dedicated line.
Step 2.	If the security access code has been disabled (one or more code switches set to D), go to step 3. If a security access code has been set (no code switches set to D), enter "*" followed by your 3 digit security access code (see page 3, A. Security Access Code).
Step 3.	Enter a two digit relay activation code (see page 5, C. Relay Activation Codes). A single or double beep (acknowledgement tone) should be heard.
Step 4.	If a security code has been set (no code switches set to D), enter "8" or "18" before hanging up to place the RC-2A back into secure mode. Alternatively, the unit will automatically return to the secure mode if no Touch Tones are detected for 60 seconds.

B. Alternative Mode

If the **RC-2A** is programmed to answer a ringing line (DIP switch 7 ON), it will do so after the selected ring delay. A single or double acknowledgement tone will be heard, signaling the user that the **RC-2A** has answered the line. After this acknowledgement tone, the one, two or three digit relay activation code can be dialed and a second acknowledgement tone will be heard. The relay activation code is programmed by the setting of the code switches (see page 5, **B. Entry Code Switches**). If the **RC-2A** is not programmed to answer the line (DIP switch 7 OFF), it can passively monitor a communication path for the proper activation code.

The **RC-2A** provides a relay activation (opening or closing a relay contact) remotely via DTMF Touch Tone input over a standard analog C.O. line or PBX/KSU station. When the correct relay activation code is entered, the **RC-2A** provides a single beep as an acknowledgement tone and activates its relay contacts on the terminal strip.

Only "timed" relay activation is possible in the Alternative mode. When the relay activation code is dialed, the timing of the relay contacts depends on the setting of DIP switches 1-4 (see page 6, **C. DIP Switch Settings**). If the **RC-2A** is accessed remotely and there is a relay activation already in progress, the **RC-2A** indicates this by producing two beeps instead of a single beep when it answers. At this point, the user may allow the existing relay activation to continue or start the relay activation over again by entering the relay activation code.

1. Accessing the RC-2A Remotely

Step 1.	Set DIP switch 7 to ON and call the RC-2A using a Touch Tone phone.
Step 2.	When the RC-2A answers, a single or double beep (acknowledgement tone) will be heard.
Step 3.	Enter the one, two or three digit relay activation code (see page 5, B. Entry Code Switches). A single beep (acknowledgement tone) should be heard.
Step 4.	The unit will disconnect when no Touch Tones are detected for 60 seconds.
Step 5.	Set DIP switch 7 to the desired position.

2. Accessing the RC-2A Locally

Step 1.	Establish voice connection with the RC-2A by accessing the doorbox or dedicated line.
Step 2.	Enter the one, two or three digit relay activation code (see page 5, B. Entry Code Switches). A single beep (acknowledgement tone) should be heard.

Related Products

Securely Operate a Doorstrike and Provide Keyless Entry



Model SRC-1 (DOD# 176)

The **SRC-1** enables a standard touch tone phone to securely operate a set of timed relay contacts to control a doorstrike or gate controller at a remote location. The **SRC-1** is fully user programmable and uses non-volatile memory. The **SRC-1** eliminates the possibility of dialing the activation code through the entry phone using a hand held touch tone dialer.

The **SRC-1** features a switchable 32V talk battery to allow use with any of Viking's entry phones (E Series), doorboxes (W Series) or hot-line/panel phones (K Series).

The **SRC-1** is installed between the entry phone and the secure phone, and will reject touch tones from the entry phone and only operate the relay if the correct activation code (user programmable) is given from the secure phone.

The **SRC-1** also provides up to 32 keyless entry codes to operate the relay from the entry phone with 1 to 6 digits. This feature can be disabled in programming for increased security.

Warranty

IF YOU HAVE A PROBLEM WITH A VIKING PRODUCT, CONTACT: VIKING TECHNICAL SUPPORT AT (715) 386-8666

Our Technical Support Department is available for assistance Monday 8am - 4pm and Tuesday through Friday 8am - 5pm central time. So that we can give you better service, before you call please:

1. Know the model number, the serial number and what software version you have (see serial label).
2. Have your Technical Practice in front of you.
3. It is best if you are on site.

RETURNING PRODUCT FOR REPAIR

The following procedure is for equipment that needs repair:

1. Customer must contact Viking's Technical Support Department at 715-386-8666 to obtain a Return Authorization (RA) number. The customer MUST have a complete description of the problem, with all pertinent information regarding the defect, such as options set, conditions, symptoms, methods to duplicate problem, frequency of failure, etc.
2. Packing: Return equipment in original box or in proper packing so that damage will not occur while in transit. Static sensitive equipment such as a circuit board should be in an anti-static bag, sandwiched between foam and individually boxed. All equipment should be wrapped to avoid packing material lodging in or sticking to the equipment. Include ALL parts of the equipment. C.O.D. or freight collect shipments cannot be accepted. Ship cartons prepaid to: **Viking Electronics, 1531 Industrial Street, Hudson, WI 54016**
3. Return shipping address: Be sure to include your return shipping address inside the box. We cannot ship to a PO Box.
4. RA number on carton: In large printing, write the R.A. number on the outside of each carton being returned.

RETURNING PRODUCT FOR EXCHANGE

The following procedure is for equipment that has failed out-of-box (within 10 days of purchase):

1. Customer must contact Viking's Technical Support at 715-386-8666 to determine possible causes for the problem. The customer MUST be able to step through recommended tests for diagnosis.
2. If the Technical Support Product Specialist determines that the equipment is defective based on the customer's input and troubleshooting, a Return Authorization (R.A.) number will be issued. This number is valid for fourteen (14) calendar days from the date of issue.
3. After obtaining the R.A. number, return the approved equipment to your distributor, referencing the R.A. number. Your distributor will then replace the Viking product using the same R.A. number.
4. The distributor will NOT exchange this product without first obtaining the R.A. number from you. If you haven't followed the steps listed in 1, 2 and 3, be aware that you will have to pay a restocking charge.

LIMITED WARRANTY

Viking warrants its products to be free from defects in the workmanship or materials, under normal use and service, for a period of one year from the date of purchase from any authorized Viking distributor or 18 months from the date manufactured, whichever ever is greater. If at any time during the warranty period, the product is deemed defective or malfunctions, return the product to Viking Electronics, Inc., 1531 Industrial Street, Hudson, WI., 54016. Customer must contact Viking's Technical Support Department at 715-386-8666 to obtain a Return Authorization (R.A.) number.

This warranty does not cover any damage to the product due to lightning, over voltage, under voltage, accident, misuse, abuse, negligence or any damage caused by use of the product by the purchaser or others. This warranty does not cover non-EWP products that have been exposed to wet or corrosive environments.

NO OTHER WARRANTIES. VIKING MAKES NO WARRANTIES RELATING TO ITS PRODUCTS OTHER THAN AS DESCRIBED ABOVE AND DISCLAIMS ANY EXPRESS OR IMPLIED WARRANTIES OR MERCHANTABILITY OR FITNESS FOR ANY PARTICULAR PURPOSE.

EXCLUSION OF CONSEQUENTIAL DAMAGES. VIKING SHALL NOT, UNDER ANY CIRCUMSTANCES, BE LIABLE TO PURCHASER, OR ANY OTHER PARTY, FOR CONSEQUENTIAL, INCIDENTAL, SPECIAL OR EXEMPLARY DAMAGES ARISING OUT OF OR RELATED TO THE SALE OR USE OF THE PRODUCT SOLD HEREUNDER.

EXCLUSIVE REMEDY AND LIMITATION OF LIABILITY. WHETHER IN AN ACTION BASED ON CONTRACT, TORT (INCLUDING NEGLIGENCE OR STRICT LIABILITY) OR ANY OTHER LEGAL THEORY, ANY LIABILITY OF VIKING SHALL BE LIMITED TO REPAIR OR REPLACEMENT OF THE PRODUCT, OR AT VIKING'S OPTION, REFUND OF THE PURCHASE PRICE AS THE EXCLUSIVE REMEDY AND ANY LIABILITY OF VIKING SHALL BE SO LIMITED.

IT IS EXPRESSLY UNDERSTOOD AND AGREED THAT EACH AND EVERY PROVISION OF THIS AGREEMENT WHICH PROVIDES FOR DISCLAIMER OF WARRANTIES, EXCLUSION OF CONSEQUENTIAL DAMAGES, AND EXCLUSIVE REMEDY AND LIMITATION OF LIABILITY, ARE SEVERABLE FROM ANY OTHER PROVISION AND EACH PROVISION IS A SEPARABLE AND INDEPENDENT ELEMENT OF RISK ALLOCATION AND IS INTENDED TO BE ENFORCED AS SUCH.

FCC REQUIREMENTS

This equipment complies with Part 68 of the FCC rules and the requirements adopted by the ACTA. On the side of this equipment is a label that contains, among other information, a product identifier in the format US:AAAEQ#TXXXX. If requested, this number must be provided to the telephone company.

The REN is used to determine the number of devices that may be connected to a telephone line. Excessive RENs on a telephone line may result in the devices not ringing in response to an incoming call. In most but not all areas, the sum of the RENs should not exceed five (5.0). To be certain of the number of devices that may be connected to a line, as determined by the total RENs, contact the local telephone company. For products approved after July 23, 2001, the REN for this product is part of the product identifier that has the format US:AAAEQ#TXXXX. The digits represented by ## are the REN without a decimal point (e.g., 03 is a REN of 0.3). For earlier products, the REN is separately shown on the label.

The plug used to connect this equipment to the premises wiring and telephone network must comply with the applicable FCC Part 68 rules and requirements adopted by the ACTA. If your home has specially wired alarm equipment connected to the telephone line, ensure the installation of this RC-2A does not disable your alarm equipment. If you have questions about what will disable alarm equipment, consult your telephone company or a qualified installer.

If the RC-2A causes harm to the telephone network, the telephone company will notify you in advance that temporary discontinuance of service may be required. But if advance notice isn't practical, the telephone company will notify the customer as soon as possible. Also, you will be advised of your right to file a complaint with the FCC if you believe it is necessary.

The telephone company may make changes in its facilities, equipment, operations, or procedures that could affect the operation of the equipment. If this happens, the telephone company will provide advance notice in order for you to make the necessary modifications to maintain uninterrupted service.

If trouble is experienced with the RC-2A, for repair or warranty information, please contact:

Viking Electronics, Inc., 1531 Industrial Street, Hudson, WI 54016 (715) 386-8666

If the equipment is causing harm to the telephone network, the telephone company may request that you disconnect the equipment until the problem is resolved.

Connection to Party Line Service is subject to State Tariffs. Contact the state public utility commission, public service commission or corporation commission for information.

WHEN PROGRAMMING EMERGENCY NUMBERS AND (OR) MAKING TEST CALLS TO EMERGENCY NUMBERS:

Remain on the line and briefly explain to the dispatcher the reason for the call. Perform such activities in the off-peak hours, such as early morning or late evenings.

It is recommended that the customer install an AC surge arrester in the AC outlet to which this device is connected. This is to avoid damaging the equipment caused by local lightning strikes and other electrical surges.

PART 15 LIMITATIONS

This equipment has been tested and found to comply with the limits for a Class A digital device, pursuant to Part 15 of the FCC Rules. These limits are designed to provide reasonable protection against harmful interference when the equipment is operated in a residential environment. This equipment generates, uses, and can radiate radio frequency energy and, if not installed and used in accordance with the instruction manual, may cause harmful interference to radio communications. Operation of this equipment in a residential area is likely to cause harmful interference in which case the user will be required to correct the interference at his own expense.

Product Support: (715) 386-8666

Due to the dynamic nature of the product design, the information contained in this document is subject to change without notice. Viking Electronics, and its affiliates and/or subsidiaries assume no responsibility for errors and omissions contained in this information. Revisions of this document or new editions of it may be issued to incorporate such changes.