

Telecommunication Peripheral Products

Technical Practice

DVA-500A

Digital Voice
Announcer

October 26, 2004

Non-Volatile Digital Voice Announcer with Remote Recording and Transfer Capabilities

The **DVA-500A** is a professional and cost-effective digital voice announcer specifically designed for ACD/UCD, auto attendant, intercept, night message, information provider applications and other PABX and Centrex announcement functions.



The **DVA-500A** will increase call handling capacity by answering on demand or during the first ring and automatically adjusting the announce cycle to the message length. The **DVA-500A** disconnects on CPC and provides instant "rewind" for the next caller.

The **DVA-500A** is factory installed with 1 minute of non-volatile record time. Recordings are retained for 25 years or more without power or batteries.

<http://www.VikingElectronics.com>

E-mail...Sales@VikingElectronics.com

Features

- Up to 1 minute of record time
- Remotely recordable
- Locally recordable using a standard carbon handset or tapeplayer
- Selectable ring delay
- Detects CPC signal and disconnects
- Callers may be transferred after the announcement (see page 6, paragraph A, 3)
- Messages stored in non-volatile memory (no batteries required)
- Recording volume LED indicator for consistently high-quality recordings
- Recognizes handshake signals from virtually any PABX, Centrex or C.O. line
- Programmable to repeat announcement

Sales...(715) 386 - 8861

Applications

- ACD/UCD announcements
- Intercept announcement
- Announce-only applications
- School closings
- Ski reports
- Night answer
- Wake-up calls
- Bank rates/commodity prices
- Any application where information must be repeated continuously and may require frequent updating
- Replace existing tape and drum recorders

Specifications

Power: 120V AC/12V DC 500 mA, UL listed adapter provided
Dimensions: 127mm x 127mm x 38mm (5" x 5" x 1.5")
Shipping Weight: 1.13 kg (2.5 lbs.)
Environmental: 0°C to 32°C (20°F to 90°F) with 5% to 95% non-condensing humidity
Message Length: Up to 1 minute
Connections: (1) RJ11, (1) 4-wire E&M, (1) 1/8 audio jack, (1) handset jack
Sampling Rate: 64 K (equivalent)

Installation

A. Installing the DVA-500A

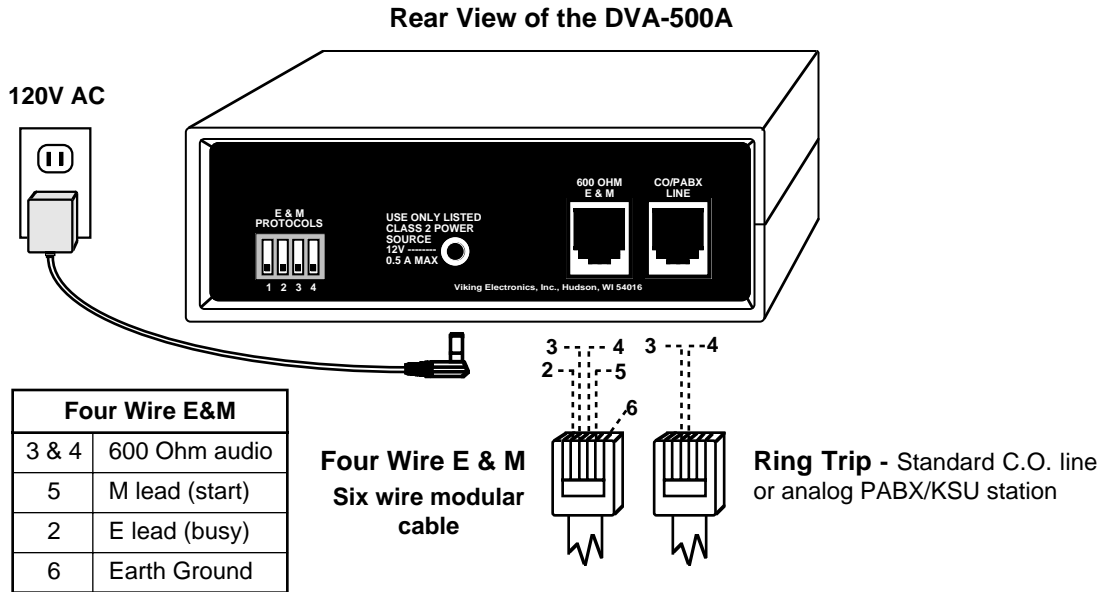

Wire the **DVA-500A** with either or both the 4 wire E&M jack and/or the 2 wire ring trip jack as shown above. When using the 4 wire E&M, the ring trip interface may be used for remote programming. The E&M functions will resume when programming is finished.

Note: The **DVA-500A** requires a 24 hour unswitched 115V AC outlet. To protect the internal electronics, the installation of a surge protector is recommended.

Programming

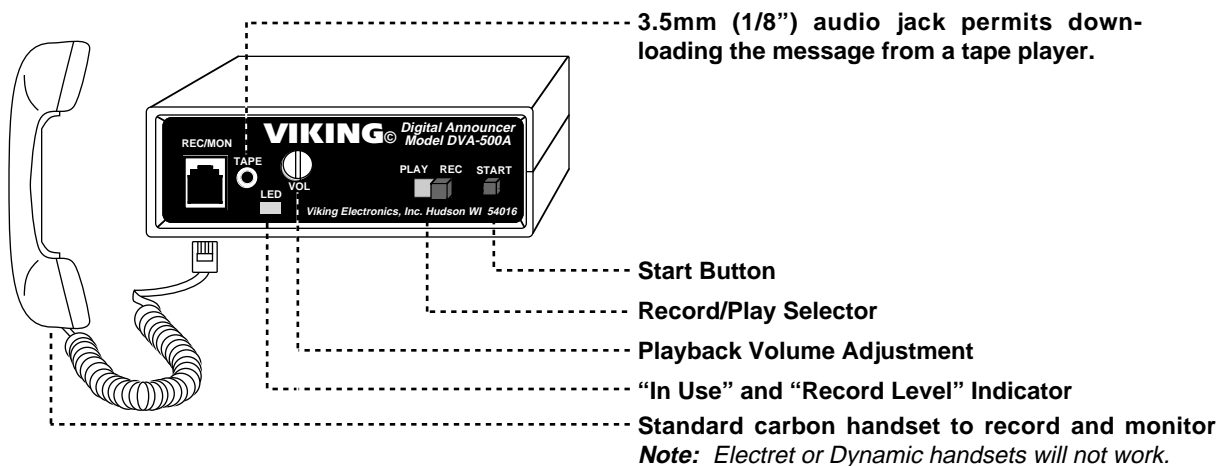

A. Continuous Play

Set dip switches to protocol **A**. Connect pin 5 (start) to pin 2 (busy). The announcement will be repeated continuously on pins 3 and 4 (600 ohm output).

B. E & M Protocol Settings and Timing Specifications

Three different protocol settings are switch selectable for changing E&M timing plus the ability to invert the start and/or busy signals. Place the DIP switches in the desired settings, then momentary power down the **DVA-500A**.

Protocol	Sw 1	Sw 2
A	OFF	OFF
B	OFF	ON
C	ON	OFF

Switch	Position	Description
3	ON	Inverted Start
	OFF	Normal
4	ON	Inverted Busy
	OFF	Normal

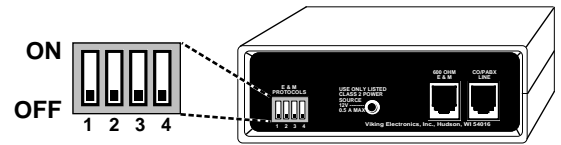

1. "On Demand". Set dip switches to protocol "A" (Sw 1 and Sw 2 - OFF).

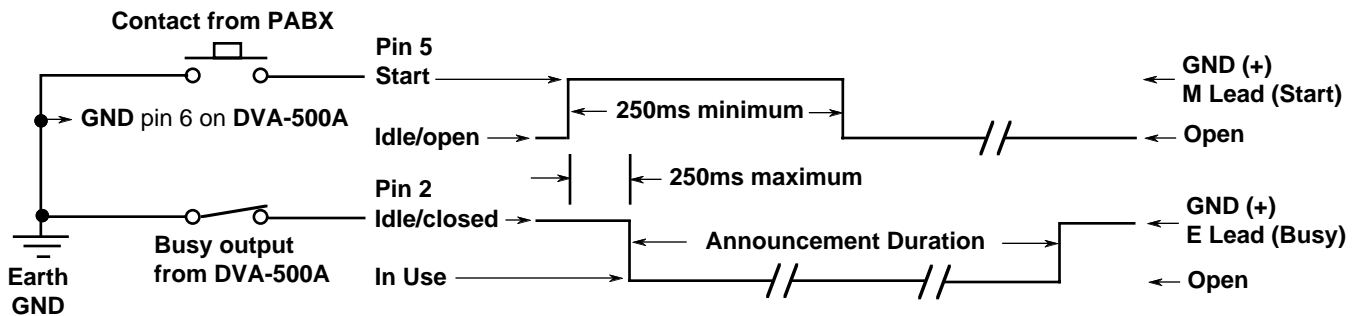

2. Type 5 E & M, wink start. Set dip switches to protocol "B" (Sw 1 - OFF, Sw 2 - ON).

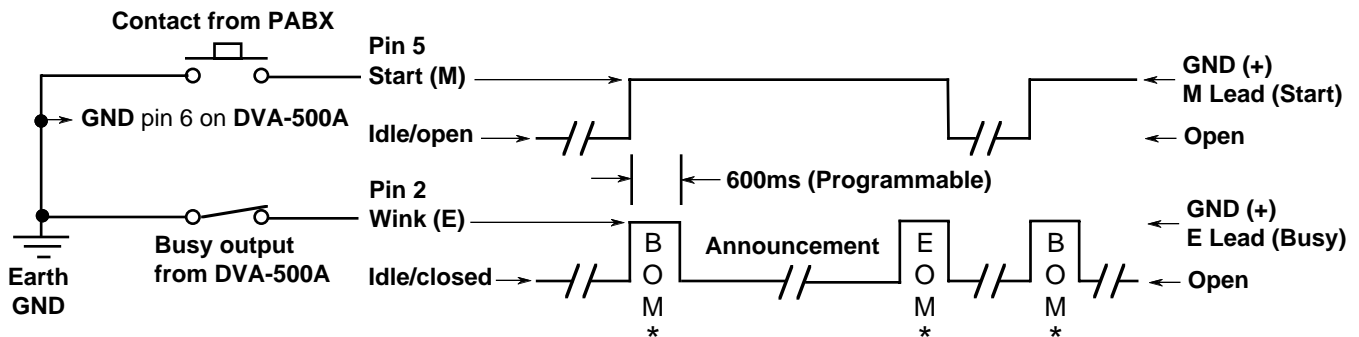

3. Drum Recorder Replacement. Set dip switches to protocol "A" (Sw 1 and Sw 2 - OFF).

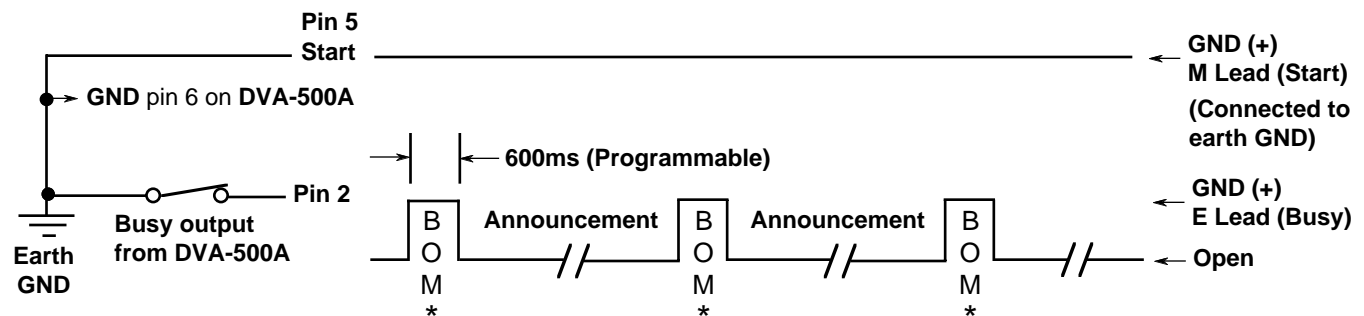

4. Single Play On Demand. Set dip switches to protocol "C" (Sw1 - ON, Sw 2 - OFF).

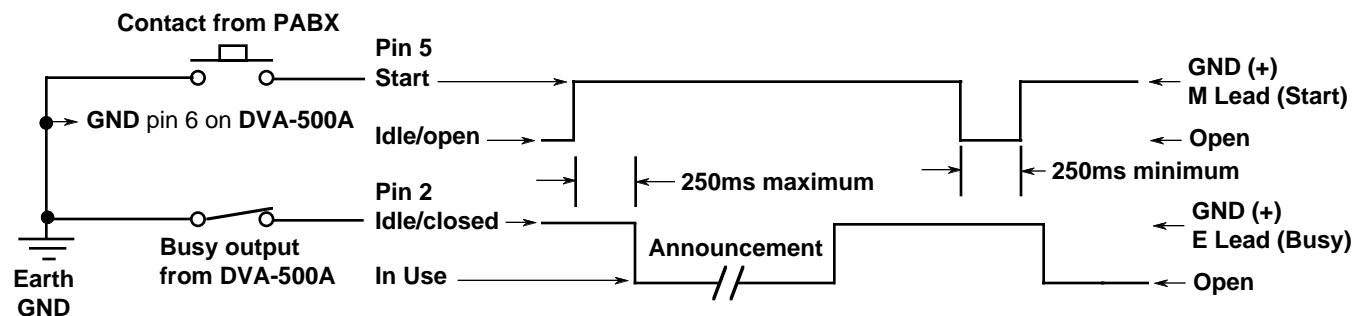

*NOTE: BOM = "Beginning Of Message" pulse. EOM = "End Of Message" pulse.

C. Recording Locally From a Carbon Handset

1. Place the **PLAY/REC** switch in the **REC** position.
2. Plug a standard carbon handset into the modular **REC/MON** jack.
3. Press and hold the **START** switch and begin speaking as if you were talking on the telephone.
4. When finished release the **START** switch.
5. Place the **PLAY/REC** switch in the **PLAY** position.

D. Recording Locally From a Tape Player

1. Place the **PLAY/REC** switch in the **REC** position.
2. Insert a 3.5mm (1/8") audio jack into the **TAPE** jack.
3. Connect the other end of the cable assembly to the speaker, monitor, earphone, etc. jack of a standard cassette recorder.
4. To adjust the audio level of the tape player.
 - a. Play the recording but do not push **START**.
 - b. Adjust the cassette player volume so that the LED flickers but is not mostly on or off.
5. Press and hold the **START** switch for the duration of the recording.
6. When finished release the **START** switch.
7. Place the **PLAY/REC** switch in the **PLAY** position.

E. Monitoring Locally From a Carbon Handset

1. Place the **PLAY/REC** switch in the **PLAY** position.
2. Plug a standard carbon handset into the modular **REC/MON** jack.
3. Press and hold the **START** switch for the duration of the message.
4. When finished release the **START** switch.

Note: While playing or recording, the "LED" will display a steady light.

F. Recording/Programming Remotely From a Touch Tone Phone

1. Accessing the Remote Recording/Programming Mode

- a. Call the C.O. line or analog PABX/KSU extension connected to the 2 wire ring trip port.
- b. When the **DVA-500A** answers, enter a **★**.
- c. After the recording stops, enter your security code (factory set to 845464). Two beeps should be heard.
- d. You are now in the remote recording/programming mode.

2. Remote Recording

- a. After entering the programming mode, enter **★1**, wait for the start tone.
- b. Begin recording your message. Enter **#** to stop the recording.
- c. To review the announcements, enter **★3**, or hang-up and wait 20 seconds for the unit to disconnect, then call in.
- d. Enter **#** to stop the message playback.

3. Programming the Ring Delay Remotely

- a. After entering the programming mode, enter the desired ring delay (**0 - 9**).
- b. Enter **#45**. You have now finished programming your ring delay.

4. E & M Timing

The Beginning Of Message and End Of Message pulse width is factory set to 600ms. This may be programmed from 100ms (Touch Tone **1**) to 900ms (Touch Tone **9**). Enter **1 - 9, #46**.

5. Repeat Announcement

When in programming enter **01-99, #44** to have the announcement play from 1 to 99 times.

6. Changing the Security Code

It is recommended that you change the security code from the **845464** factory setting to your own personal 6 digit number. To change the security code, enter **6 digits #47**. *Note: The security code cannot contain a **★** or **#**.*







7. Transfer Option

When in programming enter the extension number, up to 16 digits, followed by #00 (see page 6, paragraph A, 3).

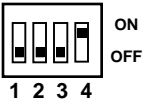
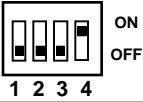
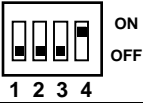
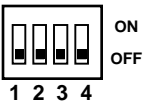
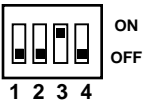
8. To Leave the Remote Programming Mode

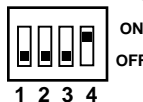
Simply hang-up and the DVA-500A will time-out and disconnect.

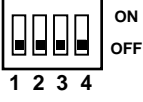
G. Using the DVA-500A with Major PABX's

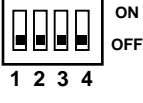
Manufacturer	Protocol Dip Switches	Notes * Earth ground is the positive of the PABX system talk battery
ATT (Dimension, Horizon, etc. 4 Wire E & M)	<p>Protocol "A" with inverted busy signal</p> 	Use 4 Wire E & M Interface. Connections: T & R to pins 3 & 4, M to pin 5, E to pin 2 and Earth Ground* to pin 6.
ATT (System 75)	<p>Protocol "A" with inverted busy signal</p> 	For more information, contact Viking Product Support at (715) 386-8666.
ATT (System 85) SN231 Circuit Pack	<p>Protocol "A" with inverted busy signal</p> 	Use 4 Wire E & M Interface. Connections to SN231 Circuit Pack. T & R to pins 3 & 4, S to pin 5, and AL to pin 2. Set option switches 1 & 2 down and 3 up on the Circuit Pack.
Conveyant	<p>Protocol "A"</p> 	Use 4 Wire E & M Interface. Connections: T & R to pins 3 & 4. Strap pin 5 (from the DVA-500A) to pin 6 (of the DVA-500A). Don't connect any Earth Ground. RC-T1 (control input) lead to pin 2. CONVEYANT logic ground to pin 1.
GTE	<p>Protocol "A" with inverted start signal</p> 	Use 4 Wire E & M Interface. Connections: T & R to pins 3 & 4, M to pin 5, E to pin 2 and Frame Ground to pin 6.
Harris (20-20)	<p>Protocol "B"</p> 	Use 4 Wire E & M Interface. Connections: T1 & R1 to pins 3 & 4. M to pin 5. E to pin 2. Earth ground* to pin 6.
Hitachi (HCX 5000)	<p>Protocol "A" with inverted busy signal</p> 	For more information, contact Viking Product Support at (715) 386-8666.
N.E.C. (2400)	<p>Protocol "C"</p> 	Use 4 Wire E & M Interface. Connections to 40DT card: T1 & R1 to pins 3 & 4. M to pin 5. Earth ground* to pin 6.
Northern (SL-1) QPC74 Ran Trunk	<p>Protocol "A"</p> 	Use 4 Wire E & M Interface. Connections to QPC74 RAN TRUNK circuit pack: T & R to pins 3 & 4. CPO to pin 2. S/MB0 to pin 5. Earth ground* to pin 6. Set C34 switch as follows: SW1.0 - closed, SW2.0 - closed, SW3.0 - open, SW4.0 - closed. Programming the SL-1: The DVA-500A emulates a Cook 201.
Northern (SL-1) Universal trunk card	<p>Protocol "A"</p> 	Use 4 Wire E & M Interface. Connections to Universal TRUNK card: T & R to pins 3 & 4. Earth ground* to pin 6. Pin 5 to MB lead. Pin 2 to CP lead. The DVA-500A emulates a Audiochron RQ1-112.
Siemens (Saturn)	<p>Protocol "A"</p> 	Use 4 Wire E & M Interface. Connections to the TMBA-4 card: T & R to pins 3 & 4. MA to pin 5. Strap MA & EB together. Don't connect EA lead. Program Saturn for "Recann" and "Demand" and set "System Message" to be a min. of 2 sec. longer than actual announcement. Strap TMBA-4 for type 2 signaling.

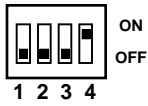
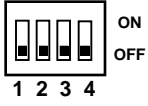
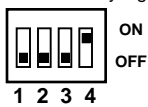
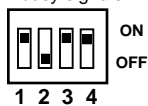
Manufacturer	Protocol Dip Switches	Notes * Earth ground is the positive of the PABX system talk battery
Siemens (40/80 Hybrid)	Protocol "A" with inverted busy signal 	For more information, contact Viking Product Support at (715) 386-8666.
Startel	Protocol "A" 	Use 4 Wire E & M Interface. Connections: T & R to pins 3 & 4, M to pin 5, E to pin 2. No connection to pin 6.
Stromberg-Carlson (CO switch)	Protocol "A" with inverted busy signal 	Use 4 Wire E & M Interface. Connect T & R to pins 3 & 4, Earth Ground* to pin 6 and pin 5, and E to pin 2. Strap the E & M Trunk card the same as for an Audichron HQ1 112 Drum Announcer. Programming the CO switch: The DVA-500A emulates the Audichron Drum Announcer.
Stromberg-Carlson (DBX)	Protocol "C" with inverted start and busy signals 	Use 4 Wire E & M Interface. Connections: T & R to pins 3 & 4, M to pin 5, E to pin 2. Earth Ground* to pin 6.
Tadaran (All models)		Use Ring Trip Interface. Connect T & R to pins 3 & 4 of the CO/PABX line jack. Program all DVA-500A channels for ring delay of 2.
Jistel (all models) Mitel (all models) Rolm (all models) Toshiba (perception)		Use Ring Trip Interface. Connect T & R to pins 3 & 4 of the CO/PABX line jack.

Operation

A. Ring Trip Interface

1. **Standard** - Any ringing C.O. line or analog PABX/KSU station will be answered after the programmed ring delay, given the announcement and released. The DVA-500A is then immediately ready to answer the next incoming call.
2. **Repeat Announcement Option** - The announcement may be programmed to play up to 99 times. The announcement will repeat, up to the programmed value, or until the caller hangs up and a CPC signal from the C.O. is detected. Callers that do not hang up may be transferred (see below). When in programming, enter the repeat announcement value **01** (plays once) to **99** followed by **#44**.
3. **Transfer Option** - A ringing C.O. line will be answered after the programmed ring delay, given the announcement and then transferred to another extension. This option may only be used with analog PABX/KSU, OPX station or Centrex C.O. lines with hook switch flash - blind transfer capabilities. This means a line that a "2500" set telephone can hookswitch flash and dial an extension, but does not require that extension to answer before releasing the call. When in programming, enter the extension number to be transferred to (up to 16 digits) followed by **#00**. To remove the transfer option simply enter **#00** without any previous (extension) numbers.

B. Four Wire E & M

The **600 OHM E & M** jack provides a 600 ohm "Dry" output. Refer to E & M protocol settings and timing on pages 3 - 4, and the PABX table on pages 5 - 6 for proper operation.

Product Support Line...(715) 386-8666

Fax Back Line...(715) 386-4345

Due to the dynamic nature of the product design, the information contained in this document is subject to change without notice. Viking Electronics, its affiliates and/or subsidiaries assume no responsibility for errors and/or omissions contained in this information. Revisions of this document or new editions of it may be issued to incorporate such changes.