

VIKING PRODUCT MANUAL

COMMUNICATION & SECURITY SOLUTIONS

C-3000
Apartment
Entry System
 February 12, 2014

Add Apartment Entry Without Rewiring

This entry system is designed to utilize a building's existing telephone wiring and to address a variety of apartment entry applications. Viking's **C-3000** Entry System provides secure multi-tenant building access, without the need for any C.O. lines; the only requirement is that each tenant have a touch-tone telephone set wired to their apartment. The **C-3000** performs equally as well in installations where C.O. lines are present. An individual **C-3000** module has a 12-tenant capacity; for larger applications, a maximum of eight (8) **C-3000** modules can be interconnected, allowing a total system capacity of up to 96 tenants. A **C-3000** system consists of at least one Master **C-3000** module, and as many as seven Slave modules.

From either of two entry doors, visitors may ring a tenant's telephone with a distinctive cadence, alerting the tenant of their arrival. The **C-3000** provides call waiting tones if the tenant's line is in use. The tenant may then converse freely with the visitor via their existing telephones. Once identified, the ten-



ant can let the visitor in by entering a single touch-tone on the keypad of the tenant's telephone set.

The **C-3000** keyless entry feature supports unique entry codes for each tenant. As a measure of security, the codes can be easily changed as tenants move in and out of the building. A postal lock feature is also supplied as an added convenience.

Features

- Utilizes building's existing telephone wiring, yet functions with or without tenant CO lines
- No monthly charges for a dedicated line
- Tenants do not require phone service
- Programmable keyless entry code for each tenant
- Distinctive ring cadence and call waiting
- Programmable from dedicated programming phone
- Supports (2) entry doors and (2) door strikes
- 12-tenant capacity may be expanded to 96 tenants at any time
- Compatible with Viking's vandal resistant **K-1700-3**, **K-1900-8** or any Touch Tone phone
- May be wired so that tenants may talk to visitors without disrupting C.O. modem transmissions
- Allows visitors to leave voice messages on tenants personal answering machines

Applications

- Apartments and condominiums
- Buildings where some or all tenants lack phone service
- Supervised living
- Student housing
- Retrofit older construction

Specifications

Power: 120VAC / 13.8VAC 1.25A, UL listed adapter provided

Dimensions: 211mm x 160mm x 46mm (8.30" x 6.30" x 1.80")

Shipping weight: 1.0kg (2.2 lbs.)

Environmental: 0° C to 32° C (32° F to 90° F) with 5% to 95% non-condensing humidity

Talk battery: 40VDC

Relay contact ratings: 5A @ 30VDC / 250VAC

Maximum System Door Phones/Door Strikes: (2) each

Maximum System Tenant Capacity: 96 - using (8) **C-3000** modules

Ring Generator: 90V AC nominal, 7 REN maximum

Connections: (1) RJ-21X female 25-pair, (3) RJ-11 female, (13) terminal block positions

www.vikingelectronics.com

Information: (715) 386-8861

A. Definitions

Master Module: The **C-3000** module assigned module ID #1. Also, the only module in a single-module system.

Slave Module(s): Any module(s) in addition to the Master, in a multi-module **C-3000** system. Slave modules are assigned module ID numbers in the range of #2 through #8.

“66” Punch Down Terminal Block: A connection peripheral used to interface telephone lines easily. This installation requires a “split” punch down block.

B. Preparing the Installation

Select an appropriate location in which to install the **C-3000** System. It is normally most convenient to install the **C-3000** modules as near as possible to the telco demarcation point; that is, the common point at which all tenant phone lines enter the building (if applicable). If the tenant phone wiring is not currently cabled though a “66” block or blocks, it will be necessary to install “66” block(s) at this time to facilitate the installation of the **C-3000** system.









Note: See the installation diagram on the following page for recommendations on which “66” block to use.

C. Assigning Module ID Numbers

A **C-3000** system consists of at least one (Master) **C-3000** module, and as many as seven (7) Slave modules. Multiple **C-3000** modules are all interconnected from module to module, using the supplied modular cords, connecting the MULTI-MODULE INTERCONNECTS from IN to OUT. If more than one **C-3000** module is being installed, it will be necessary to set module ID numbers at this time. Each **C-3000** module must have its own ID number to be part of a **C-3000** system. Module ID numbers are set using the three-position DIP switches on the front of the **C-3000** modules (see diagram below). Module ID numbers are used to determine which **C-3000** module is responsible for handling a particular range of apartment numbers. As an example, Module #1 (the Master module) handles apartment numbers 1-12, Module #2 handles apartment numbers 13-24 and so forth.

D. Wiring Table

Refer to the wiring table below when installing the cabling for the **C-3000** system. Note that tenant line 1 enters on pins 1 & 26 of the RJ-21X connector, and exits on pins 2 & 27 of the same connector. This also means a visitor would dial a touch tone 1 to call the tenant connected to line 1. This scheme is used on all 12 lines on the RJ-21X connector, occupying all pins up through the pin 24 & 49 pair, and repeats on up to the 96th tenant on the 8th module. The last pair on the RJ-21X connector (pins 25 & 50) has a special function. This last pair is used (on the Master module only) as a connection for the Building Manager’s Programming Phone.

Module ID Assignment	Module 1	Module 2	Module 3	Module 4	Module 5	Module 6	Module 7	Module 8	RJ-21X Connector		
	“Master”	“Slave”	“Slave”	“Slave”	“Slave”	“Slave”	“Slave”	“Slave”	Tip	Ring	
Dip Switch Settings	ON  OFF	ON  OFF	ON  OFF	ON  OFF	ON  OFF	ON  OFF	ON  OFF	ON  OFF	ON  OFF		
		1 2 3	1 2 3	1 2 3	1 2 3	1 2 3	1 2 3	1 2 3	1 2 3		
C.O. Lines In	1	13	25	37	49	61	61	85	26 W/BL	1 BL/W	
	2	14	26	38	50	62	62	86	28 W/G	3 G/W	
	3	15	27	39	51	63	63	87	30 W/S	5 S/W	
	4	16	28	40	52	64	64	88	32 R/O	7 O/R	
	5	17	29	41	53	65	65	89	34 R/BN	9 BN/R	
	6	18	30	42	54	66	66	90	36 BK/BL	11 BL/BK	
	7	19	31	43	55	67	67	91	38 BK/G	13 G/BK	
	8	20	32	44	56	68	68	92	40 BK/S	15 S/BK	
	9	21	33	45	57	69	69	93	42 Y/O	17 O/Y	
	10	22	34	46	58	70	70	94	44 Y/BN	19 BN/Y	
	11	23	35	47	59	71	71	95	46 V/BL	21 BL/V	
	12	24	36	48	60	72	72	96	48 V/G	23 G/V	
Lines Out to Apartment Phones (Dial Up Codes)	1	13	25	37	49	61	61	85	27 W/O	2 O/W	
	2	14	26	38	50	62	62	86	29 W/BN	4 BN/W	
	3	15	27	39	51	63	63	87	31 R/BL	6 BL/R	
	4	16	28	40	52	64	64	88	33 R/G	8 G/R	
	5	17	29	41	53	65	65	89	35 R/S	10 S/R	
	6	18	30	42	54	66	66	90	37 BK/O	12 O/BK	
	7	19	31	43	55	67	67	91	39 BK/BN	14 BN/BK	
	8	20	32	44	56	68	68	92	41 Y/BL	16 BL/Y	
	9	21	33	45	57	69	69	93	43 Y/G	18 G/Y	
	10	22	34	46	58	70	70	94	45 Y/S	20 S/Y	
	11	23	35	47	59	71	71	95	47 V/O	22 O/V	
	12	24	36	48	60	72	72	96	49 V/BN	24 BN/V	
Building Mgr Phone	n/a	n/a	n/a	n/a	n/a	n/a	n/a	n/a	50 V/S	25 S/V	

E. Standard Wiring

Note: If the Master C-3000 is powered up first, it is normal for the power LED's of all C-3000's to light.

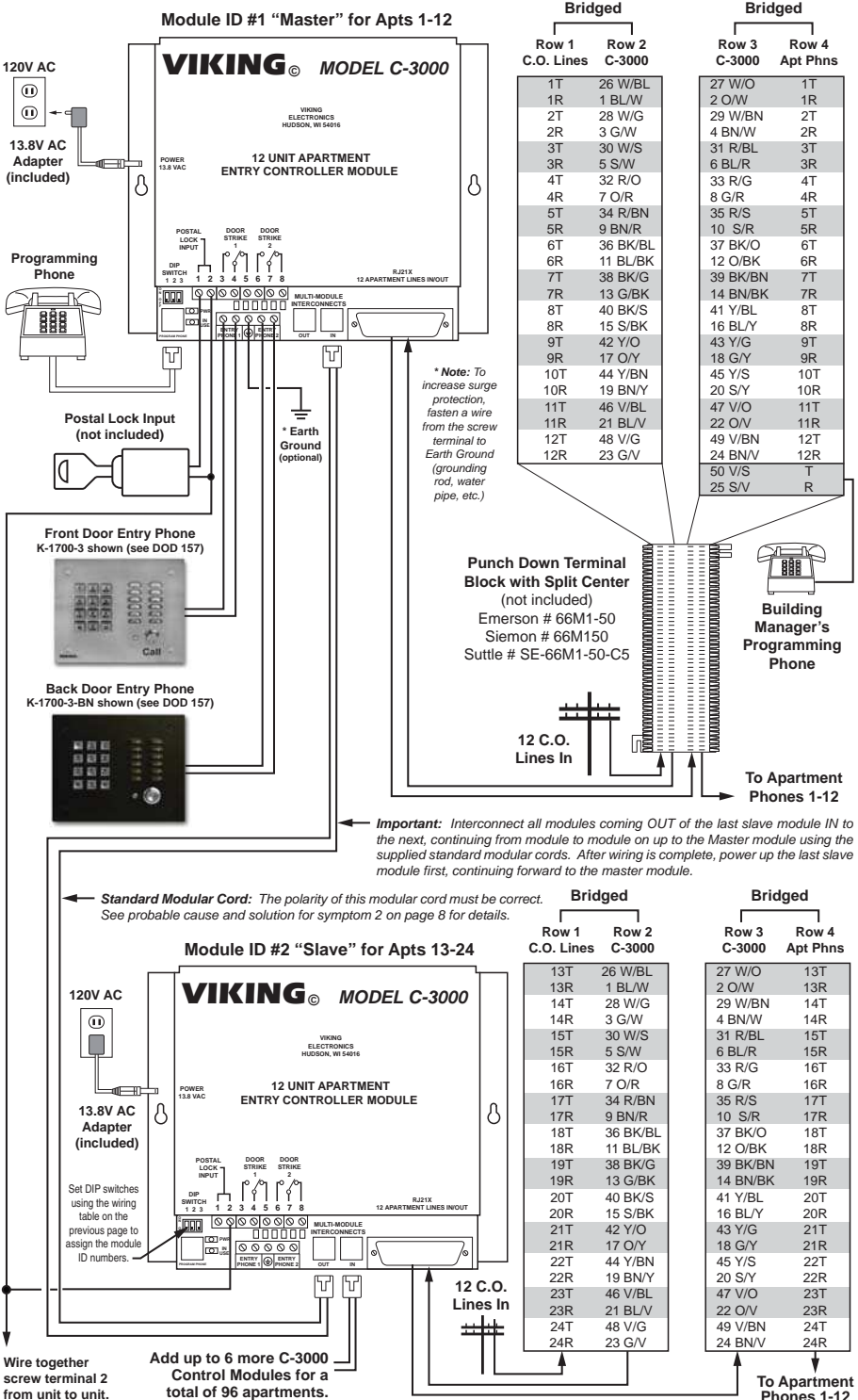

F. Wiring with Modems (including DSL Lines)

The C-3000 may be wired with this alternate wiring scheme which allows tenants to talk to their visitors without disrupting their C.O. modem transmissions, or losing DSL carrier signals. It requires two pair runs and RJ-14 jacks for each apartment. In this scheme, the modem will be connected to the Y/BK pair of the RJ-14 which is wired ahead of the C-3000, directly to the C.O. line. Use a 2 line splitter to connect the modem to the Y/BK pair. Wiring in this manner for all apartments assures a smooth transition as tenants add modems and DSL service in the future.

1. Concept

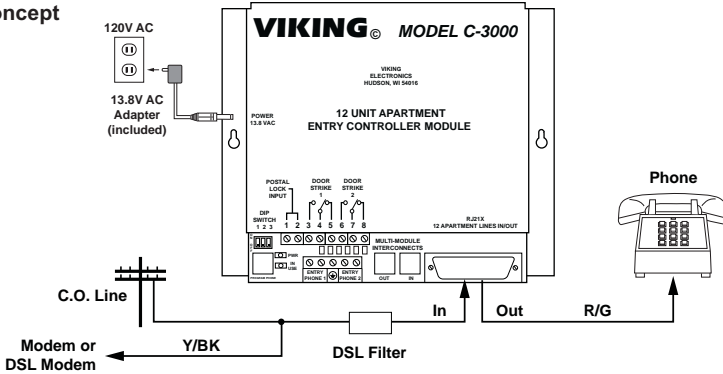

2. Detailed Example

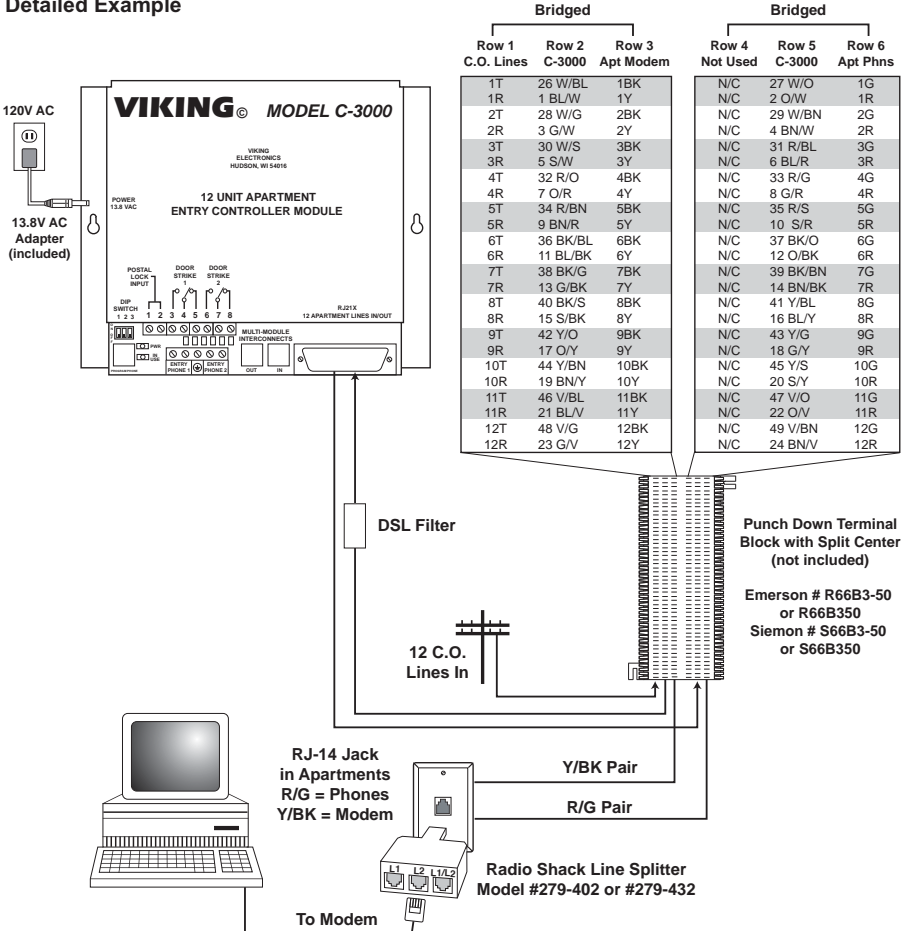

G. Door Strike Relay Wiring

Use the relay contacts of the Master module to activate door strikes, magnetic locks, and gate controls. Normally closed, normally open and common contacts are provided for both entry locations.

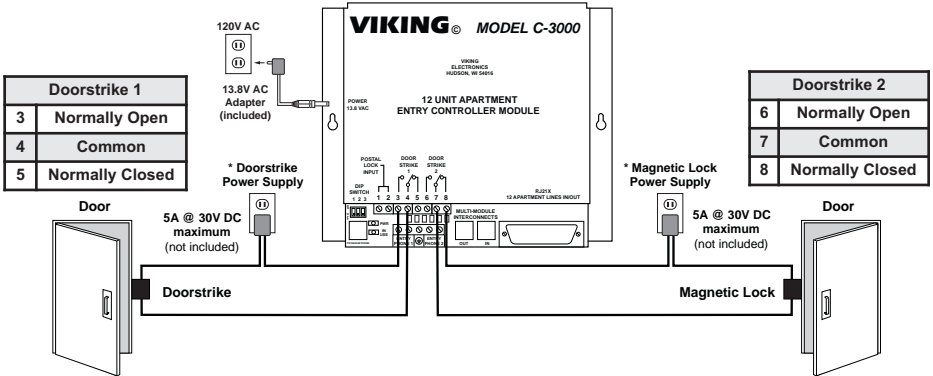

Programming

A. Definitions

Program Phone: A single line telephone or buttset connected to the Program Phone port (RJ-11) of a C-3000 module.

Building Manager's Programming Phone: A single line telephone or buttset connected to pins 25/50 so that the Building Manager may easily change keyless entry codes, without the necessity of travelling to the C-3000 system.

Tenant Keyless Entry code: A four to six-digit code assigned to a tenant, which is used to gain access to the building through the C-3000 system. Keyless entry codes are programmed into memory positions #01-#96. There are no factory default settings for these values, nor is it a requirement that they be set.

Master Keyless Entry Code: A single four to six-digit code, which is normally not assigned to a tenant, but may be made known to the building manager, maintenance or security personnel. The Master keyless entry code is programmed into memory position #00. There is no factory default setting for this value, nor is there a requirement that it be set.

Relay Activation Time: The period of time (in seconds) for which a C-3000 door strike relay will remain activated, after having been given an activation code. This value is factory preset to (5) seconds.

Relay Activation Code: The one-digit code entered on a tenant's touch-tone telephone keypad, which will activate a door strike relay to allow a visitor access to the building. This code is factory preset to "6".

Maximum Call Time: The maximum time (in minutes) allowed for a single conversation between a visitor at the door phone and a tenant. If this time is exceeded, both parties will be disconnected. This value is factory preset to (2) minutes.

Maximum Ring Count: The maximum number of times the C-3000 system will ring any tenant's telephone, after being activated by a visitor at the door phone. This value is factory preset to (7) rings.

Number of Modules: The sum total of C-3000 modules in the C-3000 system. This value is factory preset to (1).

B. Quick Programming Guide

Master Module Set Up	Enter Digits	- then -	Memory Location
Number of modules (1-8, factory set to 1)	1 digit	+	##8
Master keyless entry code (4-6 digits, no digits disables)	4-6 digits	+	#00
Tenants keyless entry codes (4-6 digits, no digits disables)	4-6 digits	+	#01 - #96
Clear all keyless entry codes and set all programming features to factory settings....			###
Slave and Master Module Set Up			
Relay activation time (0-9, factory set to 5 sec, 0=.5 sec)	1 digit	+	##3
Relay activation code (factory set to 6) (cannot be a # or a *) (no digit=disable)	1 digit	+	##4
Maximum entry phone time (0-9, factory set to 2 min, 0=disabled)	1 digit	+	##6
Maximum ring count (0-9, factory set to 7, 0=10)	1 digit	+	##7

C. Master C-3000 Module Setup

The following setup procedures are performed only on the Master module (ID #1) in the C-3000 system. Come off-hook with the Program Phone on the Master module, and program the following settings.

1. Set Number of Modules

(1 digit, 1-8) + ##8 **Example:** If the C-3000 system will consist of (4) modules, you would come off hook with the programming phone and enter "4##8." Two beeps will confirm a valid entry, three beeps will signify an error. This value is factory preset to (1).

2. Set Master Keyless Entry Code (optional)

(4-6 digits, 0-9) + #00 -or- #00 alone to clear this position **Example:** To set the Master Keyless entry code to "052069" you would come off-hook with the Program Phone and enter "052069#00." Entering "#00" without any leading digits will clear this position. Two beeps will confirm a valid entry, three beeps will signify an error. **Note:** *The entry codes should all be the same number of digits, either 4, 5 or 6.*

3. Set Tenant Keyless Entry Codes (optional)

(4-6 digits, 0-9) + #01-#96 -or- #01-#96 alone to clear that position **Example:** To set the Tenant Keyless Entry code for apartment "24" to "052069" you would come off-hook with the Program Phone and enter "052069#24." Entering "#01" through "#96" without any leading digits will clear the respective position. Two beeps will confirm a valid entry, three beeps will signify an error. Note that there are 96 tenant keyless entry codes available regardless of how many C-3000's have been installed. For example, in an installation with just one C-3000, the first 12 keyless entry codes corresponding to memory positions #01-#12 can each be individually assigned to one of the 12 apartments. However, the remaining 84 keyless codes corresponding to memory position #13-#96 are still available and will be functional if programmed, allowing for more than one keyless entry code per apartment or keyless codes specifically assigned for maintenance personnel. It is important to carefully document any codes that are programmed so that they can be cleared if required. **Note:** *The entry codes should all be the same number of digits, either 4, 5 or 6.*

4. Clear All Keyless Entry Code Positions and Set Programming Features to Default (optional)

Example: To clear all Keyless Entry code positions in the entire C-3000 system and return all programming settings back to factory default, enter "###". Two beeps will confirm a valid entry, three beeps will signify an error. **Note:** *Be EXTREMELY careful with the use of this feature, as it will immediately erase ALL keyless entry codes in the system, with no possibility for recovery. It is suggested that this feature be exercised when installing a new C-3000 system, before any other programming is performed.*

D. General C-3000 System Setup

The following procedures are to be performed on each module in the C-3000 system, one module at a time. Note that while each module needs to be programmed separately, it is standard practice to make all of the following settings identical, for all modules. All four system setup programmable features are pre-programmed to factory defaults. If these settings are acceptable, then there is no need for additional programming.

1. Relay Activation Time (.5 - 9 seconds: factory default = 5 seconds)

(1 digit, 0-9) + ##3 ("1"=1 second, "0"=.5 second) **Example:** To set the door strike relay to activate for 8 seconds, you would come off-hook on the Program Phone and enter "8##3". Two beeps will confirm a valid entry, three beeps will signify an error. Repeat this process for each module.

2. Relay Activation Code (factory default = 6)

(1 digit, 0-9) + ##4 **Example:** To set the door strike relay to activate with the code "0", come off-hook with the Program Phone and enter "0##4". Two beeps will confirm a valid entry, three beeps will signify an error. Repeat this procedure for each module.

3. Maximum Entry Phone Time (1-9 minutes: factory default = 2 minutes)

(1 digit, 0-9) + ##6 ("0"=disabled) **Example:** To set the Maximum Entry Phone time limit to 3 minutes, come off-hook with the Program Phone and enter "3##6". Entering "0##6" or just "##6" will disable the time limit. Two beeps will confirm a valid entry, three beeps will signify an error. Repeat this procedure for each module.

4. Maximum Ring Count (1-10 rings: factory default = 7 rings)

(1 digit, 0-9) + ##7 ("0"= 10 rings) **Example:** To set the Maximum Ring Count to 8, come off-hook with the Program Phone and enter "8##7". Two beeps will confirm a valid entry, three beeps will signify an error. Repeat this procedure for each module.

Operation

A. Receiving a Visitor

A visitor arrives, takes the entry phone off-hook and dials a one or two-digit code (1-96), which corresponds to an individual tenant's apartment (see **Wiring Table in Installation section D**). The telephone(s) in the tenant's apartment then begin to ring in a special "double-ring" cadence, notifying the tenant that they have a visitor at the door. The tenant may then answer the call from any phone, and converse normally with the visitor. If the tenant's phone is already in use, the tenant receives a "call waiting" type tone, notifying them of the visitor's call. A hookswitch flash from the tenant's phone will put the current call on hold, and answer the visitor's call. A second hookswitch flash from the tenant's phone will disconnect the visitor's call and return the tenant to the original call, without allowing the visitor access to the building. Note that when either of the two entry phones are in use, the other entry phone is disabled for the duration of the call.

B. Allowing a Visitor Entry

After communicating with a visitor at the door, the tenant can allow the visitor access to the building by entering a programmable code on the tenant's touch-tone telephone. The factory default relay activation code is "6". Upon entering this code, both parties will hear a brief buzzing tone as they are disconnected from the telephones, and the door strike relay operates giving the visitor access to the building. If the tenant had a call in progress, the tenant will also be automatically returned to the original call. If the visitor attempts to enter the relay entry code themselves, the **C-3000** system detects this and automatically disconnects both parties, without activating the doorstrike relay.

C. Keyless Entry

Each tenant can be assigned a unique four to six-digit entry code, which may be used to gain access to the building without their key. In addition to the 96 tenant Keyless Entry codes, there is also one additional "Master" keyless entry code. To access the Keyless Entry feature, the tenant takes an entry phone off-hook and enters "#", plus their keyless entry code. The doorstrike relay will then operate to allow the tenant access to the building. Note that it is not a requirement to set or use the **C-3000** keyless entry feature.

D. Changing Keyless Entry Codes or Programming Features

From the Building Manager's Phone or the "Program Phone" port, all programming, including codes, can be performed. To change a keyless entry code, the Building Manager picks up the Building Manager's Programming phone, (if both entry phones are idle, two beeps will be heard to confirm that the **C-3000** system is ready for programming) and dials: (**New 4-6 digit entry code**) + "#" + (**00-96**)

For example, to set the Keyless Entry code for apartment 24 to "052069", the Building Manager would enter "052069#24" and then hang up, unless additional codes need to be changed. Two more beeps from the Building Manager's programming phone confirm a valid entry, three beeps will signify an error. See the "Programming" section for full details on the procedure for changing keyless entry codes. **Note:** *Both entry phones are disabled during programming.*

E. Postal Lock Feature (Authorized Persons Only)

This feature is provided to allow an authorized person, such as a Postal Service worker to gain access to the building using a special key lock switch dedicated to this purpose. Keying the Postal Lock (momentary contact closure) will activate door strike 1 contacts for about 5 seconds.

Master / Slave Troubleshooting Guide

Symptom 1:

The entry phone is able to call a slave apartment, but when they attempt to dial the relay command ("6" by default), the door/gate doesn't open (the doorstrike contacts of the master C-3000 don't operate). When calling a master apartment and dialing the relay command, the door/gate does open. Also, the doorstrike contacts of the slave C-3000 are activating when the entry phone calls a slave apartment and the party dials the relay command (the slave C-3000's relay would not activate in a working master/slave configuration).

Probable Cause and Solution:

Check the "multi-module interconnect" modular cord between the master and slave (or in larger "stacks", the cord between the first slave C-3000 with the problem and the slave C-3000 ahead of it in the stack). If the cord is only a two conductor modular cord, it must be replaced with a four conductor modular cord. If it is a four conductor modular cord, the cord has an open in the second pair (yellow or black wires) and should be replaced (the polarity of this modular cord must be correct - see Probable Cause and Solution for symptom 2).

Symptom 2:

As soon as the "multi-module interconnect" modular cord is connected from the "in" of the master C-3000 to the "out" of the slave C-3000, the "in-use" LED's light up steady on both C-3000's.

Probable Cause and Solution:

The modular cord being used to connect the C-3000's together is the wrong polarity. The modular cord must be a standard "straight through" modular cord, rather than a "reversed" modular cord. The modular cord supplied with the C-3000 is the correct polarity. Either use the supplied modular cord, or make sure the locking tab is on the same side of the modular cord at both ends, if making your own modular cords.

Symptom 3:

Everything works properly when the entry phone calls an apartment on the master C-3000. When the entry phone tries to call a slave apartment, the entry phone receives both ringback tones and a busy signal (at the same time), as the call is ringing through to the slave apartment.

Probable Cause and Solution:

The master C-3000 has not been properly programmed with the "number of modules" in the stack (##8 memory location). The master C-3000 must be told how many C-3000's are in the stack and this is set to one by default. Program the master with the correct number of units in the stack. See Programming, Section C (Master Module Setup) for programming details.

Warranty

IF YOU HAVE A PROBLEM WITH A VIKING PRODUCT, CONTACT: VIKING TECHNICAL SUPPORT AT (715) 386-8666

Our Technical Support Department is available for assistance Monday through Friday 8am - 5pm central time. So that we can give you better service, before you call please:

1. Know the model number, the serial number and what software version you have (see serial label).
2. Have your Technical Practice in front of you.
3. It is best if you are on site.

RETURNING PRODUCT FOR REPAIR

The following procedure is for equipment that needs repair:

1. Customer must contact Viking's Technical Support Department at 715-386-8666 to obtain a Return Authorization (RA) number. The customer MUST have a complete description of the problem, with all pertinent information regarding the defect, such as options set, conditions, symptoms, methods to duplicate problem, frequency of failure, etc.
2. Packing: Return equipment in original box or in proper packing so that damage will not occur while in transit. Static sensitive equipment such as a circuit board should be in an anti-static bag, sandwiched between foam and individually boxed. All equipment should be wrapped to avoid packing material lodging in or sticking to the equipment. Include ALL parts of the equipment. C.O.D. or freight collect shipments cannot be accepted. Ship cartons prepaid to: **Viking Electronics, 1531 Industrial Street, Hudson, WI 54016**
3. Return shipping address: Be sure to include your return shipping address inside the box. We cannot ship to a PO Box.
4. RA number on carton: In large printing, write the R.A. number on the outside of each carton being returned.

RETURNING PRODUCT FOR EXCHANGE

The following procedure is for equipment that has failed out-of-box (within 10 days of purchase):

1. Customer must contact Viking's Technical Support at 715-386-8666 to determine possible causes for the problem. The customer MUST be able to step through recommended tests for diagnosis.
2. If the Technical Support Product Specialist determines that the equipment is defective based on the customer's input and troubleshooting, a Return Authorization (R.A.) number will be issued. This number is valid for fourteen (14) calendar days from the date of issue.
3. After obtaining the R.A. number, return the approved equipment to your distributor, referencing the R.A. number. Your distributor will then replace the Viking product using the same R.A. number.
4. **The distributor will NOT exchange this product without first obtaining the R.A. number from you. If you haven't followed the steps listed in 1, 2 and 3, be aware that you will have to pay a restocking charge.**

TWO YEAR LIMITED WARRANTY

Viking warrants its products to be free from defects in the workmanship or materials, under normal use and service, for a period of two years from the date of purchase from any authorized Viking distributor. If at any time during the warranty period, the product is deemed defective or malfunctions, return the product to Viking Electronics, Inc., 1531 Industrial Street, Hudson, WI., 54016. Customer must contact Viking's Technical Support Department at 715-386-8666 to obtain a Return Authorization (R.A.) number.

This warranty does not cover any damage to the product due to lightning, over voltage, under voltage, accident, misuse, abuse, negligence or any damage caused by use of the product by the purchaser or others. This warranty does not cover non-EWP products that have been exposed to wet or corrosive environments. This warranty does not cover stainless steel surfaces that have not been properly maintained.

NO OTHER WARRANTIES. VIKING MAKES NO WARRANTIES RELATING TO ITS PRODUCTS OTHER THAN AS DESCRIBED ABOVE AND DISCLAIMS ANY EXPRESS OR IMPLIED WARRANTIES OR MERCHANTABILITY OR FITNESS FOR ANY PARTICULAR PURPOSE.

EXCLUSION OF CONSEQUENTIAL DAMAGES. VIKING SHALL NOT, UNDER ANY CIRCUMSTANCES, BE LIABLE TO PURCHASER, OR ANY OTHER PARTY, FOR CONSEQUENTIAL, INCIDENTAL, SPECIAL OR EXEMPLARY DAMAGES ARISING OUT OF OR RELATED TO THE SALE OR USE OF THE PRODUCT SOLD HEREUNDER.

EXCLUSIVE REMEDY AND LIMITATION OF LIABILITY. WHETHER IN AN ACTION BASED ON CONTRACT, TORT (INCLUDING NEGLIGENCE OR STRICT LIABILITY) OR ANY OTHER LEGAL THEORY, ANY LIABILITY OF VIKING SHALL BE LIMITED TO REPAIR OR REPLACEMENT OF THE PRODUCT, OR AT VIKING'S OPTION, REFUND OF THE PURCHASE PRICE AS THE EXCLUSIVE REMEDY AND ANY LIABILITY OF VIKING SHALL BE SO LIMITED.

IT IS EXPRESSLY UNDERSTOOD AND AGREED THAT EACH AND EVERY PROVISION OF THIS AGREEMENT WHICH PROVIDES FOR DISCLAIMER OF WARRANTIES, EXCLUSION OF CONSEQUENTIAL DAMAGES, AND EXCLUSIVE REMEDY AND LIMITATION OF LIABILITY, ARE SEVERABLE FROM ANY OTHER PROVISION AND EACH PROVISION IS A SEPARABLE AND INDEPENDENT ELEMENT OF RISK ALLOCATION AND IS INTENDED TO BE ENFORCED AS SUCH.

PART 15 LIMITATIONS

This equipment has been tested and found to comply with the limits for a Class A digital device, pursuant to Part 15 of the FCC Rules. These limits are designed to provide reasonable protection against harmful interference when the equipment is operated in a commercial environment. This equipment generates, uses, and can radiate radio frequency energy and, if not installed and used in accordance with the instruction manual, may cause harmful interference to radio communications. Operation of this equipment in a residential area is likely to cause harmful interference in which case the user will be required to correct the interference at his own expense.

Product Support: (715) 386-8666

Due to the dynamic nature of the product design, the information contained in this document is subject to change without notice. Viking Electronics, and its affiliates and/or subsidiaries assume no responsibility for errors and omissions contained in this information. Revisions of this document or new editions of it may be issued to incorporate such changes.