

SERIES HC25

Dynapar™ brand

Shafted Encoder

Key Features

- Optional Extended Temperature Range of -40° to $+85^{\circ}\text{C}$
- High 5000PPR Resolution Available
- Industry Standard Size 25 (2.5")



SPECIFICATIONS

STANDARD OPERATING CHARACTERISTICS

Code: Incremental

Resolution: 3000 to 5000 PPR (pulses/revolution)

Accuracy: (Worst case any edge to any other edge) $\pm 10.8^{\circ}/\text{PPR}$

Format: Two channel quadrature (AB) with optional Index (Z) and complementary outputs

Phase Sense: A leads B for CW or CCW shaft rotation as viewed from the shaft end of the encoder; see Ordering Information

Quadrature Phasing: $90^{\circ} \pm 25^{\circ}$ electrical

Symmetry: $180^{\circ} \pm 25^{\circ}$ electrical

Index: $90^{\circ} \pm 25^{\circ}$ electrical (gated with B low)

Waveforms: Squarewave with rise and fall times less than 1 microsecond into a load capacitance of 1000 pF

ELECTRICAL

Input Power:

4.5 min. to 26 VDC max. at 80 mA max., not including output loads

Outputs:

7273 Open Collector: 30 VDC max., 40 mA sink max.

7272 Push-Pull and Differential Line Driver: 40 mA sink or source

Frequency Response: 250 kHz

Electrical Protection: Overvoltage, reverse voltage and output short circuit protected

Noise Immunity: Tested to EN61326 (Industrial) for Electro Static Discharge, Radio Frequency Interference, Electrical Fast Transients, Conducted and Magnetic Interference

CONNECTIONS

Mating Connector:

7 pin, style MS3106A-16S-1S (MCN-N5);

10 pin, style MS3106A-18-1S (MCN-N6)

5 pin, style M12: Cable with connector available

8 pin, style M12: Cable with connector available

MECHANICAL

Shaft Loading: 40 lbs. radial, 30 lbs. axial

Shaft Speed: 10,000 RPM max. (See Frequency Response)

Starting Torque: (max at 25°C)

HC525: 1.0 oz-in;

HC625: 2.5 oz-in

Moment of Inertia: 2.83×10^{-4} oz-in-sec²

ENVIRONMENTAL

Operating Temperature:

Standard: 0 to $+70^{\circ}\text{C}$;

Extended: -40 to $+85^{\circ}\text{C}$

Storage Temperature: -40 to $+90^{\circ}\text{C}$

Shock: 50 G's for 11 milliseconds duration

Vibration: 5 to 2000 Hz at 20 G's

Humidity: to 98% without condensation

Enclosure Rating:

HC525: NEMA12/IP54 (dirt tight, splashproof);

HC625: NEMA4/IP66 (dust proof, washdown)

Ordering Information

To order, complete the model number with code numbers from the table below:

Code 1: Model	Code 2: PPR	Code 3: Mechanical	Code 4: Output	Code 5: Electrical	Code 6: Termination	Code 7: Options
HC <input type="checkbox"/> 25 <input type="checkbox"/> <input type="checkbox"/> <input type="checkbox"/> <input type="checkbox"/> <input type="checkbox"/> <input type="checkbox"/> <input type="checkbox"/> <input type="checkbox"/> <input type="checkbox"/>						

Ordering Information

HC525 Size 25 Enclosed, Shielded Bearings	3000 3,000 3600 3,600 4096 4,096 5000 5,000	0 Flange Mount, 3/8" Shaft	7 Pin Connector or Cable	0 5-26V in; 5-26V Open Collector with 2.2kΩ Pullup out	0 End Mount Connector	Blank None available when Code 4 is 0 thru G, and Code 6 is 0 or 1:
		1 2.50" Servo Mount/ 4 Hole, 2.00" BC Face Mount, 3/8" Shaft	0 Single Ended, no Index, Format A, Table 2	1 5-26V in; 5-26V Open Collector out	1 Side Mount Connector	
HC625 Size 25 Enclosed, with Shaft Seal		2 Flange Mount, 1/4" Shaft	1 Single Ended, with Index, Format A, Table 2	2 5-26V in; 5V Totem Pole out	Available when Code 1 is HC525: 2 18" Cable, Side 3 3' Cable, Side 4 6' Cable, Side 5 10' Cable, Side 6 15' Cable, Side J 18" Cable, End K 3' Cable, End L 6' Cable, End M 10' Cable, End N 15' Cable, End	PS LED Output Indicator
		3 2.50" Servo Mount/ 4 Hole 2.00" BC Face Mount, 1/4" Shaft	4 Single Ended, with Index, Format B, Table 2	3 5-26V in; 5V Line Driver out		
		4 2.50" Servo Mount/ 3 Hole, 2.00" BC Face Mount, 3/8" Shaft	6 Differential, no Index, Format C, Table 3	4 5-26V in; 5-26V Line Driver out		
		5 2.50" Servo Mount/ 3 Hole, 2.00" BC Face Mount, 1/4" Shaft	A Single Ended, with Index, Format C, Table 2	A Same as "0" with extend. temp range		
		6 2.50" Servo Mount/ 3 Hole, 1.88" BC Face Mount, 3/8" Shaft	C Single Ended, no Index, Format C, Table 2	B Same as "1" with extend. temp range		
		7 2.50" Servo Mount/ 3 Hole, 2.00" BC Face Mount, 1/4" Shaft	G Single Ended, with Index, Format D, Table 2	C Same as "2" with extend. temp range		
		8 2.62" Servo Mount/ 3 Hole, 1.88" BC Face Mount, 3/8" Shaft	10 Pin Connector or Cable	D Same as "3" with extend. temp range		
		9 2.62" Servo Mount/ 3 Hole, 1.88" BC Face Mount, 1/4" Shaft	2 Differential, no Index, Format A, Table 1	E Same as "4" with extend. temp range		
			3 Differential, with Index, Format A, Table 1			
			5 Differential, with Index Format B, Table 1			
	B Differential, with Index Format C, Table 1					
	D Differential, no Index, Format C, Table 1					
	5 Pin M12 Connector					
	H Single ended, no index, Format A, Table 4					
	J Single ended, with index, Format A, Table 4					
	K Single ended, with index, Format B, Table 4					
	L Single ended, with index, Format C, Table 4					
	M Single ended, no index, Format C, Table 4					
	N Single ended, with index, Format D, Table 4					
	8 Pin M12 Connector					
	P Single ended, no index, Format A, Table 5					
	Q Single ended, with index, Format A, Table 5					
	R Single ended, with index, Format B, Table 5					
	S Single ended, with index, Format C, Table 5					
	T Single ended, no index, Format C, Table 5					
	U Single ended, with index, Format D, Table 5					
	V Differential, no index, Format A, Table 6					
	W Differential, with index, Format A, Table 6					
	X Differential, with index, Format B, Table 6					
	Y Differential, with index, Format C, Table 6					
	Z Differential, no index, Format C, Table 6					

10 foot Cable Assemblies with MS Connector

- 1400431-0010** 7 Pin MS, Cable Assy. For Use with Single Ended w/Index Outputs
- 108596-0010** 7 Pin MS, Cable Assy. For Use with Differential Line Driver w/o Index Outputs
- 1400635-0010** 10 Pin MS, Cable Assy. For Use with Differential Line Driver with Index Outputs

15 foot Cable Assemblies with M12 Connector

- 112859-0015** 5 Pin M12, Cable Assy. For Use with Single Ended Outputs
- 112860-0015** 8 Pin M12, Cable Assy. For Use with Single Ended Outputs
- 112860-0015** 8 Pin M12, Cable Assy. For Use with Differential Line Driver Outputs

SERIES HC25



ELECTRICAL CONNECTIONS

Prewired Cable or Accessory Cables with 7 or 10 Pin MS Connector - when Code 4= 0 to 6, or A, B, C, D or G

Note: Wire color codes are referenced here for models that are specified with pre-wired cable. Connector/cables are described in the Encoder Accessories section of this catalog and color-coding information is provided here for reference.

Pin	Function (If Used)	Wire Color Code	Cable* Accessory Color Code
A	Signal A	BRN	BRN
B	Signal B	ORN	ORN
C	Signal Z	YEL	YEL
D	Power Source	RED	RED
E	No Connection	—	—
F	Common	BLK	BLK
G	Case	GRN	GRN
H	Signal \bar{A}	BRN/WH	BRN/WH
I	Signal \bar{B}	ORN/WH	ORN/WH
J	Signal \bar{Z}	YEL/WH	YEL/WH

*Cable Accessory: P/N 14006350010

Pin	Function (If Used)	Wire Color Code	Cable* Accessory Color Code
A	Signal A	BRN	RED
B	Signal B	ORN	BLUE
C	Signal Z	YEL	YEL
D	Power Source	RED	WHT
E	No Connection	—	GRN
F	Common	BLK	BLK
G	Case	GRN	SHIELD

*Cable Accessory: P/N 14004310010

Pin	Function (If Used)	Cable Accessory Color Code
A	Signal A	BRN
B	Signal B	ORN
C	Signal \bar{A}	BRN/WHT
D	Power Source	RED
E	Signal B	ORN/WHT
F	Common	BLK
G	Case	GRN

*Cable Accessory: P/N 1085960010

Cable Configuration: PVC jacket, 105 °C rated, overall foil shield; 3 twisted pairs 26 AWG (output signals), plus 2 twisted pairs 24 AWG (input power)

5 & 8 Pin M12 Accessory Cables - when Code 4= H to Z

Connector pin numbers and cable assembly wire color information is provided here for reference.

Encoder Function	Table 4 5 Pin Single Ended		Table 5 8 Pin Single Ended		Table 6 8 Pin Differential	
	Pin	Wire Color	Pin	Wire Color	Pin	Wire Color
Sig. A	4	BLK	1	BRN	1	BRN
Sig. B	2	WHT2	4	ORG	4	ORG
*Sig. Z	5	GRY	6	YEL	6	YEL
Power +V	1	BRN	2	RED	2	RED
Com	3	BLU	7	BLK	7	BLK
Sig. \bar{A}	—	—	—	—	3	BRN/WHT
Sig. \bar{B}	—	—	—	—	5	ORG/WHT
*Sig. \bar{Z}	—	—	—	—	8	YEL/WHT

* Index not provided on all models. See ordering information

Cable Configuration: PVC jacket, 105 °C rated, overall foil shield; 24 AWG conductors, minimum

See “Accessories” Section for Connectors and Cable Assemblies Ordering Information

DIMENSIONS

Code 3: Mechanical

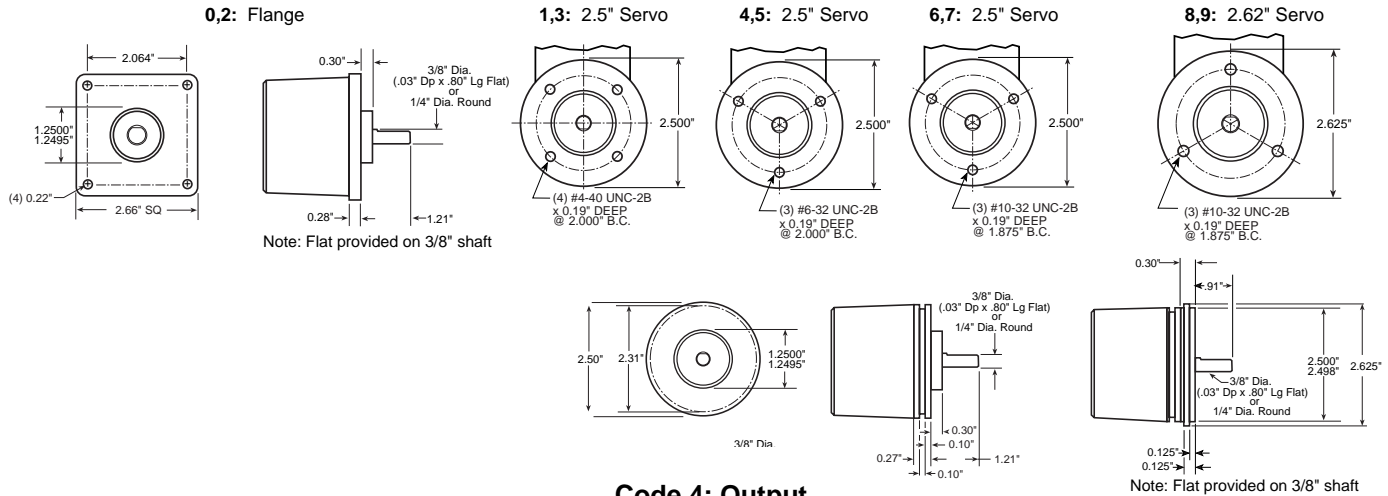

0 - 3: Format A

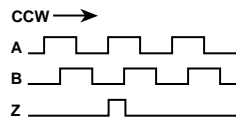

4,5: Format B

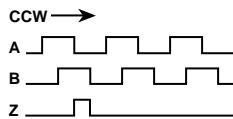

6 - D: Format C

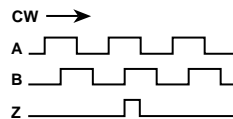

G: Format D

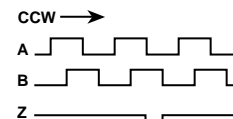

Code 6: Termination

0: End MS Connector 1: Side MS Connector
 When Code 5 is 0 to 6 or A to G

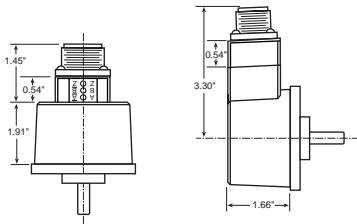

0: End M12 Connector 1: Side M12 Connector
 When Code 5 is H to Z

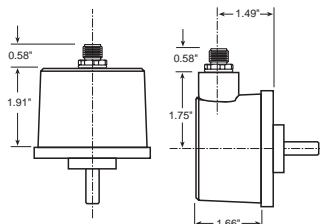

2 - 6: Side Cable

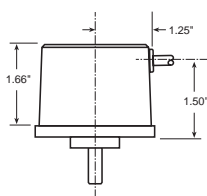

J - N: End Cable

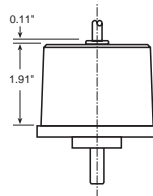

A - F: Side W.T. Cable P - T: End W.T. Cable

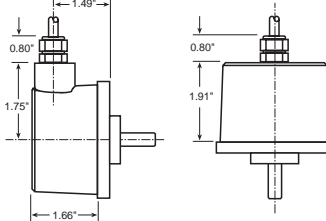

Worldwide Brands: NorthStar™ • Acuro™ • Dynapar™ • Hengstler™ • Harowe™
 Headquarters: 1675 Delany Road • Gurnee, IL 60031-1282 • USA • Phone: 1.847.662.2666 • Fax: 1.847.662.6633

Satellite Locations:

- **North America:** North Carolina, South Carolina, Connecticut, Massachusetts, New York, Canada, British Virgin Islands
- **West Indies:** St. Kitts • **Europe:** United Kingdom, Italy, France, Germany, Spain, Slovakia
- **South America:** Brazil • **Asia:** China, Japan, Korea, Singapore

Customer Service:

Tel.: +1.800.873.8731
 Fax: +1.847.662.4150
 custserv@dynapar.com

Technical Support

Tel.: +1.800.234.8731
 Fax: +1.847.782.5277
 dynapar.techsupport@dynapar.com
 northstar.techsupport@dynapar.com

European Sales Representative

Hengstler GmbH
 Uhlandstrasse 49, 78554 Aldingen
 Germany
 www.hengstler.de