

OSR03-SERIES

DC-DC CONVERTER

2.5VDC~30VDC WIDE INPUT RANGE
UP TO 45Watts

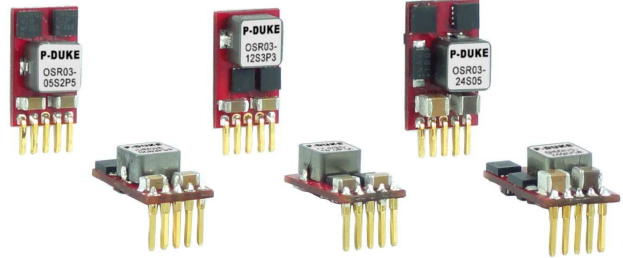

FEATURES

- SMALL SIZE AND LOW PROFILE : 0.37 X 0.24 X 0.61; 0.41 X 0.24 X 0.65 INCH
- OPEN FRAME PACKAGES
- NEGATIVE OUTPUT APPLICATION
- REMOTE ON/OFF
- ADJUSTABLE OUTPUT VLOTAGE
- SHORT CIRCUIT PROTECTION
- OVER-TEMPERATURE PROTECTION
- SAFETY MEETS UL60950-1, EN60950-1, & IEC60950-1
- CE MARKED
- COMPLIANT TO RoHS II & REACH

APPLICATIONS

- WIRELESS NETWORK
- TELECOM/DATACOM
- INDUSTRY CONTROL SYSTEM
- DISTRIBUTED POWER ARCHITECTURES
- SEMICONDUCTOR EQUIPMENT

NON ISOLATION	REMOTE CONTROL	OCP	SCP	OTP
---------------	----------------	-----	-----	-----

TECHNICAL SPECIFICATION All specifications are typical at nominal input, full load and 25°C otherwise noted

Positive output application

Model Number	Input Range VDC	Output Voltage VDC	Output Current @FullLoad A	Input Current @ No Load mA	Efficiency %	Maximum Capacitor Load	
						ESR ≥ 1mΩ	ESR ≥ 10mΩ
						μF	
OSR03-05S2P5	2.5 ~ 5.5	0.6 ~ 3.3	3	20	95.0@2.5Vo	1000	3000
OSR03-12S3P3	4.5 ~ 14	0.59 ~ 6.0	3	25	93.0@3.3Vo	1000	3000
OSR03-24S05	10 ~ 30	3.0 ~ 6.0	3	25	91.0@5.0Vo	1000	3000
OSR03-24S12	10 ~ 30	5.0 ~ 15	3	30	95.0@12Vo	500	1200

Negative output application

Model Number	Input Range VDC	Output Voltage VDC	Output Current ⁽²⁾ @FullLoad A	Input Current @ No Load mA	Efficiency %	Maximum Capacitor Load
						μF
						OSR03-12S3P3
OSR03-24S05	10 ~ 27	-3.0 ~ -6.0	-2.2	35	90.0@-5.0Vo	2200
OSR03-24S12	10 ~ 25	-5.0 ~ -15	-1.2	60	91.0@-12Vo	580

*Please see page 2 input specifications for input range details.

PART NUMBER STRUCTURE

OSR03	-	24	S	05	A
Series Name		Input Voltage (VDC)	Output Quantity	Output Voltage (VDC)	Assembly Option
Positive		05: 2.5~5.5 12: 4.5~14 24: 10~ 30	S: Single	2P5: 0.6~ 3.3 3P3: 0.59~6.0 05: 3.0~6.0 12: 5.0~15	□:Standard A:Horizontal type
Negative		05: 4.7~13 12: 10~ 27 24: 10~ 25		3P3: -0.59~ -6.0 05: -3.0~ -6.0 12: -5.0~ -15	

INPUT SPECIFICATIONS

Parameter	Conditions	Min.	Typ.	Max.	Unit
Operating input voltage range ⁽³⁾	Positive output application 05S2P5 (Vin>Vo+0.5V) 05Vin(nom), 0.6 ~ 3.3Vout 12S3P3 (Vin>Vo+2.0V) 12Vin(nom), 0.59 ~ 6.0Vout 24S05 (Vin>Vo+3.0V) 24Vin(nom), 3.0 ~ 6.0Vout 24S12 (Vin>Vo+3.0V) 24Vin(nom), 5.0 ~ 15Vout	2.5 4.5 10 10		5.5 14 30 30	VDC
	Negative output application 12S3P3 (Vin.max=14- Vo) 12Vin(nom), -0.59 ~ -6.0Vout 24S05 (Vin.max=30- Vo) 12Vin(nom), -3.0 ~ -6.0Vout 24S12 (Vin.max=30- Vo) 12Vin(nom), -5.0 ~ -15Vout	4.7 10 10		13 27 25	VDC
Input reflected ripple current	To minimize input reflected ripple. External π filter is recommended at the input of the module. See datasheet.		30		mAp-p
Maximum input current	05S2P5			3.0	A
	12S3P3			2.6	
	24S05			2.2	
	24S12			3.0	
Input filter			Capacitor type		

OUTPUT SPECIFICATIONS

Parameter	Conditions	Min.	Typ.	Max.	Unit	
Voltage accuracy		-2.0		+2.0	%	
Line regulation	$V_o \geq 2.5V$		0.2		%	
	$V_o < 2.5V$		5		mV	
Load regulation	0% to 100% of F.L.	$V_o \geq 2.5V$	0.8		%	
		$V_o < 2.5V$	20		mV	
	10% to 90% of F.L.	$V_o \geq 2.5V$	0.6		%	
		$V_o < 2.5V$	15		mV	
Ripple and noise	Positive output application Measured by 20MHz bandwidth	05S2P5 12S3P3	30 60		mVp-p	
	With a 2.2 μ F MLCC	24S05	75			
	With a 2.2 μ F MLCC	24S12	150			
	Negative output application (In Figure 1)	12S3P3	60		mVp-p	
	With a C1=10 μ F/50V MLCC and a	24S05	75			
	C2=10 μ F/25V MLCC	24S12	150			
Temperature coefficient		-1		+1	%/°C	
Dynamic load response	50% load step change	Peak deviation Others	150		mV	
		Peak deviation 24S12	250		mV	
		Recovery time	120		μ s	
Over load protection	% of Iout rated; Hiccup mode	05S2P5	280		%	
		12S3P3 : 24S05 : 24S12	220			
Short circuit protection		Continuous, automatics recovery				
Output voltage overshoot-startup				1	%	
Voltage adjustability ⁽¹⁾	(See Figure 2)	05S2P5	0.6		3.3	VDC
		12S3P3	0.59		6	
		24S05	3		6	
		24S12	5		15	

FEATURE SPECIFICATIONS

Parameter	Conditions	Min.	Typ.	Max.	Unit
Rise time	Time for Vo to rise from 10% to 90% Vo	05S2P5 : 12S3P3 24S05 : 24S12		6 10	ms
Remote on/off	The ON/OFF control pin voltage is referenced to GND (Positive logic)	05S2P5 Others		ON = Open or Vin(max) OFF=0V < Vr < 0.3V ON = 1V < Vr < 12V OFF=0V < Vr < 0.3V	

GENERAL SPECIFICATIONS

Parameter	Conditions	Min.	Typ.	Max.	Unit
Switching frequency	05S2P5 : 12S3P3 24S05 : 24S12	540 270	600 300	660 330	kHz
Safety meets					UL60950-1 EN60950-1 IEC60950-1
Case material					Open frame
Potting material					None
Weight	05S2P5 : 12S3P3 24S05 : 24S12				1.7g(0.060oz) 2.1g(0.074oz)
MTBF	MIL-HDBK-217F, Full load				4.467 x 10 ⁶ hrs

ENVIRONMENTAL SPECIFICATIONS

Parameter	Conditions	Min.	Typ.	Max.	Unit
Operating temperature range		-40		+85	°C
Over temperature protection	Internal IC junction		+150		°C
Storage temperature range		-55		+125	°C
Thermal shock					MIL-STD-810F

Note:

- Output voltage can be adjusted by connecting a single resistor between the TRIM and GND pins of the module. To calculate the value of the resistor **Rtrim** for a particular output voltage **Vo**, use the following equation: in **Table1**
- OSR03-12S3P3: When use negative output application and |Vo| trim up >3.3V, the Output Current maximum is 1.5A
- OSR03-12S3P3 : When Vo,set < 0.9V, the input voltage range is 4.5V to 9V.

CAUTION: This power module is not internally fused. An input line fuse must always be used.

CHARACTERISTIC CURVE

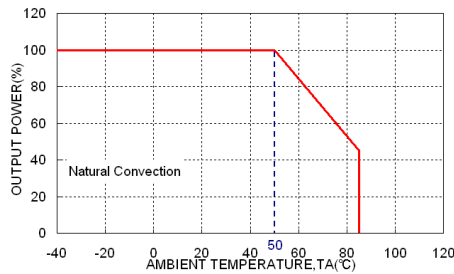

OSR03-12S3P3 Derating Curve
Positive output application

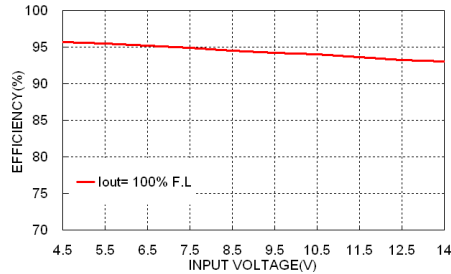

OSR03-12S3P3 Efficiency vs. Input Voltage
Positive output application

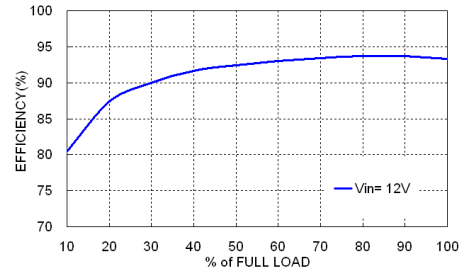

OSR03-12S3P3 Efficiency vs. Output Load
Positive output application

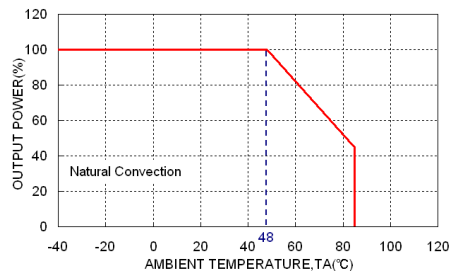

OSR03-12S3P3 Derating Curve
Negative output application

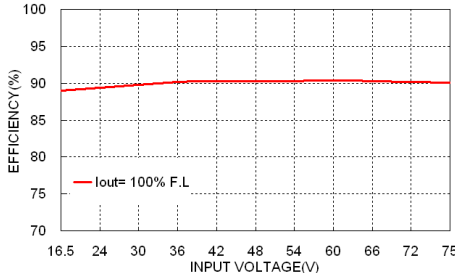

OSR03-12S3P3 Efficiency vs. Input Voltage
Negative output application

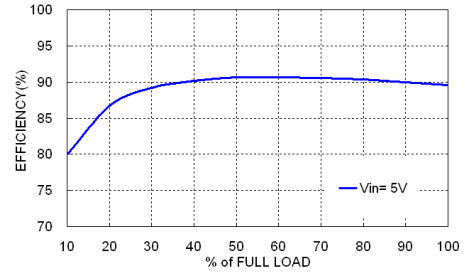

OSR03-12S3P3 Efficiency vs. Output Load
Negative output application

NEGATIVE OUTPUT APPLICATION

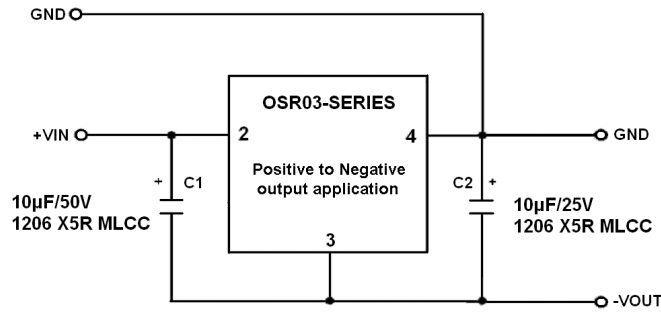

Figure 1

C1 and C2 are required and should be fitted close to the converter pins.

TRIM APPLICATION

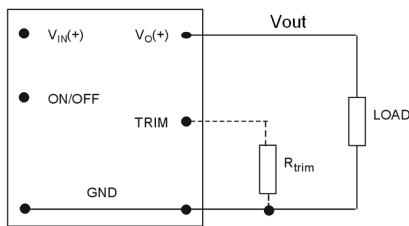

Figure 2

Model Name	R _{trim_up} (kΩ)
OSR03-05S2P5	$\frac{1.2}{V_o - 0.6} - 0.01$
OSR03-12S3P3	$\frac{1.18}{V_o - 0.59}$
OSR03-24S05	$\frac{11.2}{V_o - 3}$
OSR03-24S12	$\frac{8.4}{V_o - 5}$

Table 1

MECHANICAL DRAWING FOR STARDANDS

OSR03-05S2P5

suffix A

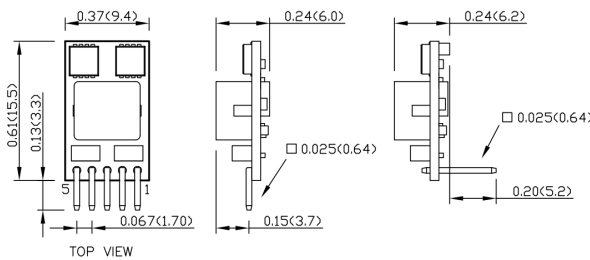

OSR03-12S3P3

suffix A

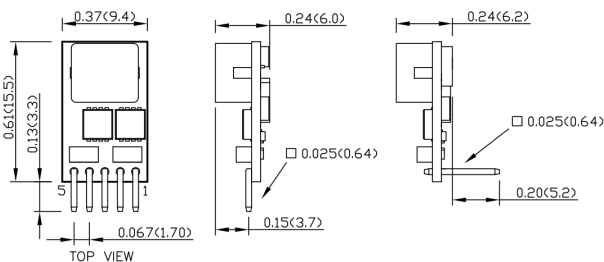

OSR03-24S05/OSR03-24S12

suffix A

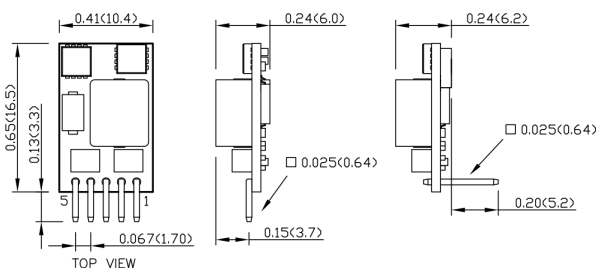

PIN CONNECTION

PIN	DEFINE
1	Ctrl
2	+Vin
3	GND
4	+Vout
5	Trim

- All dimensions in inch (mm)
- Tolerance :x.xx±0.02 (x.x±0.5)
x.xxx±0.01 (x.xx±0.25)
- Pin pitch tolerance ±0.01 (0.25)
- Pin dimension tolerance ±0.004(0.1)