

### APPLICATIONS

Wireless Network  
Telecom/Datacom  
Industry Control System  
Distributed Power Architectures  
Semiconductor Equipment  
Microprocessor Power Applications

### FEATURES

- OUTPUT CURRENT UP TO 10A
- SMALL SIZE AND LOW PROFILE :  
1.30" X 0.53" X 0.30" (SMD) ; 2.00" X 0.50" X 0.28" (SIP)
- HIGH EFFICIENCY UP TO 95% @ 3.3V FULL LOAD
- INPUT RANGE FROM 2.4VDC TO 5.5VDC
- FIXED SWITCHING FREQUENCY (300kHz)
- SMD & SIP PACKAGES
- SMD PACKAGE QUALIFIED FOR LEADFREE REFLOW SOLDER PROCESS ACCORDING IPC J-STD-020D
- OUTPUT VOLTAGE PROGRAMMABLE FROM 0.75VDC TO 3.3VDC VIA EXTERNAL RESISTOR
- INPUT UNDER-VOLTAGE PROTECTION
- UL60950-1, EN60950-1, & IEC60950-1 SAFETY APPROVALS
- CE MARKED
- COMPLIANT TO RoHS II & REACH

### OPTIONS

POSITIVE LOGIC REMOTE ON/OFF

### DESCRIPTION

DOS10-05T (SMD type), DOH10-05T (for Vertical Mounting SIP type) and DOH10-05TA (for Horizontal Mounting SIP type) are non-isolated DC/DC converters that can deliver up to 10A of output current with full load efficiency of 95% at 3.3V output.

## TECHNICAL SPECIFICATION

All specifications are typical at nominal input, full load and 25°C otherwise noted

OUTPUT SPECIFICATIONS	
Output current	10A max
Voltage accuracy	± 2%Vout(set)
Minimum load	0%
Line regulation	$V_{in}=V_{out(set)}+0.5V$ to $V_{in(max)}$ at Full Load      ± 0.3%Vout(set)
Load regulation	No Load to Full Load      ± 0.4%Vout(set)
Ripple and noise (Note2)	20MHz bandwidth      15mVrms,max 50mVp-p,max
Temperature coefficient	±0.4%
Dynamic load response (Note 2)	$\Delta I_o / \Delta t = 2.5A/\mu s$ , $V_{in(nom)}$ Peak deviation      200mV Load change step (50% to 100% or 100% to 50% of $I_o(max)$ )      Setting time ( $V_{out}<10\%$ peak deviation)      25μs
	$\Delta I_o / \Delta t = 2.5A/\mu s$ , $V_{in(nom)}$ Peak deviation      100mV Load change step (50% to 100% or 100% to 50% of $I_o(max)$ )      Setting time ( $V_{out}<10\%$ peak deviation)      100μs
Output current limit	200%
Output short-circuit current	Continuous, automatic recovery
External load capacitance	$ESR \geq 1m\Omega$ 1000μF,max
	$ESR \geq 10m\Omega$ 5000μF,max
Output voltage overshoot-startup	$V_{in}=2.4 \sim 5.5V$ , F.L.      1%Vout(set)
Voltage adjustability (see fig.1)	(Note 4)      0.7525V ~ 3.63V
GENERAL SPECIFICATIONS	
Efficiency	See table
Isolation voltage	None
Switching frequency	300kHz±10%
Safety approvals	IEC60950-1, UL60950-1, & EN60950-1
Dimensions	SMD      1.30 X 0.53 X 0.30 Inch (33.0 X 13.5 X 7.7 mm)
	SIP      2.00 X 0.50 X 0.28 Inch (50.8 X 12.7 X 7.2 mm)
Weight	6.0g(0.22oz)
MTBF (Note 1)	MIL-HDBK-217F      3.239 x 10 <sup>6</sup> hrs

INPUT SPECIFICATIONS	
Input voltage range	$V_{out(set)} < V_{in} - 0.5V$ 2.4 ~ 5.5VDC
Maximum input current	$V_{in}=2.4$ to 5.5V; $I_o=I_o(max)$ 10A
Input filter (Note 5)	C filter
Input no load current ( $V_{in}=5V$ , $I_o=0$ , module enabled)	$V_{out(set)} = 0.75VDC$ 100mA
	$V_{out(set)} = 3.3VDC$ 130mA
Input under voltage lockout	Start-up voltage      2.2VDC
	Shutdown voltage      2.0VDC
Input reflected ripple current	5~20MHz, 1μH source impedance      100mA p-p
ENVIRONMENTAL SPECIFICATIONS	
Operating ambient temperature	-40°C ~ +85°C(with derating)
Storage temperature range	-55°C ~ +125°C
Thermal shock	MIL-STD-810F
Vibration	MIL-STD-810F
Relative humidity(non-condensing)	5% ~ 95% RH
Lead-free reflow solder process	IPC J-STD-020D
Moisture sensitivity level(MSL)	IPC J-STD-033B Level 2a
Over temperature protection	125°C
FEATURE SPECIFICATIONS	
Remote ON/OFF(Note 6) (Negative logic)(standard)	ON = Open or $0V < V_r < 0.3V$ $I_{IN}=10\mu A,max$
	OFF = $1.5V < V_r < V_{in(max)}$ $I_{IN}=1mA,max$
(Positive logic)(option)	ON = Open or $V_{in(max)}$ $I_{IN}=10\mu A,max$
	OFF = $0V < V_r < 0.3V$ $I_{IN}=1mA,max$
Input current of Remote control pin	10μA~1.0mA
Remote off state input current	Nominal Input      1.5mA,typ
Remote sense range	0.5V,max
Rise time	Time for $V_{out}$ to rise from 10% to 90%of $V_{out(set)}$ 6mS, max.
Turn-on delay time	Case 1 (Note7)      1ms
	Case 2 (Note8)      1ms

Model Name	ON/OFF Logic	Package	Input Voltage	Output Voltage	Output Current		Efficiency (%) 5.0Vin, 3.3VDC@10A
					Min. Load	Max. Load	
DOS10-05T	Negative	SMD	2.4 ~ 5.5VDC Vin(min)=Vout(set)+0.5V	0.75 ~ 3.3VDC	0A	10A	95%
DOS10-05T-P	Positive						
DOH10-05T	Negative	Vertical Mounting SIP					
DOH10-05T-P	Positive						
DOH10-05TA	Negative	Horizontal Mounting SIP					
DOH10-05TA-P	Positive						

**Note**

- MIL-HDBK-217F @Ta=25 °C, Full load.
- External with C<sub>out</sub> = 1μF ceramic//10μF tantalum capacitors.
- External with C<sub>out</sub> = 2pcs of 150μF polymer capacitors.
- Output voltage programmable from 0.75V to 3.3V by connecting a single resistor (shown as R<sub>trim</sub> in Table 1) between the TRIM and GND pins of the module. To calculate the value of the resistor **R<sub>trim</sub>** for a particular output voltage **V<sub>out</sub>**, use the following equation:

$$R_{trim} = \left[ \frac{21070}{V_{out} - 0.7525} - 5110 \right] \Omega$$

- It's necessary to equip the external input capacitors at the input of the module. The capacitors should connect as close as possible to the input terminals that ensuring module stability. The external C<sub>in</sub> is 3pcs of 150μF low-ESR polymer capacitors // 2pcs of 47μF ceramic capacitors at least.
- Device code with suffix "-P" – Positive logic(ON/OFF is open collector/drain logic input; Signal referenced to GND )  
Device code with no suffix – Negative logic (ON/OFF pin is open collector/drain logic input with external pull –up resistor; signal referenced to GND)
- Case 1 :On/Off input is set to logic low (module on) and then input power is applied (delay from instant at which Vin=Vin(min) until Vout=10% of Vout(set))
- Case 2 :Input power is applied for at least one second and then the ON/OFF input is set to logic low (delay form instant at which Von/off=0.3V until Vout=10% of Vout(set))

**CAUTION:** This power module is not internally fused. An input line fuse must always be used.

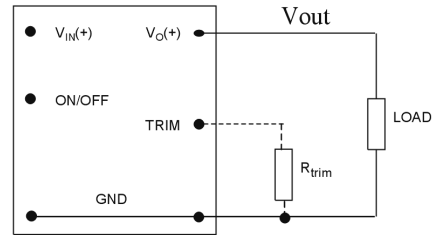
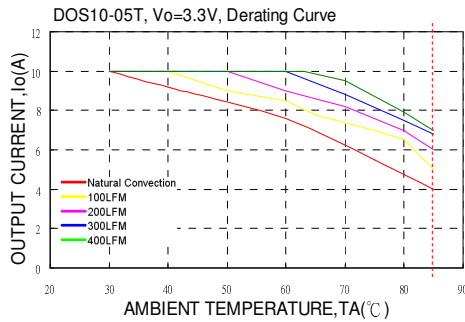
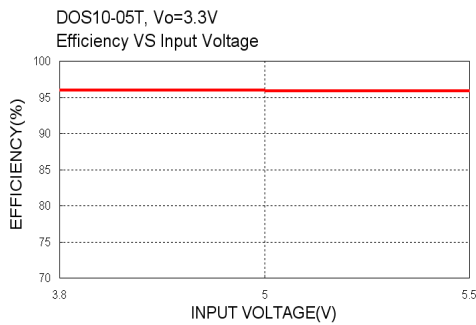
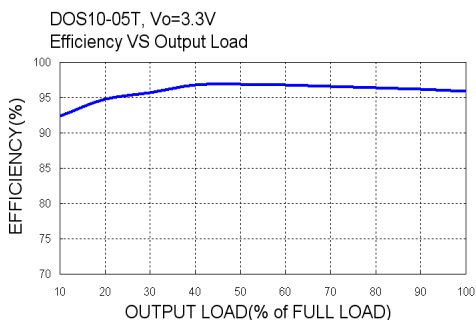

Fig. 1



Vout(set) (V)	Rtrim (KΩ)
0.7525	Open
1.2	41.973
1.5	23.077
1.8	15.004
2.5	6.974
3.3	3.160



**MECHANICAL DRAWING :**

**DOH10-05T TYPE**

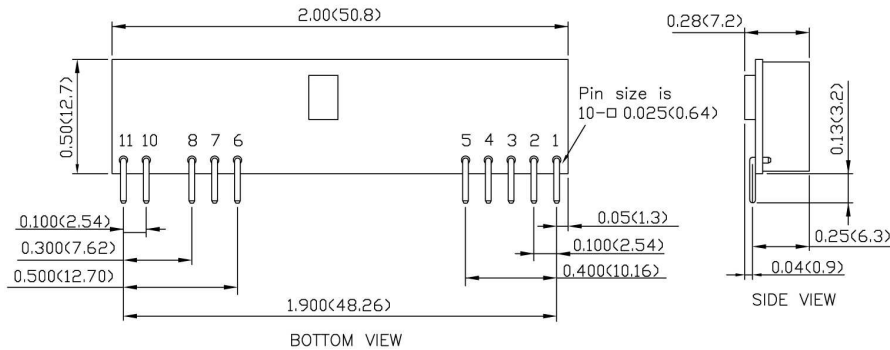

PIN CONNECTION	
PIN	DEFINE
1	+OUTPUT
2	+OUTPUT
3	+SENSE
4	+OUTPUT
5	GND
6	GND
7	+ INPUT
8	+ INPUT
10	TRIM
11	CTRL

**DOH10-05TA TYPE**

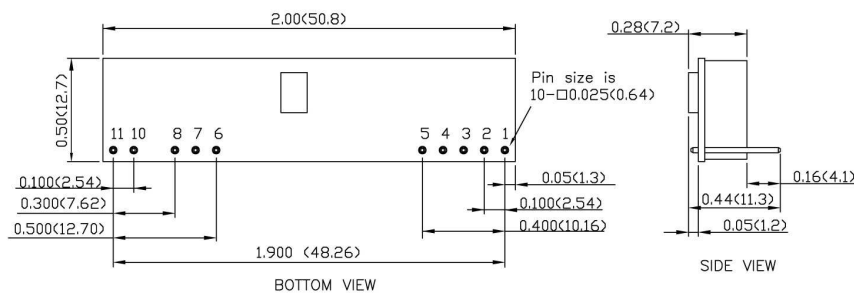

PIN CONNECTION	
PIN	DEFINE
1	+OUTPUT
2	+OUTPUT
3	+SENSE
4	+OUTPUT
5	GND
6	GND
7	+ INPUT
8	+ INPUT
10	TRIM
11	CTRL

**DOS10-05T TYPE**

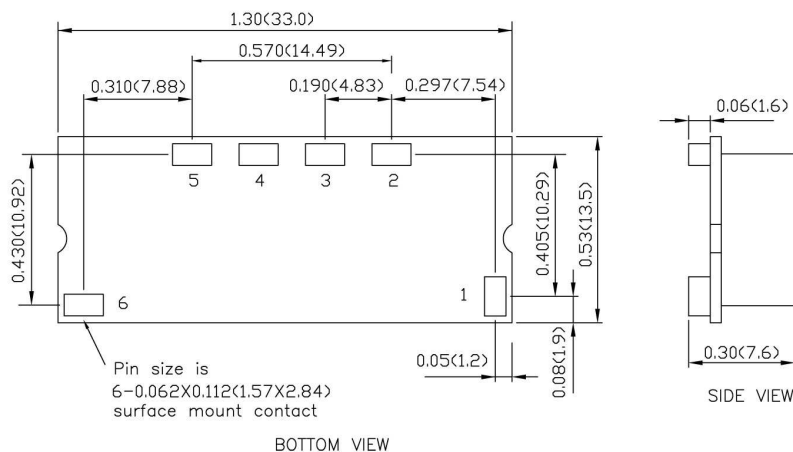

PIN CONNECTION	
PIN	DEFINE
1	CTRL
2	+SENSE
3	TRIM
4	+OUTPUT
5	GND
6	+ INPUT

- All dimensions in Inch (mm)  
Tolerance: X.XX±0.02 (X.X±0.5)  
X.XXX±0.01 (X.XX±0.25)
- Pin pitch tolerance ±0.01 (0.25)
- Pin dimension tolerance ±0.004 (0.1)