

CDS12-10000 potentiometric output – Measurement range 0 up to 10 000 mm

Specifications:

Measurement range	0 up to 10 000 mm
Output signal	1kΩ (other values on demand)
Resolution	Quasi infinite (depends on the operating system)
Material	Body and cover - Aluminium (RohS) Measuring cable - Stainless steel
Cable diameter	0,90 mm
Detection element	Precision potentiometer
Connection	Male connector M16 - DIN 3 pin Male connector M12 - 4 pin PVC cable - 4 wires
Standard linearity	+/- 0,15% f.s. +/- 0,10% f.s. (optional)
Protection class	IP65
Max. Velocity	10 m/s
Max. Acceleration	5 m/s² (before cable deformation)
Weight	≈ 6 kg
Operating temperature	-20° to +80°C
Storage temperature	-30° to +80°C



Cable forces:

Measurement range in mm	Min. pull-out force	Max. pull-out force
10 000	≈ 10,50 N	≈ 15,00 N

Ordering reference:

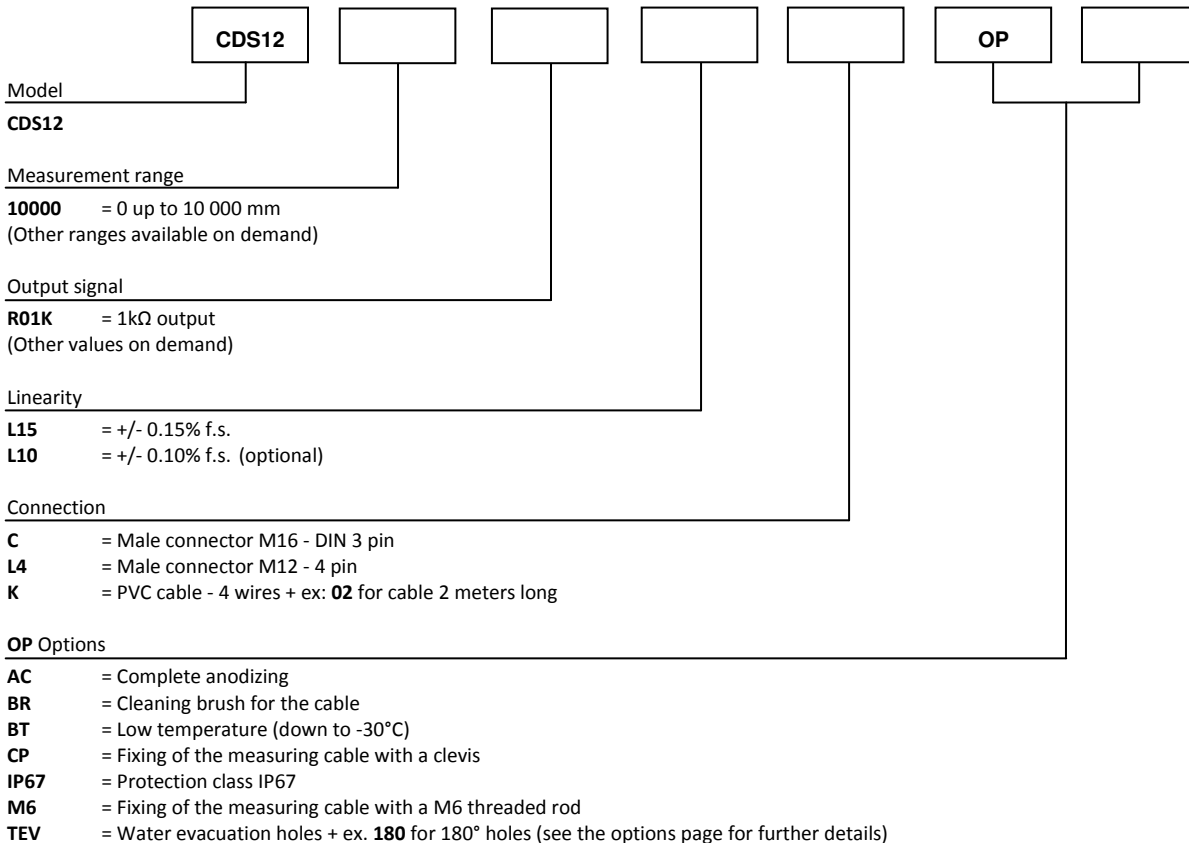

Reference example: CDS12-10000-R01K-L15-K02-OP-AC-M6

Made in France

CDS12-10000 potentiometric output – Measurement range 0 up to 10 000 mm



Dimensions:

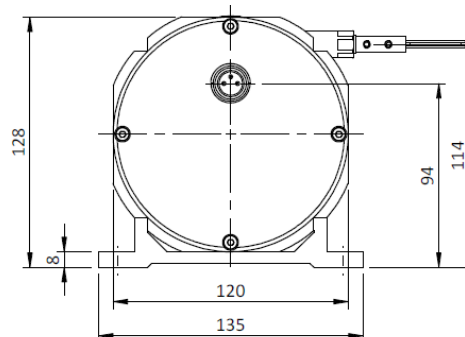
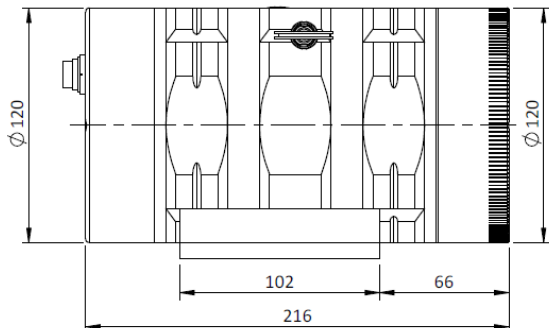

K connection
(PVC cable - 4 wires)

L4 connection
(connector M12 - 4 pin)

C connection
(Connector M16 - DIN 3 pin)

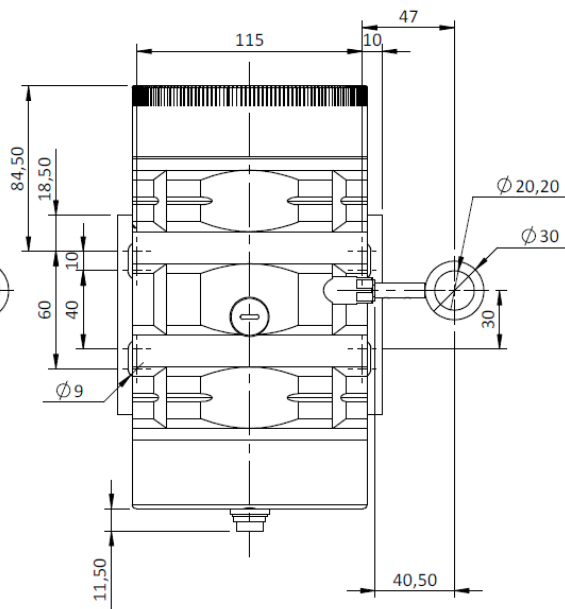
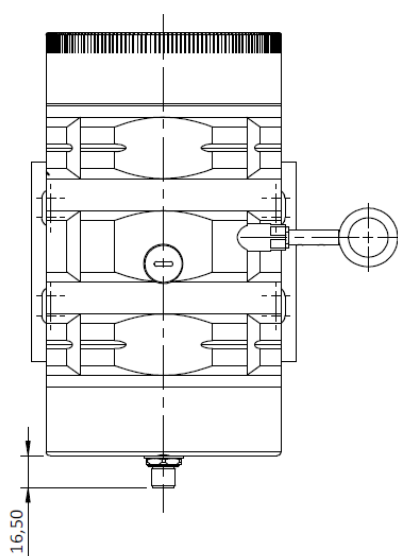
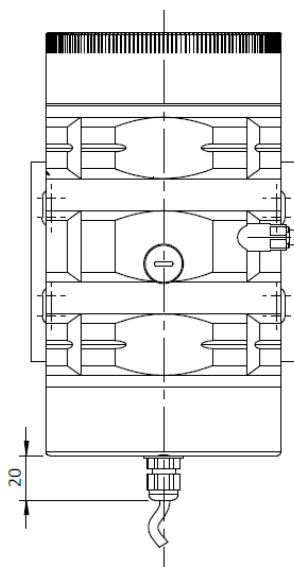

Modular base plate

