

ATEX ABSOLUTE SSI MULTI TURN ENCODER, PAUX RANGE

ATEX certified Explosion-proof encoders according to Directive 94/9/CE

Explosion-proof rotary encoders for hazardous environments gas & dust
Robust design for heavy-duty applications
Hollow through shaft up to 30mm
Application fields: explosive atmospheres except for firedamp mines

EC type examination certificate

Download from our website www.beisensors.com

ICIE03 ATEX 6407

CE0081

II 2 G/D

Ex d IIC T6, T5, T4

Ex tD A21 IP6X T80°C T95°C T100°C



PAUX_30 connection S5R (radial cable)

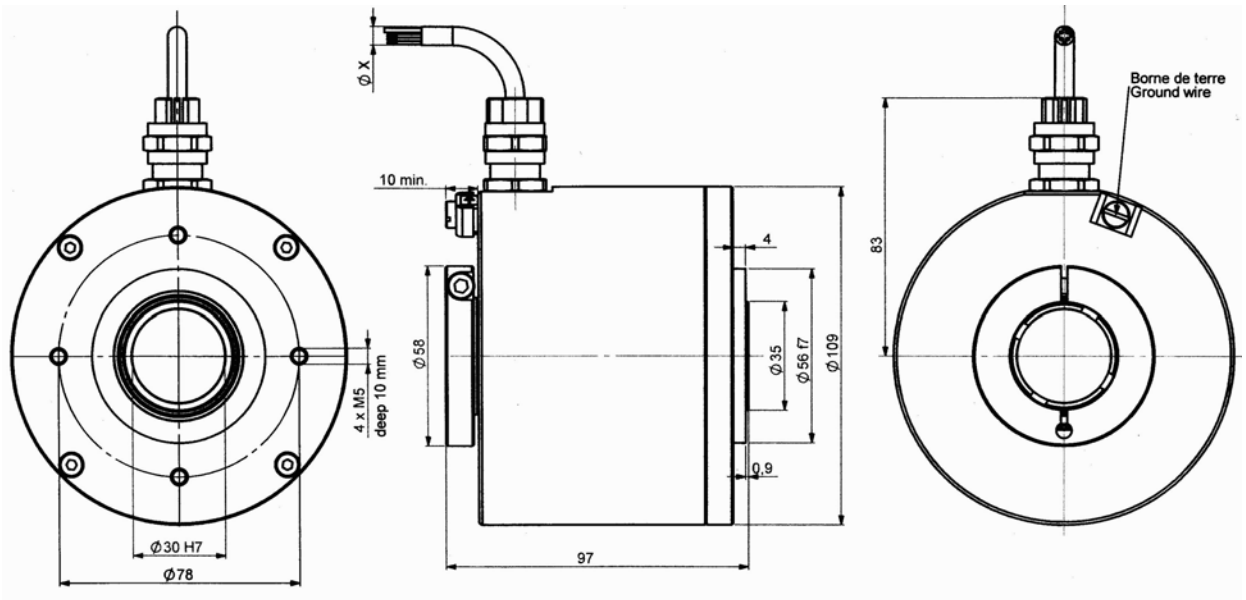

Material	Cover: aluminium
Stainless steel option	Body: aluminium
Shaft	Stainless steel
Bearings	6807 serie
Maximal load	Axial : 50 N
	Radial : 80 N
Shaft Inertia	$\leq 50 \cdot 10^{-6}$ kg.m ²
Torque	$\leq 25 \cdot 10^{-3}$ N.m
Permissible max. speed	4 500 min ⁻¹
Continuous max speed	3 000 min ⁻¹
Shaft seal	Viton
Shock (EN60068-2-27)	≤ 300 m.s ⁻² (during 6 ms)

Vibration (EN60068-2-6)	≤ 100 m.s ⁻² (10 ... 500 Hz)
EMC	EN 50081-1, EN 61000-6-2
Isolation	500 V eff
Weight	2kg aluminium body & cover
	5kg stainless steel body & cover
Operating temperature	Cf here-under table (encoder T°)
Storage temperature	- 10... + 70 °C
Protection (EN 60529)	IP 65
Torque (ring pressure screw)	nominal: 3N.m, break: 4N.m
Theoretical mechanical lifetime 10 ⁹ turns (F _{axial} / F _{radial})	
25 N / 40 N	140
50 N / 80 N	17

T _{amb}	Temperature class for gas atmosphere	Temperature class for dust atmosphere
-20°C ≤ T _a ≤ +40°C	T6	T80°C
-20°C ≤ T _a ≤ +55°C	T5	T95°C
-20°C ≤ T _a ≤ +60°C	T4	T100°C



ATEX ABSOLUTE SSI MULTI TURN ENCODER, PAUX RANGE

ELECTRICAL CHARACTERISTIC

Input signal clock CLK	per opto-coupler	Power supply	5 – 30Vdc
Output signal DATA	line - driver RS422	Introduction	< 1 s
Clock frequency CLK	100kHz – 500kHz	Cons. without load	< 100mA (typically 50-60mA at 24Vdc)
Precision	± ½ LSB (13 bits)	Position refresh	< 200µs

SSI TRANSMISSION

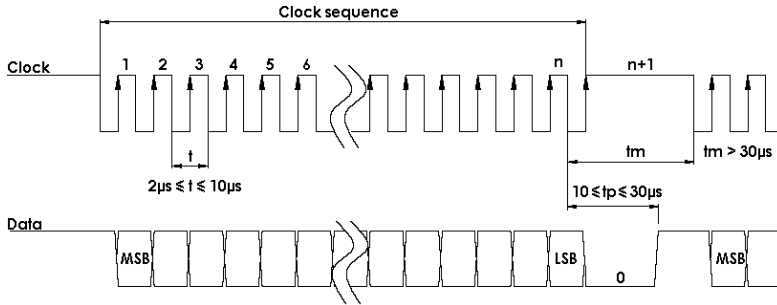

Transmission	Transmission up to 400m* at 100kHz in function of the cable characteristics
Cable	High security of transmission by using shielded cable and twisted pairs

*Consult us for length > 100m

SSI CONNECTION

Type	Vcc	Gnd	Clk+	Data+	RAZ	Data-	Clk-	DIRECTION
S5	BN/GN Brown/Green	WH/GN White/Green	GN Green	GY Grey	BU Blue	PK Pink	BN Brown	WH White

Note : Do not connect other pinouts, connect DIRECTION and RAZ to a potential (RAZ at 0V if not used)

Data output RS422

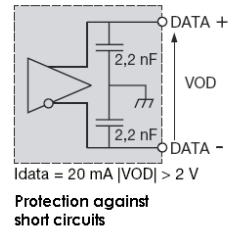

Isolated Clk input

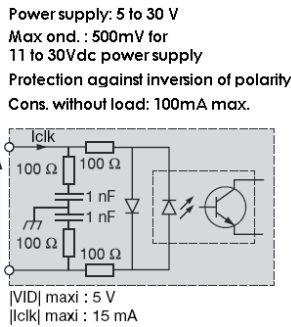

DIRECTION input

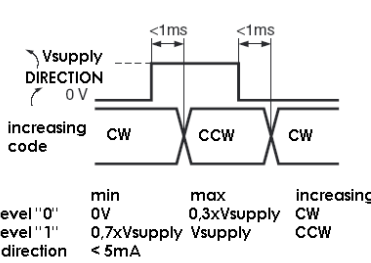

RAZ / RAX input

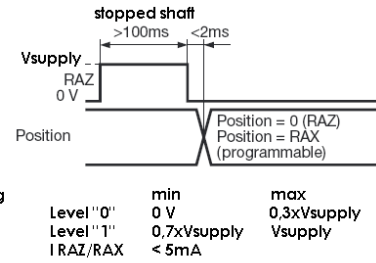

ORDERING CODE

	Shaft Ø	Supply	Output stage	Code	Resolution Number of turns	Connection	Connection Orientation
PEUX (stainless steel)	30:30 mm	P: 5-30Vdc	SS: SSI without parity SP: SSI with even parity SI: SSI with odd parity	B Binary G : Gray	13B12D5 : Resolution : 13 bits Number of turns : 12 bits D5: 25bits frame	S5: cable gland + cable	Example : R030 : radial cable 3m
PAUX (aluminium)							
PEUX	- 30 //	P	SS	G //	13 B12 D5 //	S5	R030

ASSEMBLY CAUTION

NEVER OPEN THE ENCODER

NEVER CONNECT/DISCONNECT UNDER POWER SUPPLY/ IN PRESENCE OF DUSTS ATMOSPHERE

The customer obliges to take up and to use our products, according to our specifications and to the manners of the profession. Our company would not be responsible for any defect resulting from a defective or erroneous assembly. From a use superior to the standard, or in abnormal conditions. The breakdowns resultant of shocks, bad electric supply, put in low capacity or overcapacity of the product, the environment of bad conditions (humidity, projection, dust, etc) cannot be imputed to us. The converter doesn't require any maintenance. Any encoder presenting a dysfunction will have to be the object of immediate return for control in our facilities. The encoder mustn't be open in any case (cable gland and/or cover). An earth situated on the cover must be linked with the ground of the installation.

Made in FRANCE

ATEX ABSOLUTE SSI MULTI TURN ENCODER, PAUX RANGE

1) Déclaration de conformité CE

2) Nous, société BEI Sensors, certifions que ce matériel : capteurs antidéflagrants, type

GAUX, CAUX, PAUX, GELX, CEUX, PEUX

3) Avec les inscriptions suivantes :

CE0081  **II 2 G/D, Ex d IIC T_B, T_B ou T_A
Ex tD A21 IP6X T₈₀°C T₈₅°C T₁₀₀°C**

A été conçu et fabriqué conformément à la directive applicable suivante :

ATEX directive 94/9/CE

Directive CEM 89/336/CEE

4) La certification a été obtenu grâce à l'application des normes suivantes :

EN 60079-0 (2006), EN 60079-1 (2004), EN 61241-0 (2004) et EN 61241-1 (2004)

5) Une attestation d'examen CE de type a été obtenu :

ICIE03 ATEX 6407

et une notification :

ICIE03 ATEX Q8060

6) L'application des normes suivantes a participé à l'obtention de la certification :

EN 60-529, NFC 23-520, NFC 23-539, EN 50081-1, EN 55022 classe B, EN 55014, EN 61000-6-2, CEI 61000-4-2, CEI 61000-4-3, CEI 61000-4-4, CEI 61000-4-5, CEI 61000-4-6, CEI 61000-4-8, CEI 61000-4-11

7) L'organisme notifié responsable du suivi de la directive **ATEX** est le

LCIE, B.P. 8, F92260 Fontenay-aux-Roses

Numéro d'identification : 0081

8) La société chargée de la certification **CEM** est nommée ci-après :

GRME, Cellule CEM, B.P. 8, 68840 Pulversheim

9) Nous certifions que nos produits désignés ci-dessus sont conformes à la directive et aux normes spécifiées

Date :

ATEX Certified Product Approved Person

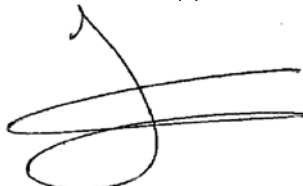

1) Declaration of conformity EC

2) We, BEI Sensors, certify that this material : sensor explosion-proof standard

GAUX, CAUX, PAUX, GELX, CEUX, PEUX

3) With the following inscriptions :

CE0081  **II 2 G/D, Ex d IIC T_B, T_B or T_A
Ex tD A21 IP6X T₈₀°C T₈₅°C T₁₀₀°C**

Conceived and manufactured has the directive applicable following :

ATEX directive 94/9/CE

Directive CEM 89/336/CEE

4) Certification to summer obtained thanks to the application of the standards :

EN 60079-0 (2006), EN 60079-1 (2004), EN 61241-0 (2004) and EN 61241-1 (2004)

5) EC type examination certificate was obtained :

ICIE03 ATEX 6407

and a notification :

ICIE03 ATEX Q8060

6) The application of the following standards took part in obtaining certification :

EN 60-529, NFC 23-520, NFC 23-539, EN 50081-1, EN 55022 classe B, EN 55014, EN 61000-6-2, CEI 61000-4-2, CEI 61000-4-3, CEI 61000-4-4, CEI 61000-4-5, CEI 61000-4-6, CEI 61000-4-8, CEI 61000-4-11

7) The notified organization responsible for the follow-up of the directive **ATEX** is the

LCIE, B.P. 8, F92260 Fontenay-aux-Roses

Identification number : 0081

8) The company in charge of certification **CEM** is named :

GRME, Cellule CEM, B.P. 8, 68840 Pulversheim

9) We certify that our indicated products so above are in conformity with the directive and the specified standards