

Sec: A - A

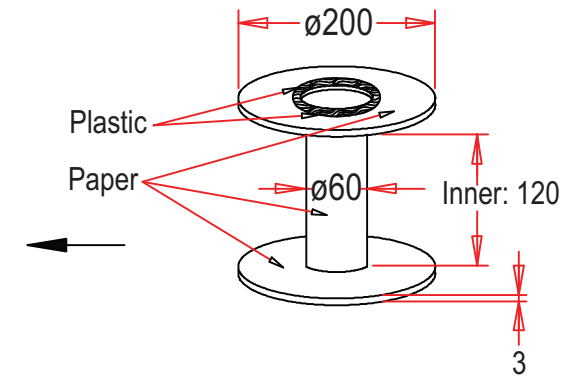

500Ft/R. "PE" Foam Wrapped

Unit: MM

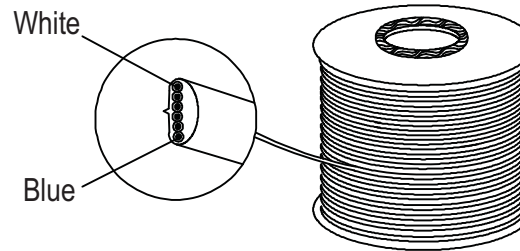

ITEM NO.
AT-K-26-6-B/500-R

TITLE
 Modular Straight cable - Raw, 6 Contact, 26AWG,
 Black, 500Ft

ASSMANN
 Electronics, Inc.

1840 W. Drake Drive, Suite 101 • Tempe, AZ 85283
 Toll Free: 1-877-277-6266 • Email: info@usa-assmann.com

THIS DRAWING IS UNPUBLISHED
 ©Copyright 2011 by Assmann Electronic Components
 All International Rights Reserved