



RIoTboard

Revolutionizing the **Internet of Things**

Table of Contents

1	BOARD OVERVIEW.....	7
1.1	PRODUCT INTRODUCTION.....	7
1.2	FEATURES.....	8
2	HARDWARE DESCRIPTION.....	11
2.1	PROCESSOR.....	11
2.1.1	<i>Core Features.....</i>	<i>11</i>
2.1.2	<i>External memory interfaces:.....</i>	<i>12</i>
2.1.3	<i>Interface to external devices.....</i>	<i>13</i>
2.1.4	<i>Advanced Power Management unit.....</i>	<i>14</i>
2.1.5	<i>Hardware Accelerators.....</i>	<i>14</i>
2.2	EXPANDED CHIP INTRODUCTION.....	15
2.2.1	<i>MT41K256M16HA-125:E.....</i>	<i>15</i>
2.2.2	<i>MMPF0100NPAEP.....</i>	<i>15</i>
2.2.3	<i>AR8035.....</i>	<i>15</i>
2.2.4	<i>FE1.1.....</i>	<i>16</i>
2.2.5	<i>SGTL5000.....</i>	<i>16</i>
2.3	EXPANDED CHIP INTRODUCTION.....	17
2.3.1	<i>Power Input Jack.....</i>	<i>17</i>
2.3.2	<i>LVDS Interface.....</i>	<i>18</i>
2.3.3	<i>HDMI Interface.....</i>	<i>19</i>
2.3.4	<i>Microphone Input Jack.....</i>	<i>21</i>
2.3.5	<i>Audio Output Jack.....</i>	<i>22</i>
2.3.6	<i>SD Card Interface.....</i>	<i>23</i>
2.3.7	<i>uSD/MMC Card Interface.....</i>	<i>24</i>
2.3.8	<i>CSI Interface.....</i>	<i>25</i>
2.3.9	<i>Camera Interface.....</i>	<i>26</i>



2.3.10	JTAG Interface	28
2.3.11	Mini USB Interface	29
2.3.12	Serial Port	30
2.3.13	Expansion Port Interface	31
2.3.14	Mini USB Interface (OpenSDA)	33
2.3.15	RGMII LAN Interface	34
2.3.16	USB HUB Interface	35
2.3.17	Boot Configuration Select	36
2.3.18	Reset Switch	38
2.3.19	LEDs	39
3	GETTING STARTED	40
3.1	SOFTWARE FEATURES	40
3.2	LINUX SYSTEM	40
3.3	ANDROID SYSTEM	41
3.4	SETTING UP TERMINAL EMULATION	42
4	DOWNLOADING AND RUNNING THE SYSTEM	43
4.1	DOWNLOAD AND RUN LINUX OR ANDROID SYSTEM	43
4.2	DISPLAY MODE CONFIGURATIONS FOR LINUX & ANDROID SYSTEMS	46
5	MAKING IMAGES	48
5.1	MAKING IMAGES FOR LINUX	48
5.1.1	Getting Tools and Source Code	48
5.1.2	Compiling System Images	48
5.2	MAKING IMAGES FOR AN ANDROID SYSTEM	49
5.2.1	Getting Repo Source Code	49
5.2.2	Compiling System Images	50
6	ESD PRECAUTIONS AND PROPER HANDLING PROCEDURES	52

LIST OF FIGURES

<i>Figure 1-1 Functional Block Diagram</i>	7
<i>Figure 1-2 RIoTboard top view</i>	8
<i>Figure 1-3 RIoTboard bottom view</i>	9
<i>Figure 2-1 Block Diagram of i.MX 6Solo</i>	12
<i>Figure 2-2 Power Interface</i>	17
<i>Figure 2-3 LVDS Interface</i>	18
<i>Figure 2-4 HDMI Interface</i>	19
<i>Figure 2-5 MIC Input</i>	21
<i>Figure 2-6 Audio Output Jack</i>	22
<i>Figure 2-7 SD Card Interface</i>	23
<i>Figure 2-8 uSD/MMC Card Interface</i>	24
<i>Figure 2-9 CSI Interface</i>	25
<i>Figure 2-10 Camera Interface</i>	26
<i>Figure 2-11 JTAG Interface</i>	28
<i>Figure 2-12 Mini USB Interface</i>	29
<i>Figure 2-13 Serial Port</i>	30
<i>Figure 2-14 Expansion Port</i>	31
<i>Figure 2-15 Mini USB (OpenSDA)Interface</i>	33
<i>Figure 2-16 RGMII LAN Interface</i>	34
<i>Figure 2-17 USB Host Interface</i>	35
<i>Figure 2-18 Boot Configuration Select</i>	36
<i>Figure 2-19 Reset Switch</i>	38
<i>Figure 2-20 LEDs</i>	39



Figure 3-1 COM Properties..... 42

Figure 4-1 Boot Configuration Switch 43

LIST OF TABLES

Table 2-1 Power Interface..... 17

Table 2-2 LVDS Interface..... 18

Table 2-3 HDMI Interface..... 19

Table 2-4 MIC Input Jack..... 21

Table 2-5 Audio Output Jack..... 22

Table 2-6 SD Card Interface 23

Table 2-7 uSD/MMC Card Interface..... 24

Table 2-8 CSI Interface 25

Table 2-9 Camera Interface 27

Table 2-10 JTAG Interface..... 28

Table 2-11 Mini USB Interface 29

Table 2-12 Serial Port..... 30

Table 2-13 Expansion Port Interface 31

Table 2-14 Mini USB (OpenSDA) Interface..... 33

Table 2-15 RGMII LAN interface..... 34

Table 2-16 USB Host Interface 35

Table 2-17 Boot Configuration Select 37

Table 2-18 Reset Switch..... 38

Table 2-19 LEDs..... 39

Table 3-1 OS and Drivers..... 40

Table 3-2 Images Required by Linux..... 40



<i>Table 3-3 Storage Partitions for Linux.....</i>	<i>41</i>
<i>Table 3-4 Images Required by Android</i>	<i>41</i>
<i>Table 3-5 Storage Partitions for Android.....</i>	<i>41</i>
<i>Table 4-1 Boot Switch Configuration – Serial Download.....</i>	<i>43</i>
<i>Table 4-2 Boot Switch Configuration - eMMC.....</i>	<i>46</i>
<i>Table 4-3 Boot Switch Configuration – SD</i>	<i>46</i>
<i>Table 5-1 Images and Directories</i>	<i>51</i>

1 Board Overview

1.1 Product Introduction

The RIoTboard is an evaluation platform featuring the powerful i.MX 6Solo, a multimedia application processor with ARM Cortex-A9 core at 1 GHz from Freescale Semiconductor. The platform helps evaluate the rich set of peripherals and includes a 10/100/Gb Ethernet port, HDMI v1.4, LVDS, analog headphone/microphone, uSD and SD card interface, USB, serial port, JTAG, 2 camera interfaces, GPIO boot configuration interface, and expansion port, as shown in Figure 1-1.

The RIoTboard can be used in the following applications:

- Netbooks (web tablets)
- Nettops (Internet desktop devices)
- High-end mobile Internet devices (MID)
- High-end PDAs
- High-end portable media players (PMP) with HD video capability
- Portable navigation devices (PNDs)
- Industrial control and Test and measurement (T&M)
- Single board computers (SBCs)

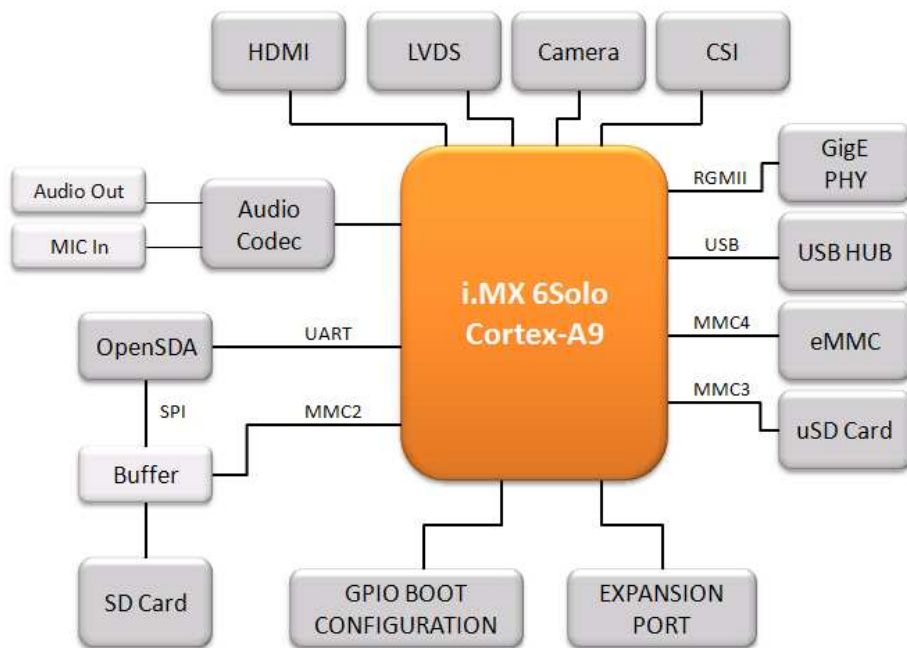

Figure 1-1 Functional Block Diagram

1.2 Features

The RIoTboard is based on the i.MX 6Solo processor from Freescale Semiconductor integrating all the functionalities of this multimedia application processor with the following features:

- Mechanical Parameters
 - Working Temperature: 0°C - 50°C
 - Humidity Range: 20% - 90%
 - Dimensions: 120mm x 75mm
 - Input Voltage: +5V
- Processor
 - ARM Cortex A9 MPCore™ Processor at 1 GHz
 - High-performing video processing unit which covers SD-level and HD-level video decoders and SD-level encoders as a multi-standard video codec engine
 - An OpenGL® ES 2.0 3D graphics accelerator with a shader and a 2D graphics accelerator for superior 3D, 2D, and user interface acceleration
- Memories
 - 1GByte of 16-bit wide DDR3 @ 800MHz
 - 4GB eMMC

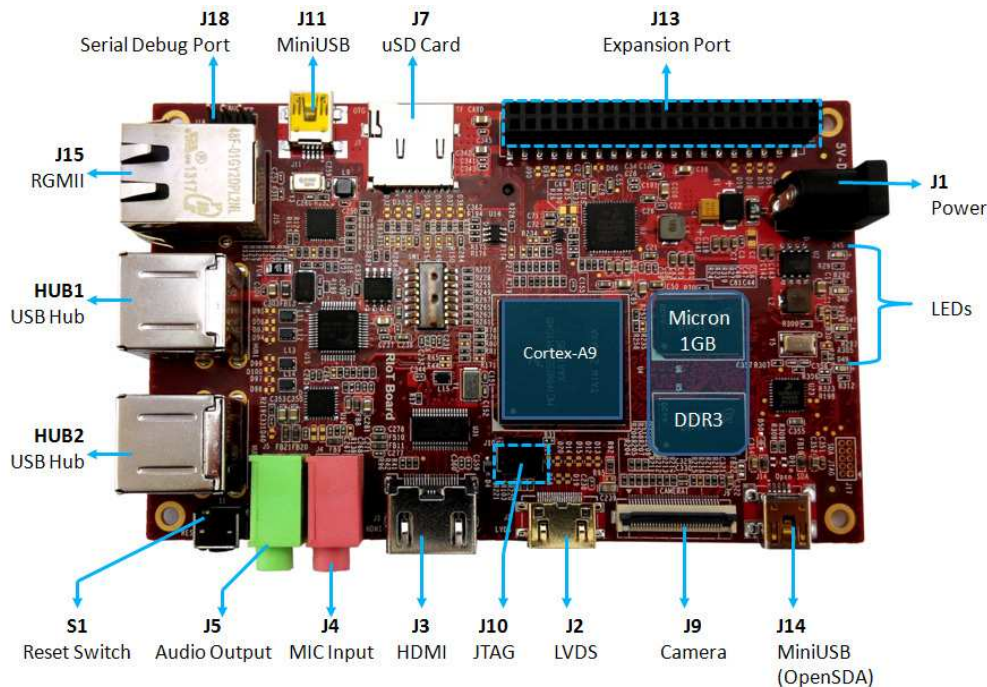

Figure 1-2 RIoTboard top view

- Media Interfaces
 - Analog headphone/microphone, 3.5mm audio jack
 - LVDS interface
 - HDMI interface
 - Parallel RGB interface(Expansion port)
 - Camera interface (Support CCD or CMOS camera)
 - MIPI lanes at 1 Gbps

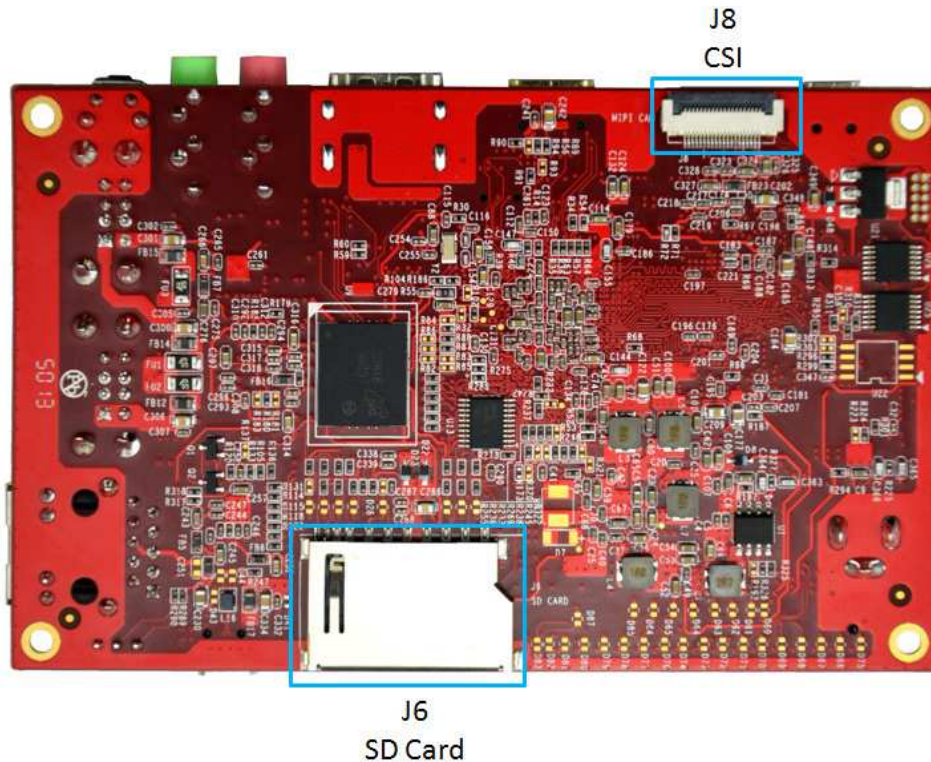

Figure 1-3 RIoTboard bottom view

- Data Transfer Interfaces
 - Debug Ports:
 - 3 pin TTL level
 - Serial Ports:
 - UART3,4,5, 3 line serial port, TTL Logic (Expansion port)
 - USB Ports:
 - 1 x USB2.0 OTG, mini USB, high-speed, 480Mbps
 - 4 x USB2.0 HOST, Type A, high-speed, 480Mbps
 - uSD card interface
 - SD card interface
 - 10M/100M/Gb Ethernet Interface (RJ45 jack)

-
- 2 channel I2C interface (Expansion port)
 - 2 channel SPI interface (Expansion port)
 - 3 channel PWM interface (Expansion port)
 - GPIO (Expansion port)
 - 10-pin JTAG interface
 - Open SDA

 - Others
 - 1 Power LED
 - 1 Open SDA LED
 - 2 User-defined LEDs
 - 1 DC Jack
 - 1 Reset button
 - Boot configuration interface

2 Hardware Description

2.1 Processor

The i.MX 6Solo processor represents Freescale Semiconductor's latest achievement in integrated multimedia applications processors, which are part of a growing family of multimedia-focused products that offer high performance processing and are optimized for lowest power consumption.

The processor features Freescale's advanced implementation of the single ARM™ Cortex-A9 core, which operates at speeds up to 1 GHz. It includes 2D and 3D graphics processors, 3D 1080p video processing, and integrated power management. The processor provides a 16/32-bit DDR3/LVDDR3-800 memory interface and a number of other interfaces for connecting peripherals, such as WLAN, Bluetooth™, GPS, hard drive, displays, and camera sensors.

2.1.1 Core Features

The i.MX 6Solo processor is based on the ARM Cortex A9 MPCore™ platform with the following features:

- ARM Cortex A9 MPCore™ CPU Processor (with TrustZone)
- The core configuration is symmetric, where the core includes:
 - 32 KByte L1 Instruction Cache
 - 32 KByte L1 Data Cache
 - Private Timer and Watchdog
 - Cortex-A9 NEON MPE (Media Processing Engine) Co-processor
- The ARM Cortex A9 MPCore™ complex includes:
 - General Interrupt Controller (GIC) with 128 interrupt support
 - Global Timer
 - Snoop Control Unit (SCU)
 - 512 KB unified I/D L2 cache
 - Two Master AXI (64-bit) bus interfaces output of L2 cache
 - NEON MPE coprocessor
 - SIMD Media Processing Architecture
 - NEON register file with 32x64-bit general-purpose registers
 - NEON Integer execute pipeline (ALU, Shift, MAC)
 - NEON dual, single-precision floating point execute pipeline (FADD, FMUL)
 - NEON load/store and permute pipeline
- The memory system consists of the following components:
 - Level 1 Cache--32 KB Instruction, 32 KB Data cache per core

- Level 2 Cache--Unified instruction and data (512 KByte)
- On-Chip Memory:
 - Boot ROM, including HAB (96 KB)
 - Internal multimedia / shared, fast access RAM (OCRAM, 128 KB)
 - Secure/non-secure RAM (16 KB)

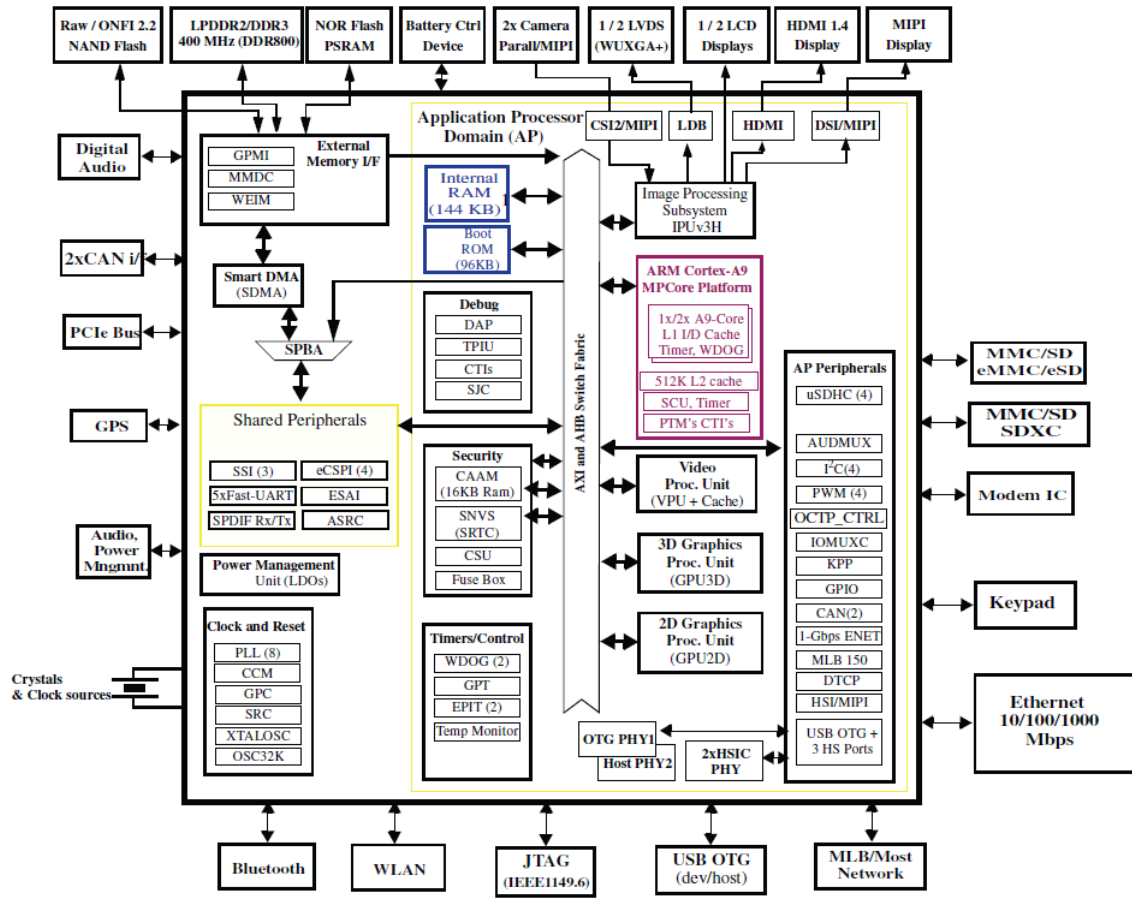

Figure 2-1 Block Diagram of i.MX 6Solo

2.1.2 External memory interfaces:

- 16/32-bit LP-DDR2-800, 16/32-bit DDR3-800 and LV-DDR3-800.
- 8-bit NAND-Flash, including support for Raw MLC/SLC, 2 KB, 4 KB, and 8 KB page size, BA-NAND, PBA-NAND, LBA-NAND, OneNAND™ and others. BCH ECC up to 40 bit.
- 16/32-bit NOR Flash. All WEIMv2 pin are muxed on other interfaces.
- 16/32-bit PSRAM, Cellular RAM

2.1.3 Interface to external devices

Each i.MX 6Solo processor enables the following interfaces to external devices (some of them are muxed and not available simultaneously):

- Displays--Total five interfaces available. Total raw pixel rate of all interfaces is up to 450 Mpixels/sec, 24 bpp. Up to two interfaces may be active in parallel.
 - One Parallel 24-bit display port, up to 225 Mpixels/sec (for example, WUXGA at 60 Hz or dual HD1080 and WXGA at 60 Hz)
 - LVDS serial ports : One port up to 165 Mpixels/sec or two ports up to 85 MP/sec (for example, WUXGA at 60 Hz) each
 - HDMI 1.4 port
 - MIPI/DSI, two lanes at 1 Gbps
 - EPDC, Color, and monochrome E-INK, up to 1650x2332 resolution and 5-bit grayscale
- Camera sensors:
 - Two parallel Camera ports (up to 20 bit and up to 240 MHz peak)
 - MIPI CSI-2 serial camera port, supporting from 80 Mbps to 1 Gbps speed per data lane. The CSI-2 Receiver core can manage one clock lane and up to two data lanes. Each i.MX 6Solo processor has two lanes.
- Expansion cards:
 - Four MMC/SD/SDIO card ports all supporting:
 - 1-bit or 4-bit transfer mode specifications for SD and SDIO cards up to UHS-I SDR-104 mode (104 MB/s max)
 - 1-bit, 4-bit, or 8-bit transfer mode specifications for MMC cards up to 52 MHz in both SDR and DDR modes (104 MB/s max)
- USB
 - One high speed (HS) USB 2.0 OTG (Up to 480 Mbps), with integrated HS USB PHY
 - Three USB 2.0 (480 Mbps) hosts
 - One HS host with integrated High Speed PHY
 - Two HS hosts with integrated HS-IC USB (High Speed Inter-Chip USB) PHY
- Expansion PCI Express port (PCIe) v2.0 one lane
 - PCI Express (Gen 2.0) dual mode complex, supporting Root complex operations and Endpoint operations. Uses x1 PHY configuration.
- Miscellaneous IPs and interfaces:
 - Three I2S/SSI/AC97, up to 1.4 Mbps each
 - Enhanced Serial Audio Interface (ESAI), up to 1.4 Mbps per channel
 - Five UARTs, up to 4.0 Mbps each
 - Providing RS232 interface
 - Supporting 9-bit RS485 multidrop mode

-
- One of the five UARTs (UART1) supports 8-wire while the other four support 4-wire. This is due to the SoC IOMUX limitation, since all UART IPs are identical
 - Four eCSPI (Enhanced CSI)
 - Four I2C, supporting 400 kbps
 - Gigabit Ethernet Controller(IEEE1588 compliant), 10/100/1000 Mbps
 - Four Pulse Width Modulators (PWM)
 - System JTAG Controller (SJC)
 - GPIO with interrupt capabilities
 - 8x8 Key Pad Port (KPP)
 - Sony Philips Digital Interface (SPDIF), Rx and Tx
 - Two Controller Area Network (FlexCAN), 1 Mbps each
 - Two Watchdog timers (WDOG)
 - Audio MUX (AUDMUX)
 - MLB (MediaLB) provides interface to MOST Networks (MOST25, MOST50, MOST150) with the option of DTCP cipher accelerator

2.1.4 Advanced Power Management unit

The i.MX 6Solo processors integrate advanced power management unit and controllers:

- Provide PMU, including LDO supplies, for on-chip resources
- Use Temperature Sensor for monitoring the die temperature
- Support DVFS techniques for low power modes
- Use SW State Retention and Power Gating for ARM and MPE
- Support various levels of system power modes
- Use flexible clock gating control scheme

2.1.5 Hardware Accelerators

The i.MX 6Solo processor uses dedicated hardware accelerators to meet the targeted multimedia performance. The use of hardware accelerators is a key factor in obtaining high performance at low power consumption numbers, while having the CPU core relatively free for performing other tasks.

The i.MX 6Solo processor incorporates the following hardware accelerators:

- VPU--Video Processing Unit
- IPUv3H--Image Processing Unit version 3H
- GPU3Dv5--3D Graphics Processing Unit (OpenGL ES 2.0) version 5
- GPU2Dv2--2D Graphics Processing Unit (BitBlit)
- ASRC--Asynchronous Sample Rate Converter

Security functions are enabled and accelerated by the following hardware:

- ARM TrustZone including the TZ architecture (separation of interrupts, memory mapping, etc.)
- SJC--System JTAG Controller. Protecting JTAG from debug port attacks by regulating or blocking the access to the system debug features.
- CAAM--Cryptographic Acceleration and Assurance Module, containing cryptographic and hash engines, 16 KB secure RAM and True and Pseudo Random Number Generator (NIST certified)
- SNVS--Secure Non-Volatile Storage, including Secure Real Time Clock
- CSU--Central Security Unit. Enhancement for the IC Identification Module (IIM). Will be configured during boot and by eFUSES and will determine the security level operation mode as well as the TZ policy.
- A-HAB Advanced High Assurance Boot--Hv4 with the new embedded enhancements:SHA-256, 2048-bit RSA key, version control mechanism, warm boot, CSU, and TZ initialization.

2.2 Expanded Chip Introduction

2.2.1 MT41K256M16HA-125:E

The board has 1GB of SDRAM (2x512MB). Micron's MT41K256M16 is a 512MB DDR3 Synchronous DRAM, ideally suited for the main memory applications which require large memory density and high bandwidth.

2.2.2 MMPF0100NPAEP

The PF0100 Power Management Integrated Circuit (PMIC) provides a highly programmable/ configurable architecture, with fully integrated power devices and minimal external components. With up to six buck converters, six linear regulators, RTC supply, and coin-cell charger, the PF0100 can provide power for a complete system, including applications processors, memory, and system peripherals, in a wide range of applications. With on-chip One Time Programmable (OTP) memory, the PF0100 is available in pre-programmed standard versions, or non-programmed to support custom programming. The PF0100 is defined to power the entire embedded MCU platform solution similar to i.MX6 based eReader, IPTV, medical monitoring and home/factory automation.

2.2.3 AR8035

AR8035 is a single port 10/100/1000 Mbps tri-speed Ethernet PHY featured with low power and low cost. AR8035 supports MAC.TM RGMII interface and IEEE 802.3az-2010, Energy Efficient Ethernet (EEE) standard through proprietary SmartEEE technology, improving energy efficiency in systems using legacy MAC devices without 802.3az

support. The RIOT Board can be connected to a network hub directly through a cable. It also can be directly connected with a computer through a crossover cable which is provided with the kit.

2.2.4 FE1.1

FE1.1 is a USB 2.0 high-speed 4-port hub solution. It uses USB3320 to provide 4 extended USB interface with support for high-speed (480MHz), full-speed (2MHz) and low-speed (1.5MHz) mode.

2.2.5 SGTL5000

The SGTL5000 is a low power stereo Codec with Headphone Amp from Freescale, and is designed to provide a complete audio solution for portable products needing line-in, mic-in, line-out, headphone-out, and digital I/O. Deriving its architecture from best-in-class Freescale-integrated products currently on the market, the SGTL5000 is able to achieve ultra low-power with very high performance and functionality, all in one of the smallest footprints available.

Designed with features such as capless headphone and an integrated PLL to allow clock reuse within the system, it helps customers achieve a lower overall system cost.

2.3 Expanded Chip Introduction

2.3.1 Power Input Jack

A 5V/1A AC-to-DC power supply needs to be plugged into the Power Jack (J1) on the board. *It is not recommended to use a higher voltage since possible damage to the board may result due to failure of the protection circuitry.*

Figure 2-2 Power Interface

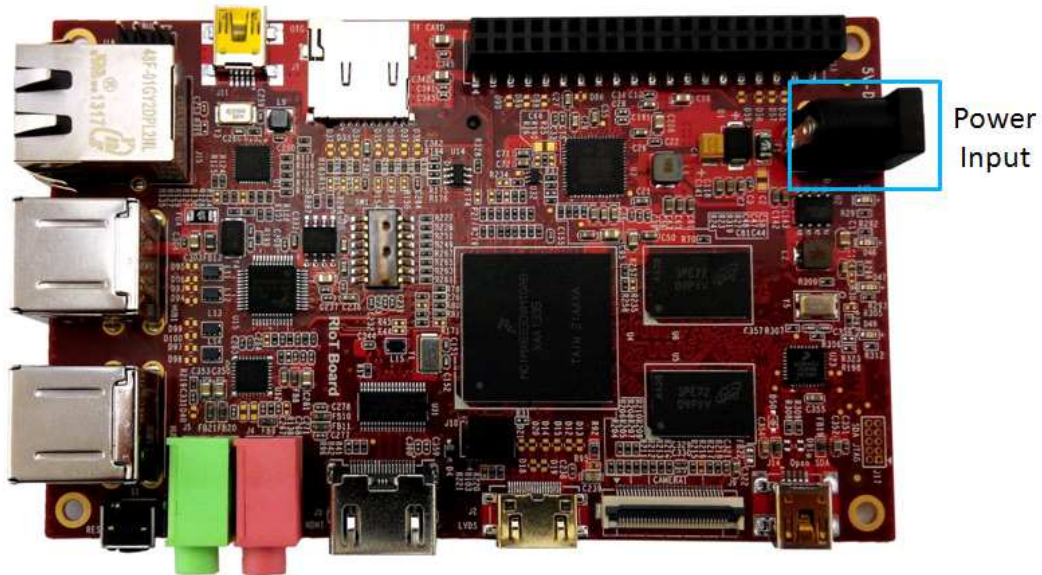
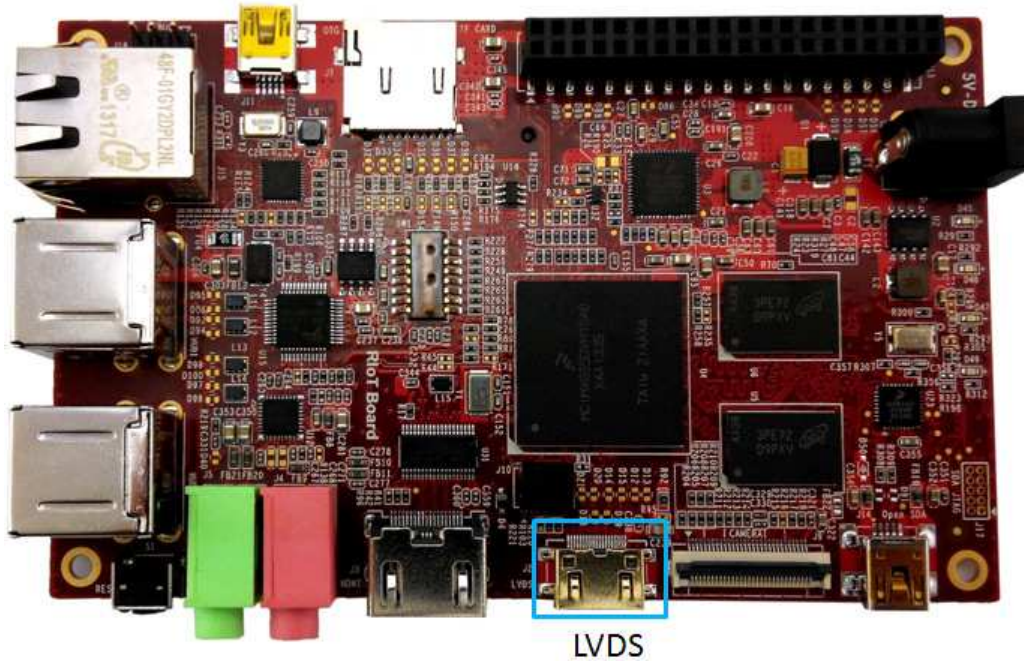

Table 2-1 Power Interface

J1		
Pin	Signal	Function
1	GND	GND
2	NC	NC
3	+5V	Power supply (+5V) 1A (Type)

2.3.2 LVDS Interface

Figure 2-3 LVDS Interface



The LVDS Interface supports LVDS8000-97C designed by Embest.

Table 2-2 LVDS Interface

J2		
Pin	Signal	Function
1	3V3	+3.3V
2	LVDS_TX2_P	LVDS data2+
3	LVDS_TX2_N	LVDS data2-
4	GND	GND
5	LVDS_TX1_P	LVDS data1+
6	LVDS_TX1_N	LVDS data1-
7	GND	GND
8	LVDS_TX0_P	LVDS data0+
9	LVDS_TX0_N	LVDS data-
10	GND	GND
11	LVDS_CLK_P	LVDS CLK+
12	LVDS_CLK_N	LVDS CLK-

13	LCD_PWR_EN	Touch reset signal
14	Touch_Int	Touch interrupt signal
15	I2C_SCL	IIC master serial clock
16	I2C_SDA	IIC master serial data
17	LED_PWR_EN	Backlight enable
18	5V	+5V
19	PWM	Pulse Width Modulation

2.3.3 HDMI Interface

Figure 2-4 HDMI Interface

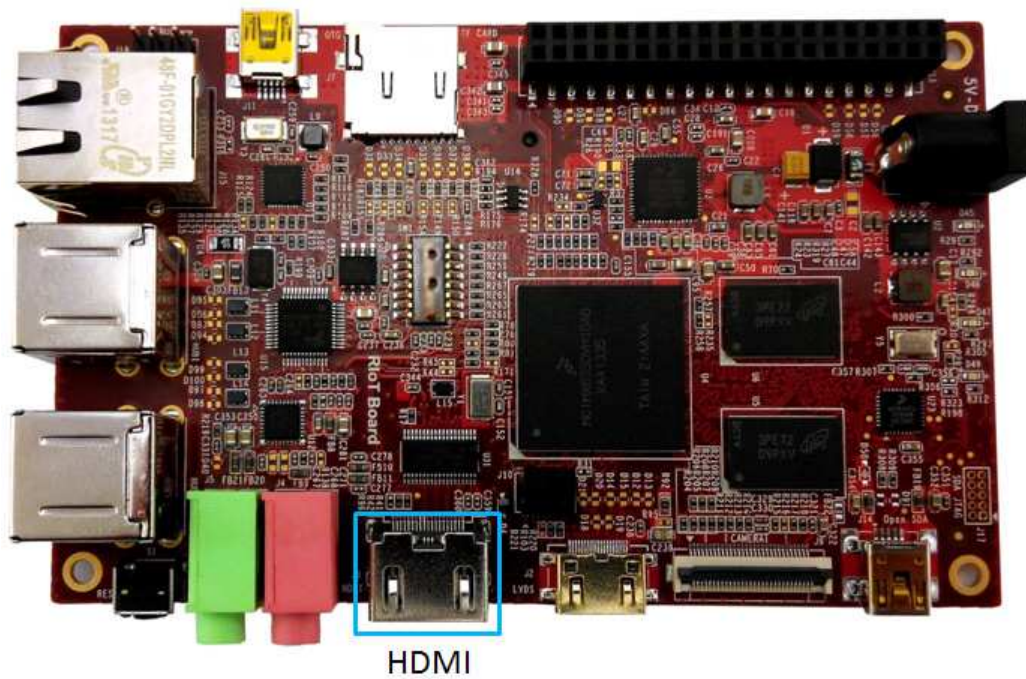

Table 2-3 HDMI Interface

J3		
Pin	Signal	Function
1	HDMI_D2P	HDMI differential pairs data2+
2	GND	GND
3	HDMI_D2M	HDMI differential pairs data2-
4	HDMI_D1P	HDMI differential pairs data1+
5	GND	GND

6	HDMI_D1M	HDMI differential pairs data1-
7	HDMI_D0P	HDMI differential pairs data0+
8	GND	GND
9	HDMI_D0M	HDMI differential pairs data0-
10	HDMI_CLKP	HDMI differential pairs clock+
11	GND	GND
12	HDMI_CLKM	HDMI differential pairs clock-
13	NC	NC
14	NC	NC
15	I2C2_SCL	IIC2 serial clock
16	I2C2_SDA	IIC2 serial data
17	GND	GND
18	5Vin	5V
19	HDMI_HPD	HDMI detect
20	GNF_DVI	GND

2.3.4 Microphone Input Jack

The RIoTboard provides a 3.5mm stereo connector for a microphone input, as shown in Figure 2-5. A mono microphone will input its signal through the tip of the 3.5mm plug.

Figure 2-5 MIC Input

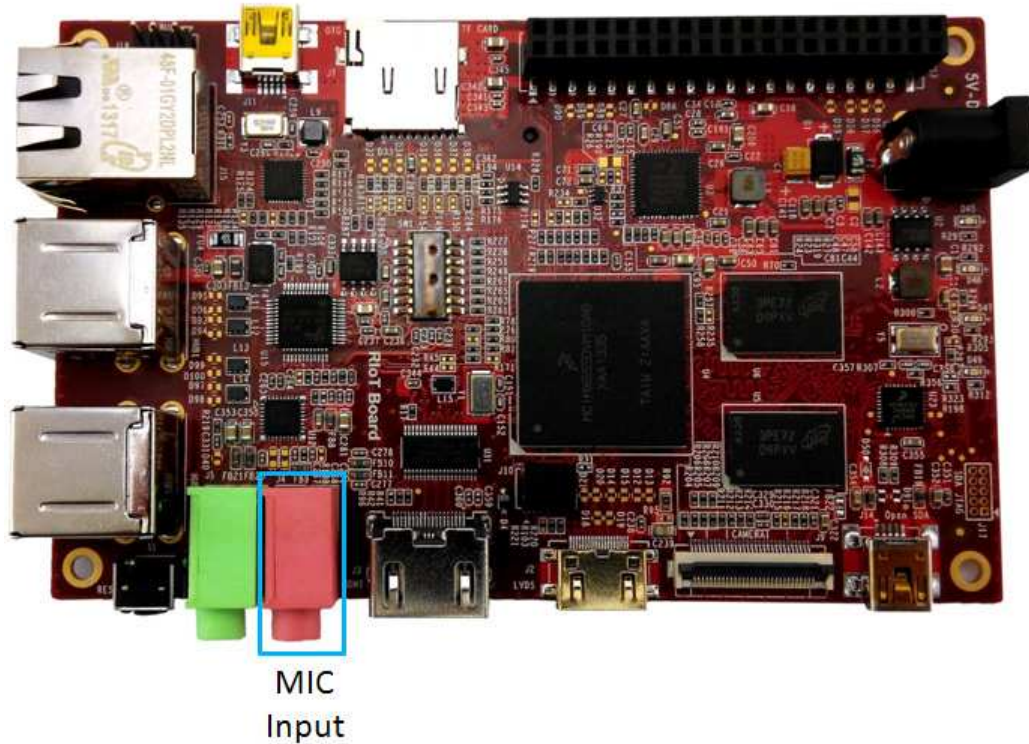

Table 2-4 MIC Input Jack

J4		
Pin	Signal	Function
1	GND_ANALOG	Analog GND
2	MIC_IN_P	MIC input analog GND
3	GND_ANALOG	Analog GND
4	GND_ANALOG	Analog GND
5	MIC_IN_P	MIC input analog GND

2.3.5 Audio Output Jack

A headphone with a standard 3.5mm stereo jack can be connected to the Audio Output jack at the point shown in Figure 2-6.

Figure 2-6 Audio Output Jack

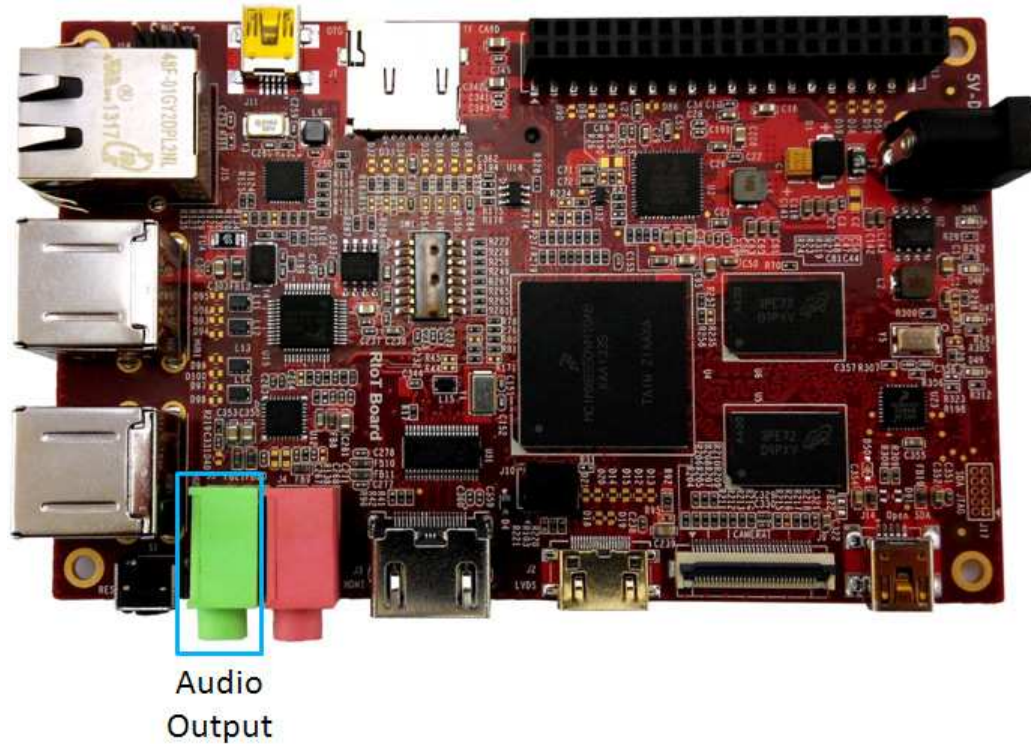

Table 2-5 Audio Output Jack

J5		
Pin	Signal	Function
1	GND_ANALOG	Analog GND
2	LINEOUT_L	Left output
3	LINEOUT_R	Right output
4	LINEOUT_R	Right output
5	LINEOUT_L	Left output

2.3.6 SD Card Interface

Figure 2-7 SD Card Interface

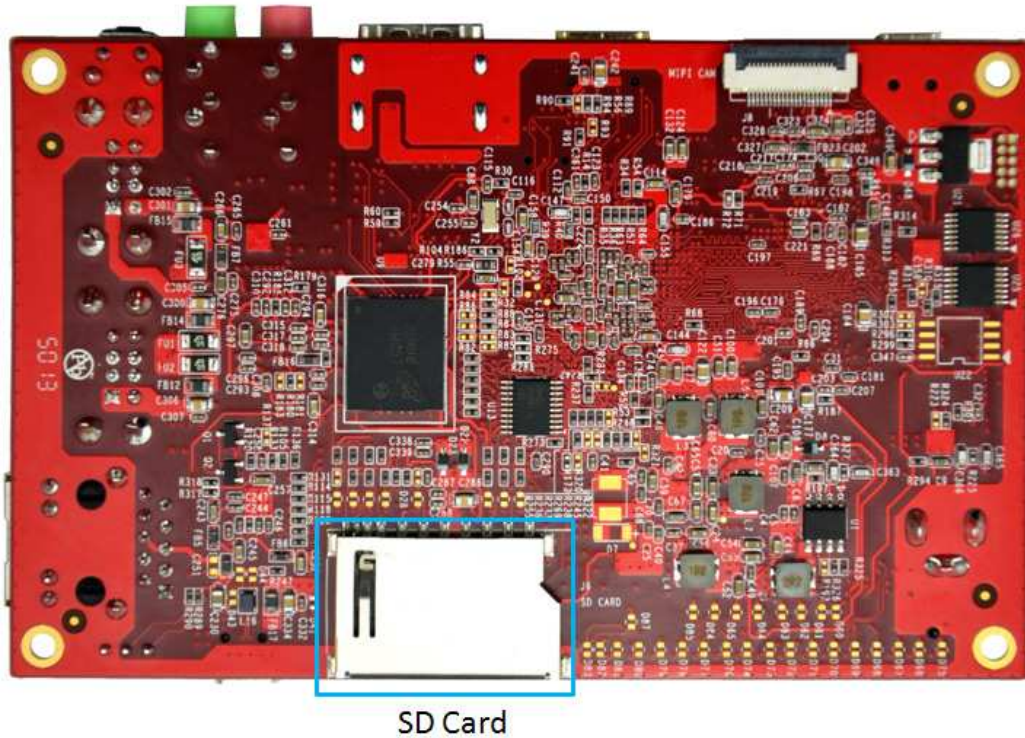

Table 2-6 SD Card Interface

J6		
Pin	Signal	Function
1	SD2_DAT3	Card data 3
2	SD2_CMD	Command signal
3	GND	GND
4	3P3V	3.3V
5	SD2_CLK	Clock
6	VSS	GND
7	SD2_DAT0	Card data 0
8	SD2_DAT1	Card data 1
9	SD2_DAT2	Card data 2

10	SD2_CD	Card detect
11	SD2_WP	Card write protected
12	GND	GND
13	GND	GND
14	GND	GND
15	GND	GND

2.3.7 uSD/MMC Card Interface

The micro SD Card Connector (J7) connects a 4-bit parallel data bus to the SD3 port of the i.MX 6 processor. The micro SD Card is inserted facing up at the location shown in Figure 2-8.

Figure 2-8 uSD/MMC Card Interface

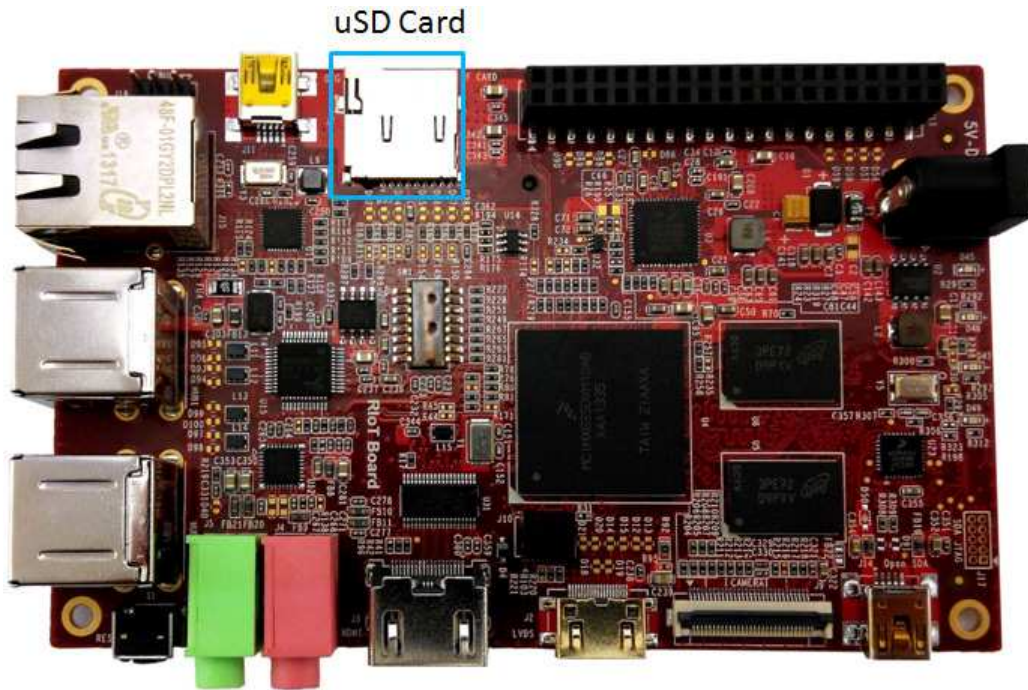

Table 2-7 uSD/MMC Card Interface

J7		
Pin	Signal	Function
1	SD3_DAT2	Card data 2
2	SD3_DAT3	Card data 3
3	CMD	Card command signal

4	3P3V	3P3V
5	SD3_CLK	Card clock
6	VSS	GND
7	SD3_DAT0	Card data 0
8	SD3_DAT1	Card data 1
9	SD3_CD	Card detect
10	PGND	GND

2.3.8 CSI Interface

Figure 2-9 CSI Interface

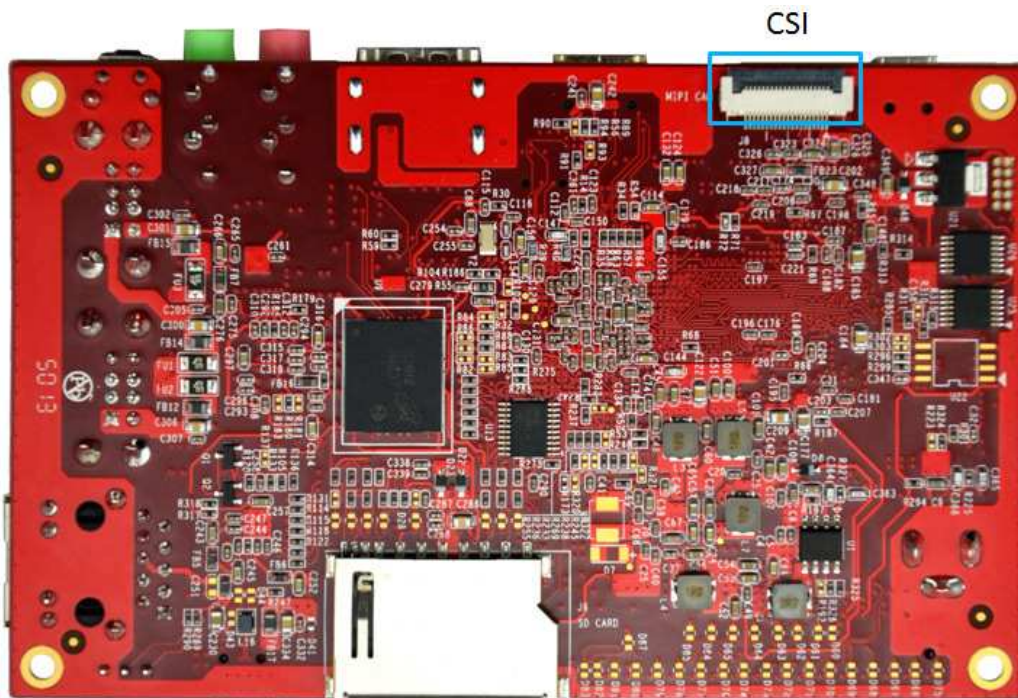

Table 2-8 CSI Interface

J8		
Pin	Signal	Function
1	5VIN	5V
2	5VIN	5V
3	GND	GND
4	GND	GND

5	P2V8_VGEN6	2.8V
6	CSI_MCLK	CSI clock
7	GND	GND
8	CSI_RST	CSI reset
9	CSI_EN	CSI data enable
10	I2C4_SCL	IIC2 serial clock
11	I2C4_SDA	IIC2 serial data
12	GND	GND
13	CSI_CLK0M	CSI differential pairs clock0-
14	CSI_CLK0P	CSI differential pairs clock0+
15	GND	GND
16	CSI_D0M	CSI differential pairs data0-
17	CSI_D0P	CSI differential pairs data0+
18	GND	GND
19	CSI_D1M	CSI differential pairs data1-
20	CSI_D1P	CSI differential pairs data1+

2.3.9 Camera Interface

Figure 2-10 Camera Interface

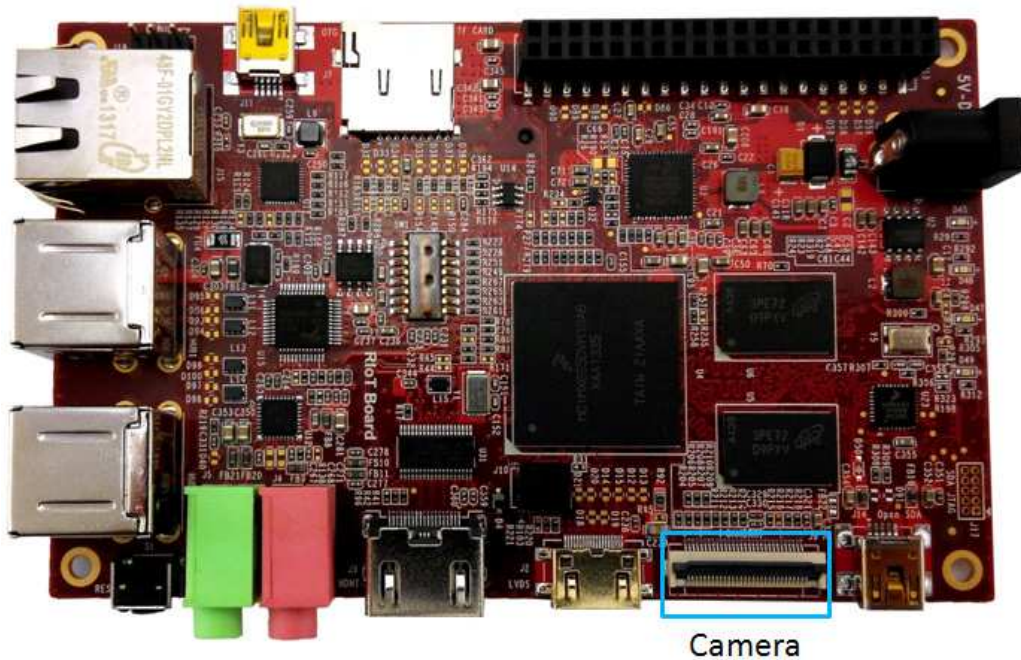

Table 2-9 Camera Interface

J9		
Pin	Signal	Function
1	GND	GND
2	NC	NC
3	NC	NC
4	CSIO_DAT12	CSIO capture data bit 12
5	CSIO_DAT13	CSIO capture data bit 13
6	CSIO_DAT14	CSIO capture data bit 14
7	CSIO_DAT15	CSIO capture data bit 15
8	CSIO_DAT16	CSIO capture data bit 16
9	CSIO_DAT17	CSIO capture data bit 17
10	CSIO_DAT18	CSIO capture data bit 18
11	CSIO_DAT19	CSIO capture data bit 19
12	NC	NC
13	NC	NC
14	GND	GND
15	CSIO_PIXCLK	CSIO pixel clock
16	GND	GND
17	CSIO_HSYNC	CSIO HSYNC
18	NC	NC
19	CSIO_VSYNC	CSIO VSYNC
20	VDD_NVCC	3.3V
21	CAM_MCLK	Camera clock
22	NC	NC
23	GND	GND
24	NC	NC
25	CAM_RST	CSIO reset
26	CAM_EN	CSIO data enable
27	I2C4_SDA	I2C2 serial data
28	I2C4_SCL	I2C2 serial clock
29	GND	GND
30	P1V8_SW4	1.8V

2.3.10 JTAG Interface

Figure 2-11 JTAG Interface

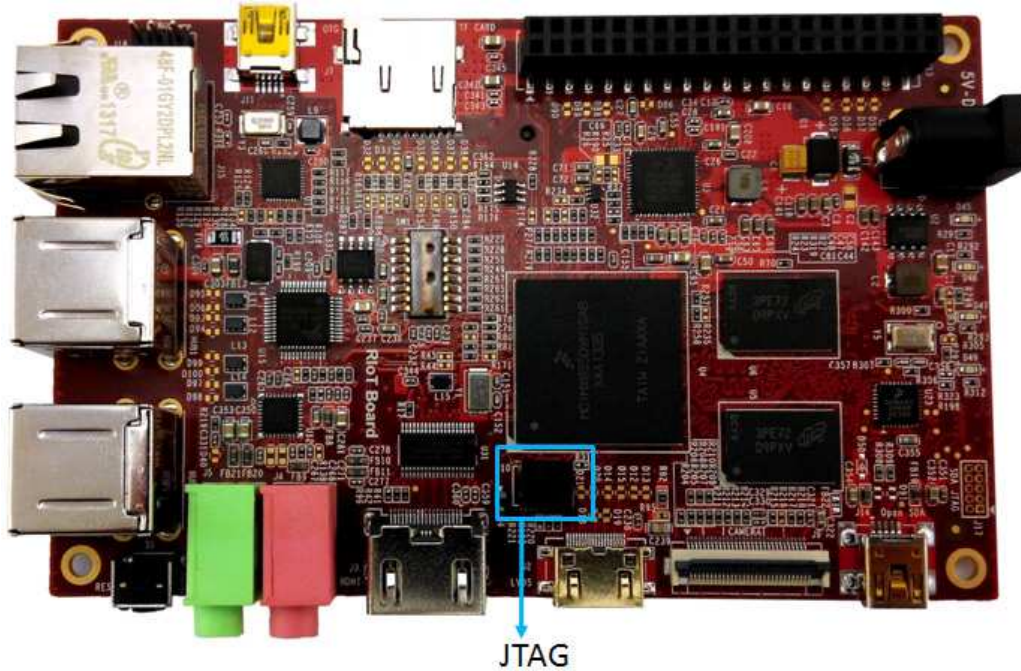

Table 2-10 JTAG Interface

J10		
Pin	Signal	Function
1	VDD_NVCC	3.3V
2	JTAG_TMS	Test mode select
3	GND	GND
4	JTAG_TCK	Test clock
5	GND	GND
6	JTAG_TDO	Test data output
7	JTAG_MOD	Test mode
8	JTAG_TDI	Test data input
9	JTAG_nTRST	Test system reset
10	RESET_N	Reset

2.3.11 Mini USB Interface

The mini USB connector is connected to the high-speed (HS) USB 2.0 OTG module of the i.MX 6Solo processor and is cross connected with the lower USB Host port on J3. When a 5V supply is seen on the mini USB connector (from the USB Host), the i.MX 6Solo processor will configure the OTG module to device mode, which will prevent the lower USB Host port from operating correctly.

Figure 2-12 Mini USB Interface

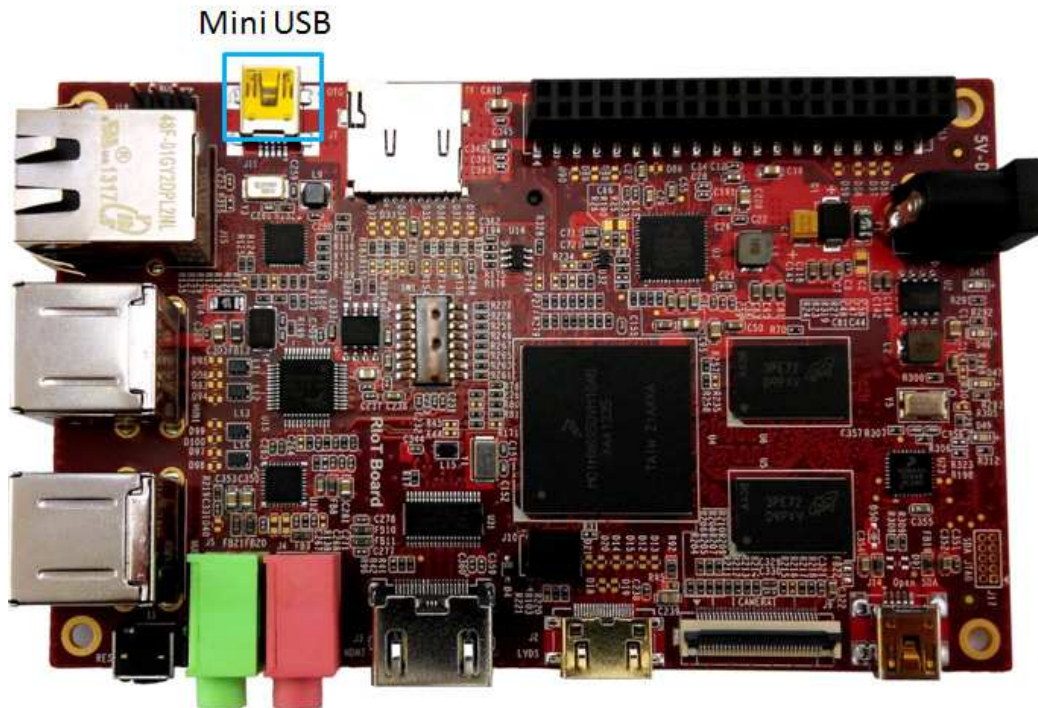

Table 2-11 Mini USB Interface

J11		
Pin	Signal	Function
1	USB_OTG_VBUS	+5V
2	USB_OTG_DN	USB data-
3	USB_OTG_DP	USB data+
4	USB_OTG_ID	USB ID
5	GND	GND

2.3.12 Serial Port

Figure 2-13 Serial Port

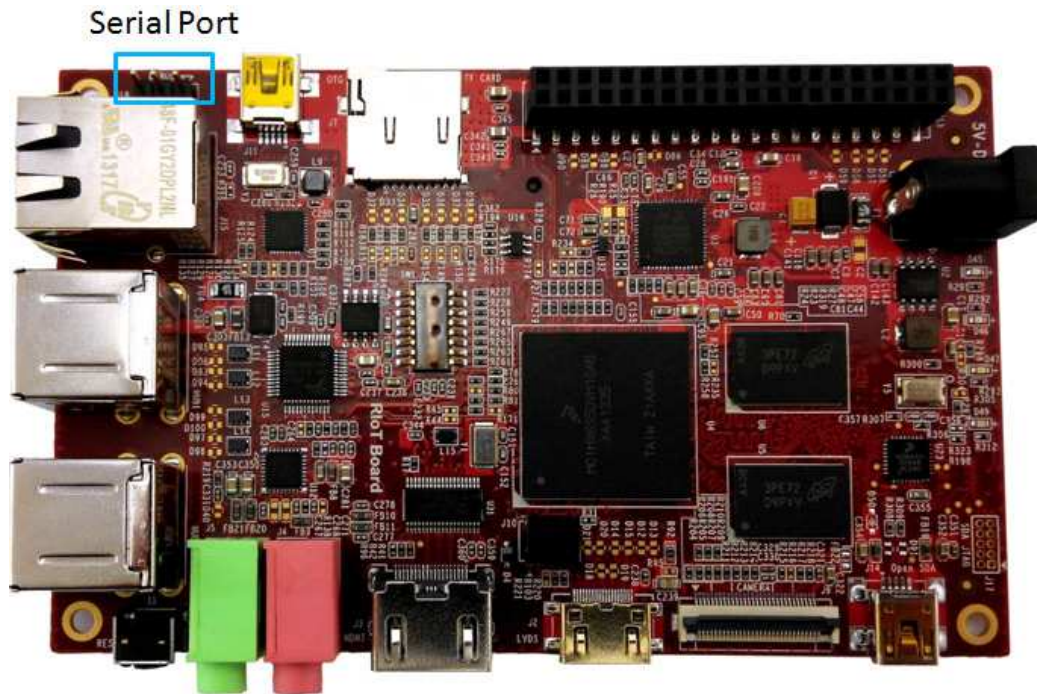

Table 2-12 Serial Port

J18		
Pin	Signal	Function
1	UART2_TXD	UART2 transmit data
2	UART2_RXD	UART2 receive data
3	GND	GND

2.3.13 Expansion Port Interface

Figure 2-14 Expansion Port

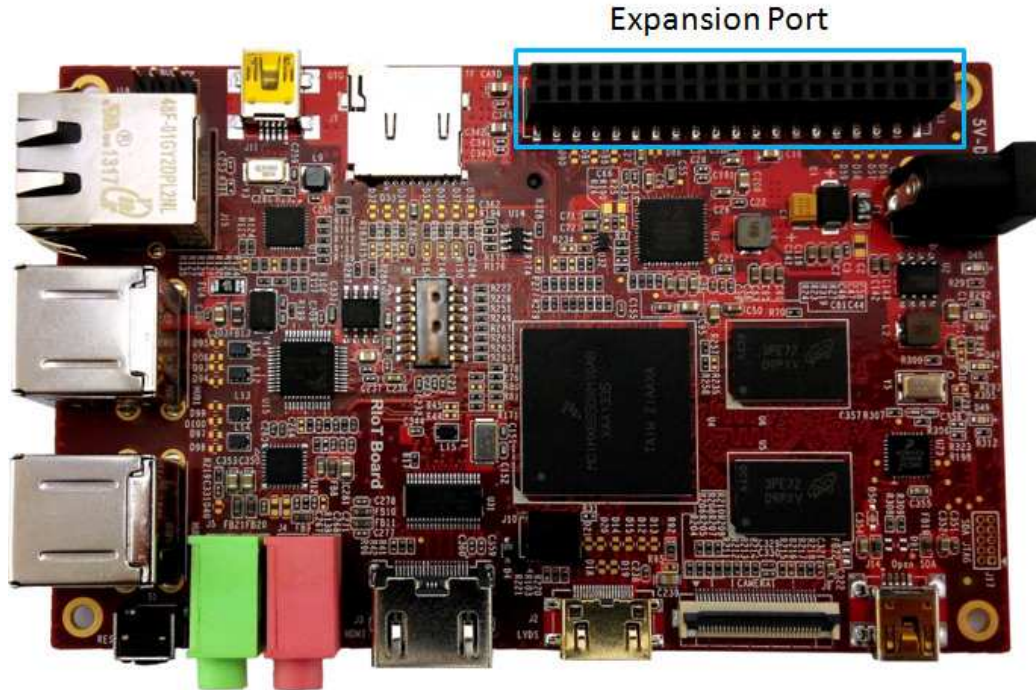

Table 2-13 Expansion Port Interface

J13		
Pin	Signal	Function
1	VDD_NVCC	3.3V
2	5VIN	5V
3	GND	GND
4	GND	GND
5	GPIO4_16	GPIO
6	CSPI3_CLK	SPI3 clock
7	GPIO4_17	GPIO
8	CSPI3_MOSI	SPI3 master output slave input
9	GPIO4_18	GPIO
10	CSPI3_MISO	SPI3 master input slave output
11	GPIO4_19	GPIO
12	CSPI3_CS0	SPI3 chip select 0
13	CSPI3_CS1	SPI3 chip select 1

14	CSPI2_CS1	SPI2 chip select 1
15	GPIO4_31	GPIO
16	CSPI2_MOSI	SPI2 master output slave input
17	GPIO5_05	GPIO
18	CSPI2_MISO	SPI2 master input slave output
19	GPIO5_06	GPIO
20	CSPI2_CS0	SPI2 chip select 0
21	GPIO5_07	GPIO
22	CSPI2_CLK	SPI2 clock
23	GPIO5_08	GPIO
24	UART3_RXD	UART3 receive data
25	GPIO4_26	GPIO
26	UART3_TXD	UART3 transmit data
27	GPIO4_27	GPIO
28	UART4_RXD	UART4 receive data
29	CSPI3_RDY	SPI3 data validation
30	UART4_TXD	UART4 transmit data
31	I2C3_SCL	I2C3 master serial clock
32	UART5_RXD	UART5 receive data
33	I2C3_SDA	I2C3 master serial data
34	UART5_TXD	UART5 transmit data
35	I2C4_SCL	I2C4 master serial clock
36	PWM1	Pulse Width Modulation
37	I2C4_SDA	I2C4 master serial data
38	PWM2	Pulse Width Modulation
39	GND	GND
40	PWM3	Pulse Width Modulation

2.3.14 Mini USB Interface (OpenSDA)

Figure 2-15 Mini USB (OpenSDA)Interface

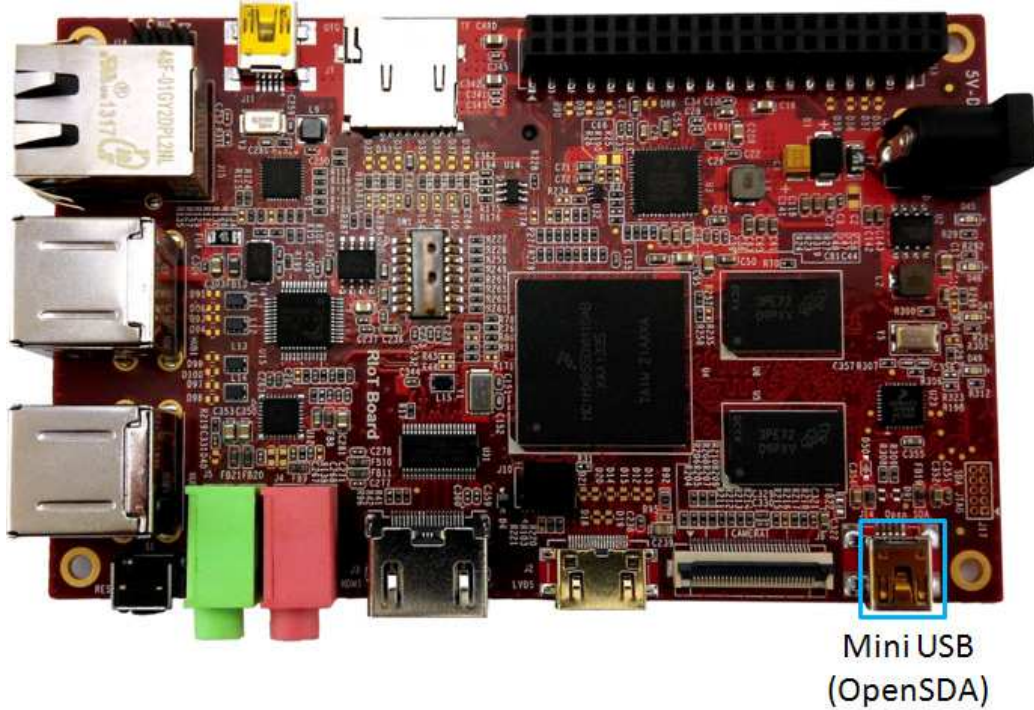



Table 2-14 Mini USB (OpenSDA) Interface

J14		
Pin	Signal	Function
1	V5V_SDA	+5V
2	SDA_USB_DN	SDA USB data-
3	SDA_USB_DP	SDA USB data+
4	NC	NC
5	GND	GND

Note:

 The RIoTboard has hardware to support Freescale's OpenSDA interface. Currently this interface has not been enabled in software

2.3.15 RGMII LAN Interface

The Ethernet connector contains integrated magnetic which allows the Ethernet IC to auto configure the port for the correct connection to either a switch or directly to a host PC on a peer-to-peer network. It is not necessary to use a crossover cable when connecting directly to another computer. The Ethernet connector is shown in Figure 2-16.

Figure 2-16 RGMII LAN Interface

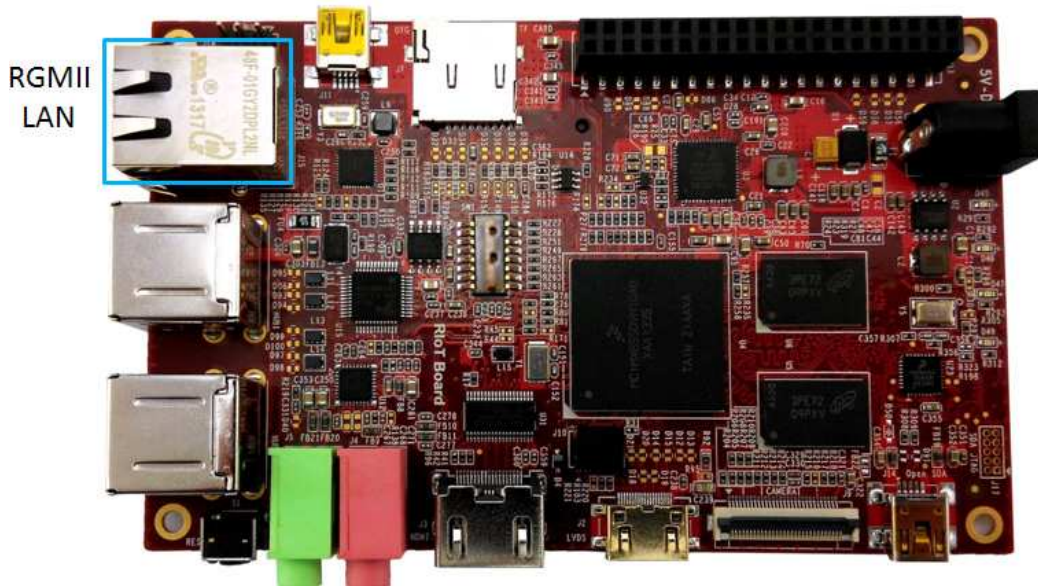

Table 2-15 RGMII LAN interface

J15		
Pin	Signal	Function
1	TD1+	TD1+ output
2	TD1-	TD1- output
3	TD2+	TD2+ output
4	TD2-	TD2- output
5	TCT	2.5V power for TD
6	RCT	2.5V power for RD
7	RD1+	RD1+ input
8	RD1-	RD1- input
9	RD2+	RD2+ input
10	RD2-	RD2- input

11	GRLA	Green LED link signal
12	GRLC	Power supply for green LED
13	YELC	Yellow LED action signal
14	YELA	Power supply for yellow LED

2.3.16 USB HUB Interface

Figure 2-17 USB Host Interface

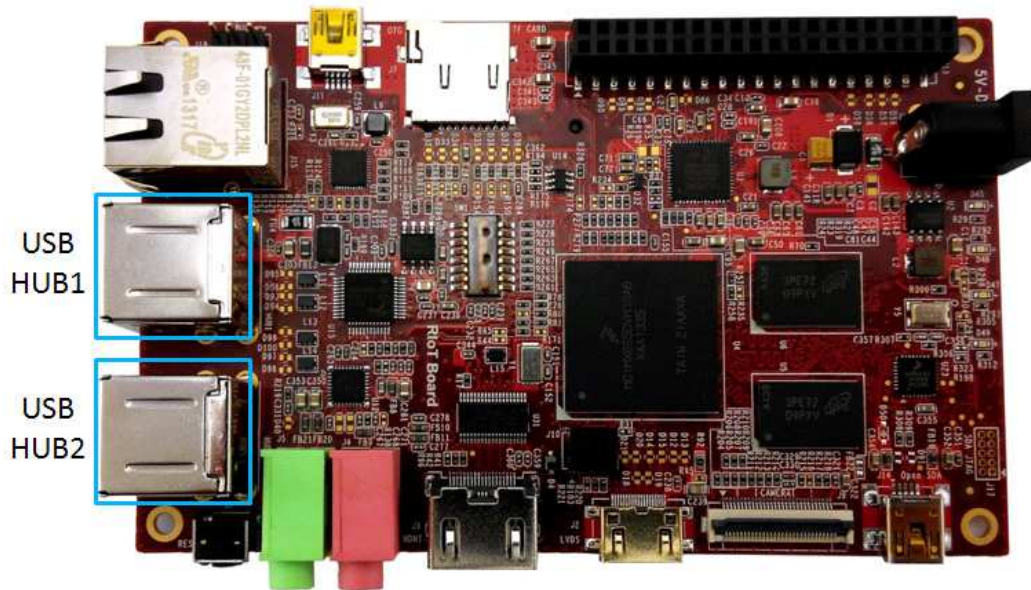

Table 2-16 USB Host Interface

HUB1		
Pin	Signal	Function
1	USB_PWR3	+5V
2	USB_DM3	USB data-
3	USB_DP3	USB data+
4	GND	GND
5	USB_PWR4	+5V
6	USB_DM4	USB data-
7	USB_DP4	USB data+
8	GND	GND

HUB2		
Pin	Signal	Function
1	USB_PWR1	+5V
2	USB_DM1	USB data-
3	USB_DP1	USB data+
4	GND	GND
5	USB_PWR2	+5V
6	USB_DM2	USB data-
7	USB_DP2	USB data+
8	GND	GND

2.3.17 Boot Configuration Select

Figure 2-18 Boot Configuration Select

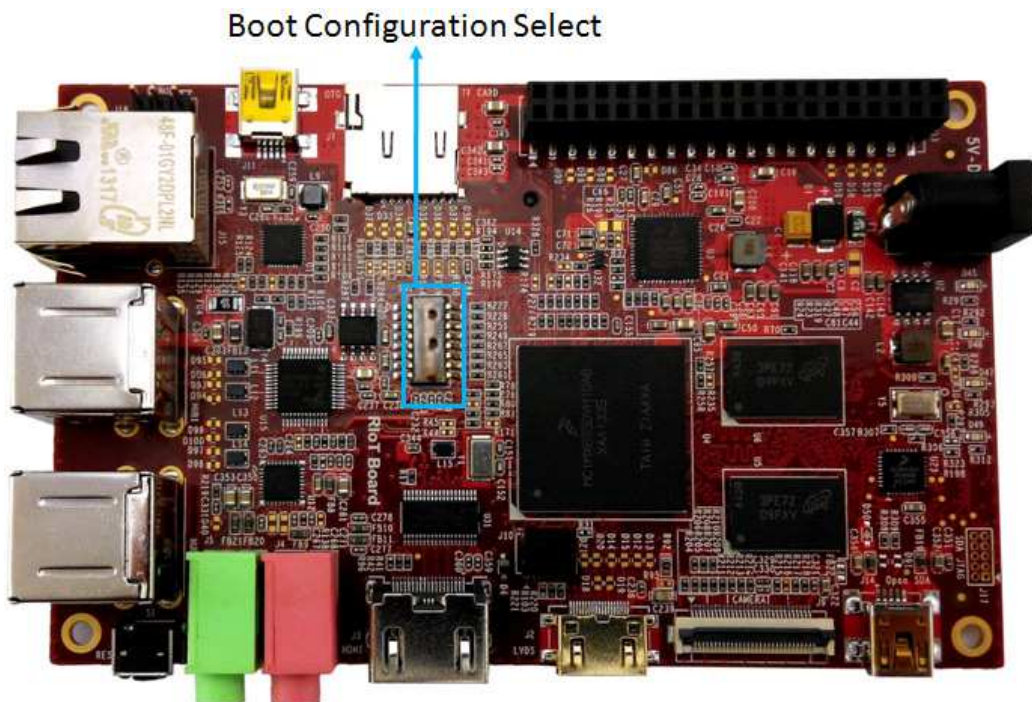

Table 2-17 Boot Configuration Select

SW1		
Pin	Signal	Function
1	P3V0_STBY	P3V0_STBY
2	P3V0_STBY	P3V0_STBY
3	VDD_NVCC	VDD_NVCC
4	VDD_NVCC	VDD_NVCC
5	VDD_NVCC	VDD_NVCC
6	VDD_NVCC	VDD_NVCC
7	VDD_NVCC	VDD_NVCC
8	VDD_NVCC	VDD_NVCC
9	EIM_DA11	BT_CFG2_3
10	EIM_DA12	BT_CFG2_4
11	EIM_DA13	BT_CFG2_5
12	EIM_DA14	BT_CFG2_6
13	EIM_DA5	BT_CFG1_5
14	EIM_DA6	BT_CFG1_6
15	BOOT_MODE0	BOOT_MODE0
16	BOOT_MODE1	BOOT_MODE1

2.3.18 Reset Switch

Figure 2-19 Reset Switch

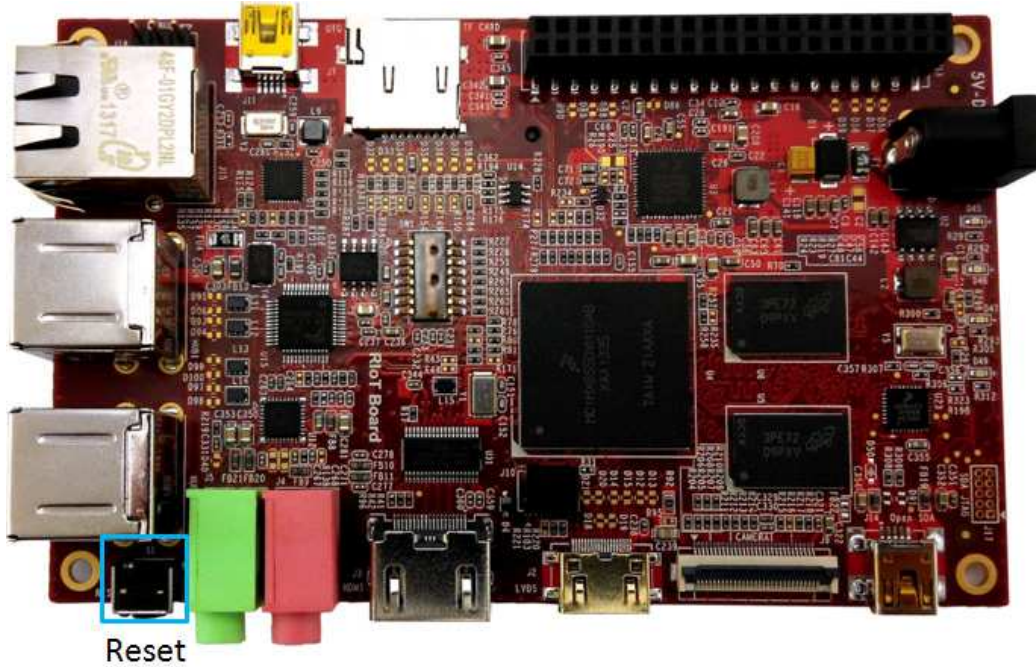

Table 2-18 Reset Switch

S1		
Pin	Signal	Function
1	GND	GND
2	POR_B	System reset
3	NC	NC
4	NC	NC

2.3.19 LEDs

Figure 2-20 LEDs

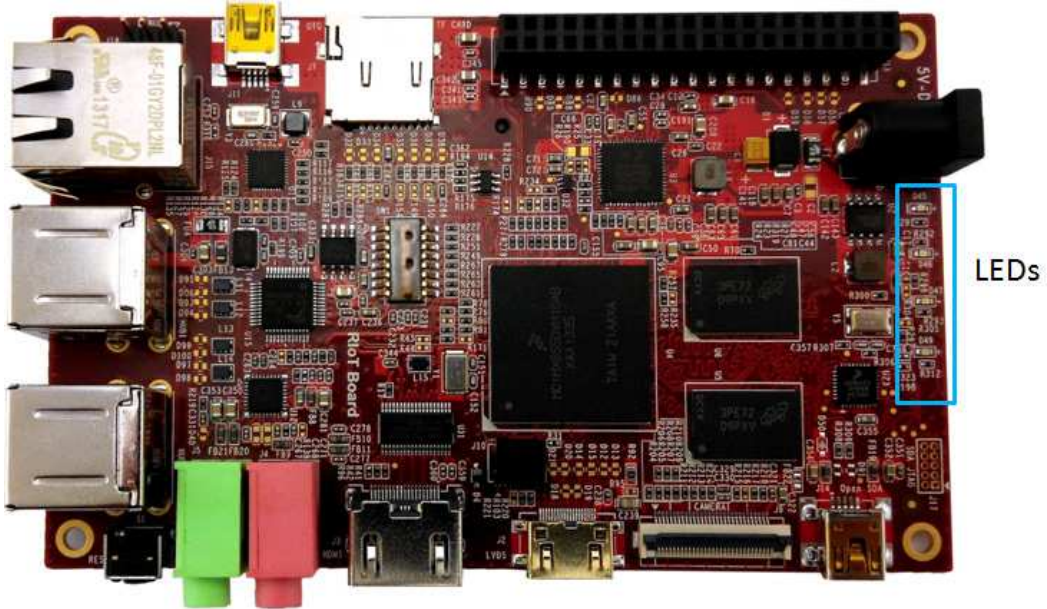

Table 2-19 LEDs

LED	
Reference	Function
D45	User-defined LED
D46	User-defined LED
D47	Power LED
D49	OpenSDA LED

3 Getting Started

Before you start to use RIoTboard, please read the following sections to get yourself familiar with the system images, driver code and tools which might be involved during development process.

NOTE: All images and tools for Android and Linux can be downloaded from www.element14.com/riotboard

3.1 Software Features

The table shown below lists the versions of Linux and Android systems, as well as the device drivers.

Table 3-1 OS and Drivers

Types		Notes
OS	Linux	Version 3.0.35
	Ubuntu	Version 11.10
	Android	Version 4.3
Device Drivers	Serial	Series driver
	RTC	Hardware clock driver
	Net	10/100/Gb IEEE1588 Ethernet
	Display	Two display ports (LVDS, and HDMI 1.4a)
	MMC/SD	Two SD 3.0/SDXC card slot & eMMC
	USB	5 High speed USB ports (4xHost, 1xOTG)
	Audio	Analog (headphone & mic) and Digital (HDMI)
	Camera	Two camera ports (1xParallel, 1x MIPI CSI-2)
LED	User leds driver	

3.2 Linux System

The following tables list the specific images and eMMC storage partitions required to build a Linux system.

Table 3-2 Images Required by Linux

Images	Paths
u-boot image	u-boot-mx6solo-riot.bin
kernel image	ulmage
rootfs image	oneirc.tgz

Table 3-3 Storage Partitions for Linux

Partition type/index	Name	Start Offset	Size	File System	Content
N/A	BOOT Loader	0	1MB	N/A	u-boot-mx6solo-riot.bin
N/A	Kernel	1M	9MB	N/A	ulmage
Primary 1	Rootfs	10M	Total - Other	EXT3	oneiric.tgz

- **Partition type/index:** defined in MBR.
- **Name:** only meaningful in Android. You can ignore it when creating these partitions.
- **Start Offset:** shows where partition starts with unit in MB.

3.3 Android System

The following tables list the specific images and eMMC storage partitions required to build an Android system.

Table 3-4 Images Required by Android

Images	Paths
u-boot image	u-boot-mx6solo-riot.bin
boot image	boot.img
Android system root image	system.img
Recovery root image	recovery.img

Table 3-5 Storage Partitions for Android

Partition type/index	Name	Start Offset	Size	File System	Content
N/A	BOOT Loader	0	1MB	N/A	bootloader
Primary 1	Boot	8M	8MB	boot.img format, a kernel + ramdisk	boot.img
Primary 2	Recovery	Follow Boot	8MB	boot.img format, a kernel + ramdisk	recovery.img
Logic 4 (Extended 3)	DATA	follow Recovery	> 1024MB	EXT4 Mount at /data	Application data storage for system application.
Logic 5 (Extended 3)	SYSTEM	Follow DATA	512MB	EXT4. Mount as /system	Android system files under /system/ dir
Logic 6 (Extended 3)	CACHE	follow SYSTEM	512MB	EXT4. Mount as /cache	Android cache, for image store for OTA
Logic 7(Extended 3)	VENDOR	follow CACHE	8MB	Ext4 Mount at /device	For Store MAC address files.
Logic 9 (Extended 3)	Misc	Follow DATA	8M	N/A	For recovery store bootloader message, reserve.
Primary 4	MEDIA	Follow Misc	Total - Other	VFAT	For internal media

Partition type/index	Name	Start Offset	Size	File System	Content
			images		partition, in /mnt/sdcard/ dir.

- **SYSTEM Partition:** used to store Android system image.
- **DATA Partition:** used to store applications' unpacked data, system configuration database, etc.

Under normal mode, the root file system is mounted from uramdisk. Under recovery mode, the root file system is mounted from the RECOVERY partition.

3.4 Setting up Terminal Emulation

Connect the RIoTboard to a PC with the help of a serial cable. Launch a terminal emulation program such as HyperTerminal or TeraTerm and configure the COM parameters as show below.

Figure 3-1 COM Properties

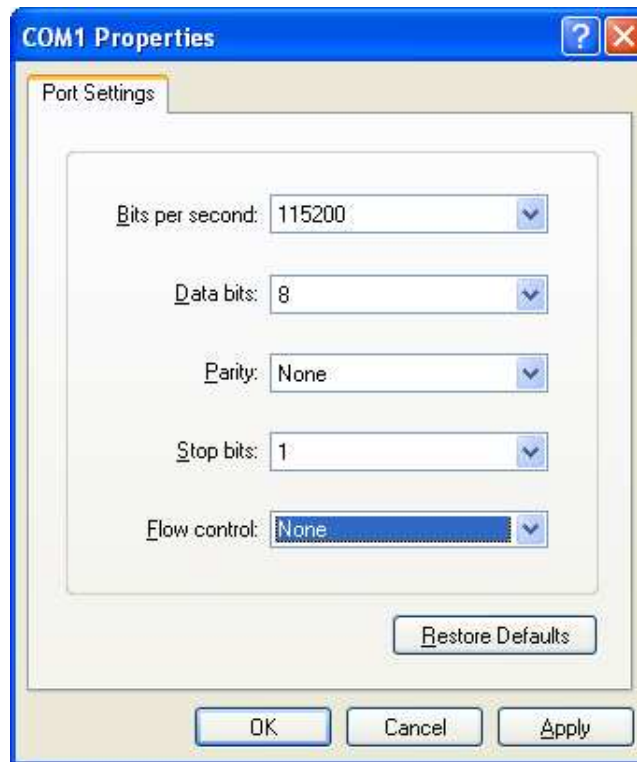

4 Downloading and Running the System

Now you can download the existing system to the RIoTboard and run it. The MFG tool saved under `linux\tools\ & android\tools\` will be used to download images.

NOTE: All images and tools for Android and Linux can be downloaded from www.element14.com/riotboard

4.1 Download and Run Linux or Android System

- 1) Copy all the system files to a root directory of your hard drive (assume C:\ is the root directory).
- 2) Use a Mini USB cable to connect USB OTG interface on RIoTboard to the USB Host on PC, and then open a Terminal window;
- 3) Set the boot switch SW1 on the RIoTboard to **Serial Download Mode** according to the configurations as shown in the following table;

Table 4-1 Boot Switch Configuration – Serial Download

Switch	D1	D2	D3	D4	D5	D6	D7	D8
SW1	OFF	ON	ON	ON	OFF	ON	ON	ON

Figure 4-1 Boot Configuration Switch

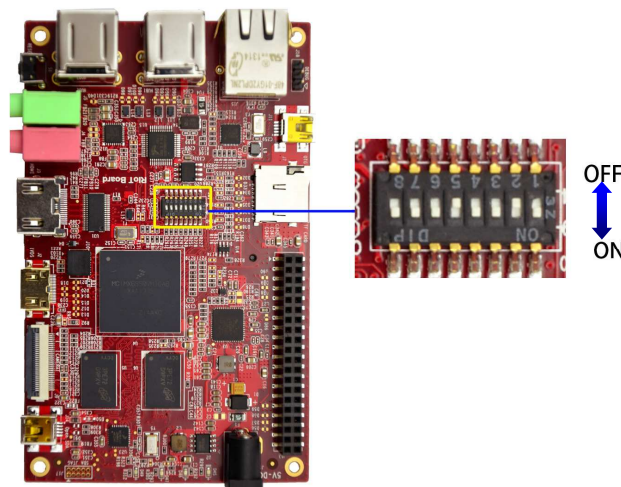

4) Modify the MFG tool configuration

Currently the Linux system on the RIoTboard supports only booting from eMMC, but the Android system supports booting from both eMMC and SD card. To select the device you want to program to, follow the instruction below:

Modify the value of "name" in `cfg.ini` under Android flash image tool **Mfgtools-Rel-4.1.0_130816_MX6DL_UPDATER** directory.

```
eMMC    --    name = Android-RIOT-eMMC
SD      --    name = Android-RIOT-SD
```

5) Prepare the image files

For Linux: Copy the Linux image files `oneiric.tgz`, `u-boot-mx6solo-riot.bin` and `ulmage` to the Linux flash image tool **Mfgtools-Rel-4.1.0_130816_MX6DL_UPDATER\Profiles\MX6DL Linux Update\OS Firmware\files** to overwrite the files with the same names

For Android: Copy the Android image files: `u-boot-mx6solo-riot.bin` and according to the boot mode (SD/eMMC) to copy the `boot.img`, `recovery.img` and `system.img` under SD/eMMC directory to Android flash image tool **Mfgtools-Rel-4.1.0_130816_MX6DL_UPDATER\Profiles\MX6DL Linux Update\OS Firmware\files\android**, for overwriting the files with the same names

6) According to the system you want to boot, run the corresponding MFG tool on your PC and power up the RIoTboard; the software window is shown below; (the PC will install HID driver automatically if it is the first time connecting to the RIoTboard)

For Linux system, the MFG tool is located at :

`linux\tools\Mfgtools-Rel-4.1.0_130816_MX6DL_UPDATER;`

For Android system, the MFG tool is located at :

`android\tools\Mfgtools-Rel-4.1.0_130816_MX6DL_UPDATER;`

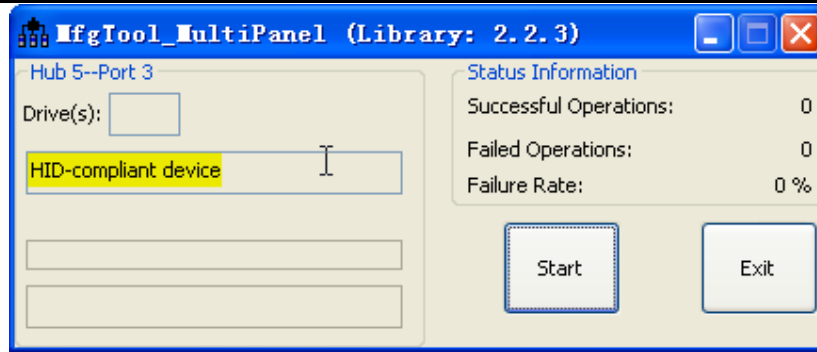

MFG tool window

- 7) Click **Start** in the following window; when download process is done, click **Stop** to finish.

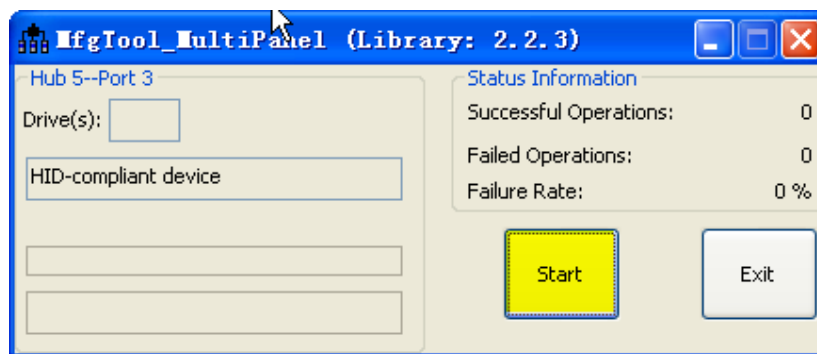

Click Start

- 8) When download process is done, click **Exit** to exit.

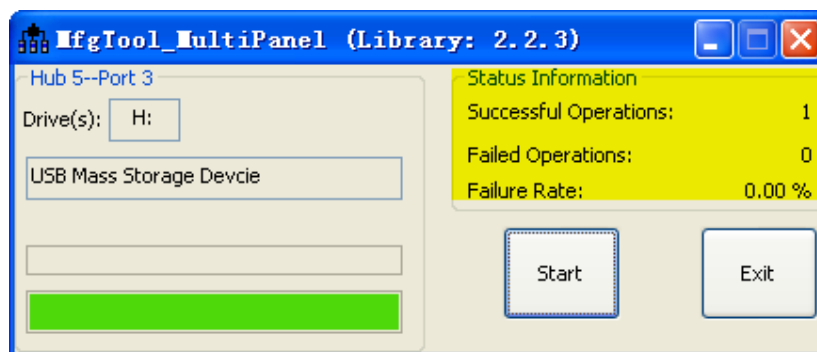

- 9) Power off the RIoTboard and set the boot switches SW1 on it to eMMC boot mode according to the configuration as shown in the following table;

Table 4-2 Boot Switch Configuration - eMMC

Switch	D1	D2	D3	D4	D5	D6	D7	D8
SW1	ON	OFF	ON	ON	OFF	ON	ON	ON

Table 4-3 Boot Switch Configuration – SD

Switch	D1	D2	D3	D4	D5	D6	D7	D8
SW1	ON	OFF	ON	OFF	OFF	ON	OFF	ON

After the switch is set, power up the RIoTboard to boot the system.

4.2 Display Mode Configurations for Linux & Android Systems

The system supports multiple display modes. Users can select an appropriate mode by configuring u-boot parameters.

Please reboot the RIOT Board and press any key on your PC's keyboard when the system prompts you with a countdown in seconds as shown below:

```

U-Boot 2009.08-dirty (Oct 17 2013 - 17:08:06)

CPU: Freescale i.MX6 family TO1.1 at 792 MHz
Thermal sensor with ratio = 201
Temperature: 42 C, calibration data 0x5f55765f
mx6q pll1: 792MHz
mx6q pll2: 528MHz
mx6q pll3: 480MHz
mx6q pll8: 50MHz
ipg clock : 66000000Hz
ipg per clock : 66000000Hz
uart clock : 80000000Hz
cspi clock : 60000000Hz
ahb clock : 132000000Hz
axi clock : 198000000Hz
emi_slow clock: 99000000Hz
ddr clock : 396000000Hz
usdhc1 clock : 198000000Hz
usdhc2 clock : 198000000Hz
usdhc3 clock : 198000000Hz
usdhc4 clock : 198000000Hz
nfc clock : 24000000Hz
Board: i.MX6DL/Solo-SABRESD: unknown-board Board: 0x61011 [POR ]
Boot Device: MMC
I2C: ready
DRAM: 1 GB
MMC: FSL_USDHC: 0,FSL_USDHC: 1,FSL_USDHC: 2,FSL_USDHC: 3
In: serial
Out: serial
Err: serial
  
```



```
Net: got MAC address from IIM: 00:00:00:00:00:00
----enet_board_init: phy reset
FECO [PRIME]
Hit any key to stop autoboot: 0 ( press any key to enter u-boot command mode )
MX6Solo RIOT U-Boot >
```

1) Display with 9.7" LVDS Only

Execute the following instructions in u-boot mode to configure for 9.7-inch display mode;

- MX6Solo RIOT U-Boot > **setenv bootargs console=ttymxc1,115200
init=/init nosmp video=mxcfb0:dev=ldb,bpp=32 video=mxcfb1:off
fbmem=10M vmalloc=400M androidboot.console=ttymxc1
androidboot.hardware=freescale**
- MX6Solo RIOT U-Boot > **saveenv**

2) Display with HDMI Only (Default mode)



Execute the following instructions in u-boot mode to configure for HDMI display mode;

- MX6Solo RIOT U-Boot > **setenv bootargs console=ttymxc1,115200
init=/init nosmp video=mxcfb0:dev=hdmi,1280x720M@60,bpp=32
video=mxcfb1:off fbmem=10M vmalloc=400M
androidboot.console=ttymxc1 androidboot.hardware=freescale**
- MX6Solo RIOT U-Boot > **saveenv**

5 Making Images

This Chapter will introduce how to make images by using BSP contained in the ISO. The BSP is a collection of binary, source code, and support files that can be used to create a u-boot bootloader, Linux kernel image, and Android file system for i.MX 6Solo RIOT Board.

Note:

-  The following instructions are all executed under Ubuntu system.
-  Each instruction has been put a bullets “•” before it to prevent confusion caused by the long instructions that occupy more than one line in the context.

5.1 Making Images for Linux

Please strictly follow the steps listed below to make images for Linux system.

5.1.1 Getting Tools and Source Code

- 1) Execute the following instructions to get cross compiling toolchain;
 - `$ cd ~`
 - `$ git clone git://github.com/embedest-tech/fsl-linaro-toolchain.git`
- 2) Execute the following instructions to get u-boot source code;
 - `$ cd ~`
 - `$ git clone git://github.com/embedest-tech/u-boot-imx.git -b embedest_imx_3.0.35_4.0.0`
- 3) Execute the following instructions to get kernel source code;
 - `$ cd ~`
 - `$ git clone git://github.com/embedest-tech/linux-imx.git -b embedest_imx_3.0.35_4.0.0`

5.1.2 Compiling System Images

- 1) Execute the following instructions to compile u-boot image;
 - `$ cd ~ /u-boot-imx`
 - `$ export ARCH=arm`
 - `$ export CROSS_COMPILE=~ /fsl-linaro-toolchain/bin/arm-fsl-linux-gnueabi-`
 - `$ make distclean`
 - `$ make mx6solo_riot_config`

- `$ make`
- `$ mv u-boot.bin u-boot-mx6solo-riot.bin`

After executing the instructions, a file `u-boot-mx6solo-riot.bin` can be found in the current directory ;

2) Execute the following instructions to compile kernel image;

- `$ export PATH=~ /u-boot-imx/tools:$PATH`
- `$ cd ~/linux-imx`
- `$ export ARCH=arm`
- `$ export CROSS_COMPILE=~ / fsl-linaro-toolchain/bin/arm-fsl-linux-gnueabi-`
- `$ make imx6_defconfig`
- `$ make ulmage`

After executing the instructions, a kernel image named `ulmage` can be found under `arch/arm/boot/`.

Note:

The `mkimage` is used to build the kernel and ramfs images are automatically generated and saved under `tools/` after compiling `u-boot.bin`. So please make sure `uboot` is compiled first before compiling kernel image.



Copy `u-boot-mx6solo-riot.bin` and `ulmage` files that are generated by compiling to **linux flash image tool Mfgtools-Rel-4.1.0_130816_MX6DL_UPDATER\ Profiles\MX6DL Linux Update\OS Firmware\files** to overwrite the files with the same names and then start over the operations from step 2) in section 4.1 to verify the Linux system built.

5.2 Making Images for an Android System

Please strictly follow the steps listed below to make images for Android system.

5.2.1 Getting Repo Source Code

1) Execute the following instructions to get repo tool;

- `$ mkdir ~/bin`
- `$ curl https://raw.githubusercontent.com/android/tools_repo/stable/repo > ~/bin/repo`
- `$ chmod a+x ~/bin/repo`
- `$ export PATH=~ /bin:$PATH`

2) Execute the following instructions to initialize repo source code;

- \$ **mkdir ~/android-imx6-jb4.3-1.0.0**
- \$ **cd ~/android-imx6-jb4.3-1.0.0**
- \$ **repo init --repo-url=git://github.com/android/tools_repo.git -u git://github.com/embest-tech/imx-manifest.git -m embest_android_jb4.3_1.0.0**

3) Execute the following instructions to synchronize repo source code;

- \$ **cd ~/android-imx6-jb4.3-1.0.0**
- \$ **repo sync**

5.2.2 Compiling System Images

1) You can choose to build Android image for eMMC or SD Boot:

Open the “device/fsl/riot_6solo/BoardConfig.mk” file with Notepad; change the “BUILD_TARGET_LOCATION” to select the boot device :

- eMMC Boot -- BUILD_TARGET_LOCATION ?= emmc
- SD Boot -- BUILD_TARGET_LOCATION ?= sdmmc

2) Execute the following instructions to compile Android image;

- \$ **cd ~/android-imx6-jb4.3-1.0.0**
- \$ **source build/envsetup.sh**
- \$ **lunch riot_6solo-user**
- \$ **make clean**
- \$ **make**



After executing the instructions, the generated images can be found under `android-imx6-jb4.3-1.0.0/out/target/product/riot_6solo/`;

Table 5-1 shown below lists all the images and directories after compilation is completed.

Table 5-1 Images and Directories

Images/Directories	Notes
root/	root file system, mounted at /
system/	Android system directory, mounted at /system
data/	Android data area. mounted at /data
recovery/	Root filesystem when booting in "recovery" mode, not used directly
boot.img	A composite image which includes the kernel zImage, ramdisk, and boot parameters
ramdisk.img	Ramdisk image generated from "root/", not directly used
system.img	EXT4 image generated from "system/". Can be written to "SYSTEM" partition of SD/eMMC card with "dd" command
userdata.img	EXT4 image generated from "data/"
recovery.img	EXT4 image generated from "recovery/". Can be written to "RECOVERY" partition of SD/eMMC card with "dd" command
u-boot.bin	uboot image with padding

Note:

-  Android image should be built in user mode;
-  For more information, please visit <http://source.android.com/source/building.html>

3) Execute the following instructions to compile boot.img;

- **\$ source build/envsetup.sh**
- **\$ lunch riot_6solo-user**
- **\$ make bootimage**

After executing the instructions, a boot.img image can be found under android-imx6-jb4.3-1.0.0/out/target/product/riot_6solo/.

Note:

-  Copy the *boot.img*, *recovery.img*, *system.img* and *u-boot.bin* (**rename this to u-boot-mx6solo-riot.bin**) files created upon compilation, to the Android flash tool folder **Mfgtools-Rel-4.1.0_130816_MX6DL_UPDATER\ Profiles\MX6DL Linux Update\OS Firmware\files\android** to overwrite the files with the same names and repeat the operations from step 2) in 4.1 to verify the Android system built.

6 ESD PRECAUTIONS AND PROPER HANDLING PROCEDURES

This section includes the precautions for mechanical handling and static precautions to be taken to avoid ESD damage:

- Avoid carpets in cool, dry areas. Leave development kits in their anti-static packaging until ready to be installed.
- Dissipate static electricity before handling any system components (development kits) by touching a grounded metal object, such as the system unit unpainted metal chassis.
- If possible, use antistatic devices, such as wrist straps and floor mats.
- Always hold a evaluation board by its edges. Avoid touching the contacts and components on the board.
- Take care when connecting or disconnecting cables. A damaged cable can cause a short in the electrical circuit.
- Prevent damage to the connectors by aligning connector pins before you connect the cable. Misaligned connector pins can cause damage to system components at power-on.
- When disconnecting a cable, always pull on the cable connector or strain-relief loop, not on the cable itself.

