

SAMSUNG

SM-V700

User Manual

About this manual

You can use this device as a companion device to some Samsung Android™ smartphones or tablet PCs. This user manual is specially designed to explain applications and features that are available when the device is connected to a mobile device.

- Please read this manual before using the device to ensure safe and proper use.
- Descriptions are based on the device's default settings.
- Images and screenshots may differ in appearance from the actual product.
- Content may differ from the final product, or from software provided by service providers or carriers, and is subject to change without prior notice. For the latest version of the manual, refer to the Samsung website, www.samsung.com.
- Content (high quality content) that requires high CPU and RAM usage will affect the overall performance of the device. Applications related to the content may not work properly depending on the device's specifications and the environment that it is used in.
- Available features and additional services may vary by device, software, or service provider.
- Applications and their functions may vary by country, region, or hardware specifications. Samsung is not liable for performance issues caused by applications from any provider other than Samsung.
- Samsung is not liable for performance issues or incompatibilities caused by edited registry settings or modified operating system software. Attempting to customise the operating system may cause the device or applications to work improperly.
- Software, sound sources, wallpapers, images, and other media provided with this device are licensed for limited use. Extracting and using these materials for commercial or other purposes is an infringement of copyright laws. Users are entirely responsible for illegal use of media.
- Default applications that come with the device are subject to updates and may no longer be supported without prior notice. If you have questions about an application provided with the device, contact a Samsung Service Centre. For user-installed applications, contact service providers.
- Modifying the device's operating system or installing softwares from unofficial sources may result in device malfunctions and data corruption or loss. These actions are violations of your Samsung licence agreement and will void your warranty.

Instructional icons



Warning: situations that could cause injury to yourself or others



Caution: situations that could cause damage to your device or other equipment



Note: notes, usage tips, or additional information

Copyright

Copyright © 2013 Samsung Electronics

This guide is protected under international copyright laws.

No part of this guide may be reproduced, distributed, translated, or transmitted in any form or by any means, electronic or mechanical, including photocopying, recording, or storing in any information storage and retrieval system, without the prior written permission of Samsung Electronics.

Trademarks

- SAMSUNG and the SAMSUNG logo are registered trademarks of Samsung Electronics.
- Bluetooth® is a registered trademark of Bluetooth SIG, Inc. worldwide.
- All other trademarks and copyrights are the property of their respective owners.

Table of Contents

Getting started

- 6 Device layout
- 7 Button
- 7 Package contents
- 8 Charging the battery
- 11 Wearing the device
- 12 Turning the device on and off
- 13 Connecting to a mobile device
- 14 Locking and unlocking the device
- 14 Adjusting the brightness of the display
- 15 Adjusting the volume
- 15 Switching to silent mode

Basics

- 16 Indicator icons
- 16 Using the touch screen
- 19 Notifications
- 20 Home screen
- 21 Clock screen
- 21 Applications screen
- 21 Using applications
- 22 Returning to the previous screen
- 22 Securing the device
- 23 Bluetooth
- 24 Using calling features

Gear Manager

- 25 About Gear Manager
- 25 Configuring the device settings
- 25 Customising the Home screen
- 26 Managing applications
- 27 Finding the device
- 27 Activating the auto lock feature
- 27 Activating the notification features
- 28 Setting an application shortcut
- 28 Setting up emergency messages
- 28 Smart relay
- 29 Using a wake-up gesture
- 29 Viewing help information

Applications

- 30 Camera
- 32 Gallery
- 33 Archive
- 33 Contacts
- 33 Dialler
- 33 Find my device
- 34 Logs
- 34 Media Controller
- 35 Pedometer
- 38 S Voice
- 38 Stopwatch

- 39 Timer
- 39 Today's Schedule
- 39 Voice Memo
- 40 Weather

Settings

- 41 About Settings
- 41 Clock
- 42 Sound
- 42 Volume
- 42 Display
- 43 Bluetooth
- 43 Privacy lock
- 43 Language
- 43 Reset Gear
- 43 Gear info

Troubleshooting

Getting started

Device layout

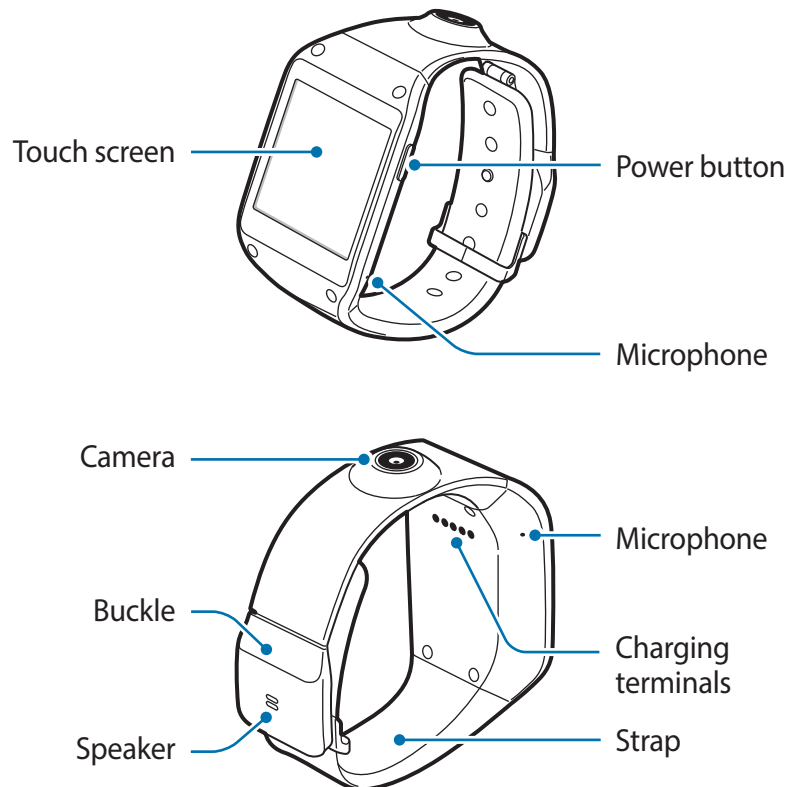

Humidity and liquids may damage your device. Keep your device dry.



- Do not use a screen protector. This causes sensor malfunctions.
- Do not allow water to contact the touch screen. The touch screen may malfunction in humid conditions or when exposed to water.
- If the speaker is wet, sound may be distorted. Ensure that the speaker is dry.

Button

Button	Function
 Power	<ul style="list-style-type: none">• Press and hold to turn the device on or off.• Press and hold for 8-10 seconds to reset the device if it has fatal errors or hang-ups, or freezes.• Press to return to the Clock screen.• Press to lock the device on the Clock screen. The device goes into lock mode when the touch screen turns off. Press again to unlock the device.

Package contents

Check the product box for the following items:

- Device
- Charging cradle
- Quick start guide



- The items supplied with the device and any available accessories may vary depending on the region or service provider.
- The supplied items are designed only for this device and may not be compatible with other devices.
- Appearances and specifications are subject to change without prior notice.
- You can purchase additional accessories from your local Samsung retailer. Make sure they are compatible with the device before purchase.
- Other accessories may not be compatible with your device.
- Use only Samsung-approved accessories. Malfunctions caused by using unapproved accessories are not covered by the warranty service.
- Availability of all accessories is subject to change depending entirely on manufacturing companies. For more information about available accessories, refer to the Samsung website.

Charging the battery

Use the charging cradle to charge the battery before using it for the first time. A computer can be also used to charge the device by connecting them via the USB cable.



Use only Samsung-approved chargers, batteries, and cables. Unapproved chargers or cables can cause the battery to explode or damage the device.



- When the battery power is low, the battery icon appears empty.
- If the battery is completely discharged, the device cannot be turned on immediately when the charger is connected. Allow a depleted battery to charge for a few minutes before turning on the device.

Charging with the charging cradle

- 1 Slide and hold the switch, and then open the cover of the charging cradle.

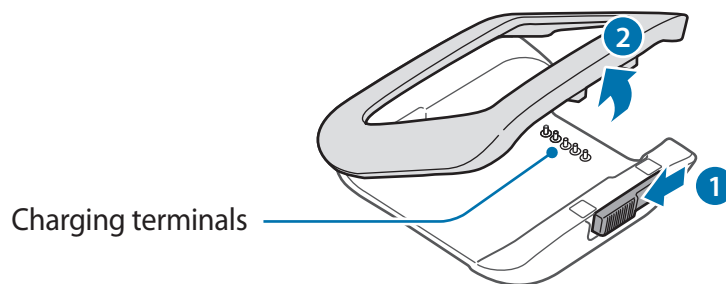

- 2 Place the device on the charging cradle with the charging terminals facing each other.

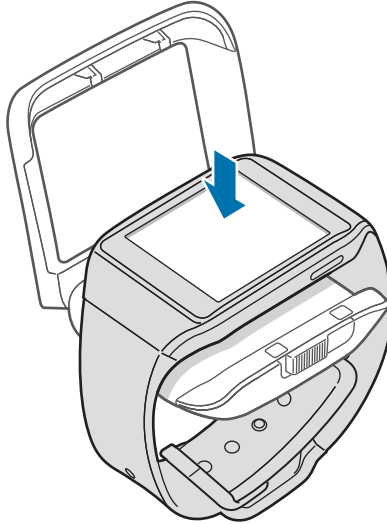

- 3 Close the cover of the charging cradle.

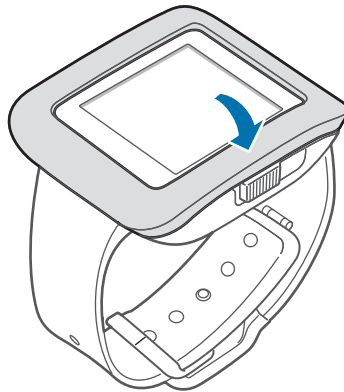

- 4 Plug the small end of the charger into the multipurpose jack of the charging cradle, and plug the large end of the charger into an electric socket.

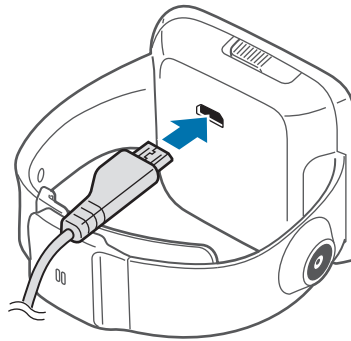

Connecting the charger improperly may cause serious damage to the device. Any damage caused by misuse is not covered by the warranty.



- While charging, you cannot answer calls and use voice recorder and camera.
- If the device receives an unstable power supply while charging, the touch screen may not function. If this happens, unplug the charger from the device.
- While charging, the device may heat up. This is normal and should not affect the device's lifespan or performance. If the battery gets hotter than usual, the charger may stop charging.
- If the device is not charging properly, take the device and the charger to a Samsung Service Centre.

After fully charging, disconnect the device from the charging cradle.

First remove the device from the charging cradle, unplug the charger from the charging cradle, and then unplug the charger from the electric socket.



To save energy, unplug the charger when not in use. The charger does not have a power switch, so you must unplug the charger from the electric socket when not in use to avoid wasting power. The charger should remain close to the electric socket and easily accessible while charging.

Checking the battery charge status

When you charge the battery while the device is off, the following icons will show the current battery charge status:



Wearing the device

1 Release the buckle.

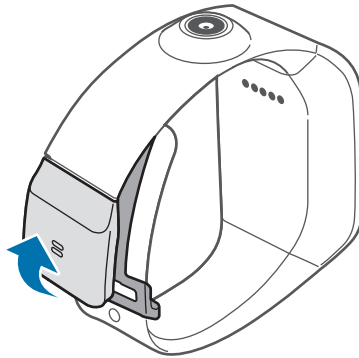

- Be careful not to damage your fingernails when you release the buckle.
- Do not bend the strap excessively. Doing so may damage the device.

2 Open the clasp and fit the strap to your wrist with the pin.

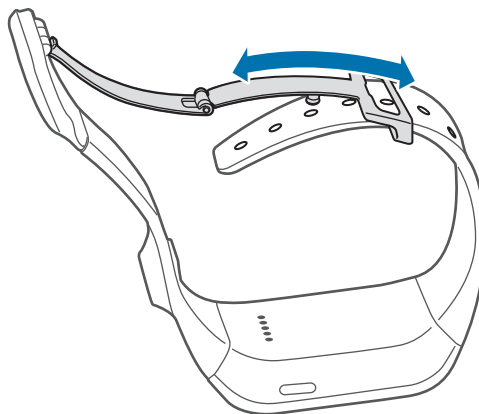

3 Press the buckle until it clicks.

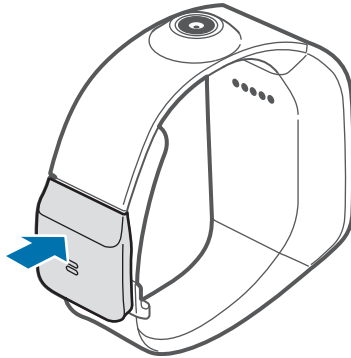

Turning the device on and off

When turning on the device for the first time, follow the on-screen instructions to connect the device to a smartphone or tablet PC and set up your device.

Press and hold the Power button for a few seconds to turn on the device.

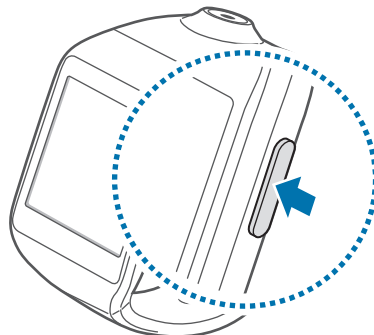

Follow all posted warnings and directions from authorised personnel in areas where the use of wireless devices is restricted, such as aeroplanes and hospitals.

To turn off the device, press and hold the Power button, and then tap **Power off**.

Connecting to a mobile device

By connecting the device to another mobile device, you can use applications and features on the connected mobile device.

To connect the device to another mobile device, use the charging cradle that has a built-in NFC antenna and an embedded Bluetooth address that matches your device.

First, activate the NFC feature on the mobile device. When turning on the device for the first time or after resetting the device, touch the back of the charging cradle to the back of the mobile device. Then, follow the on-screen instructions.

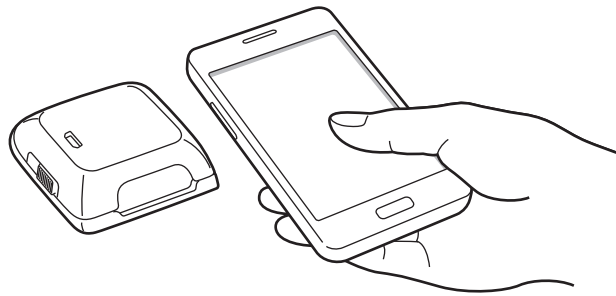

Gear Manager is installed on the mobile device and the devices are connected via the Bluetooth feature.



If you connect the devices with an optional charging cradle, launch **Gear Manager** on the mobile device, and then tap **Connect manually** to find and connect the devices.

Connecting manually

If your mobile device does not have an NFC feature you must connect the devices manually.

First, access **Samsung Apps** on the mobile device, and then download and install Gear Manager. When turning on the device for the first time or after resetting the device, launch Gear Manager on the mobile device. Then, follow the on-screen instructions.

Using applications after connecting to a mobile device

When the device is connected to a mobile device using the Bluetooth feature, you can use the following features and applications:

- **Calling:** Make a call or answer a call.
- **Viewing notifications:** Receive real-time notifications of a variety of events, such as missed calls or new messages.
- **Archive:** View messages.
- **Contacts:** View contacts.
- **Dialler:** Enter a number using the keypad and make a call.
- **Find my device:** Find the connected mobile device.
- **Logs:** View call and message logs.
- **Media Controller:** Play and control media files.
- **S Voice:** Command the device by voice.
- **Today's Schedule:** View today's events.
- **Weather:** View weather information.



Locking and unlocking the device

When not in use, lock the device to prevent unwanted operation. Pressing the Power button on the Clock screen turns off the screen and puts the device into lock mode. The device automatically gets locked if it is not used for a specified period.

Press the Power button to unlock the device.



Adjusting the brightness of the display

Use one of the following methods:

- Drag upwards or downwards on the screen with two fingers, and then tap  or  under **Brightness**.
- On the Home screen, scroll to **Apps**, tap **Apps** → **Settings** → **Display** → **Brightness**, and then adjust the brightness.

Adjusting the volume

Use one of the following methods:



- Drag upwards or downwards on the screen with two fingers, and then tap  or  under **Volume**.
- On the Home screen, scroll to **Apps**, tap **Apps** → **Settings** → **Volume**, and then select a category to adjust the ringtone volume or sound volume.



Do not hold the device's speaker close to your ears. Excessive exposure to loud sounds can cause hearing damage.

Switching to silent mode



Use one of the following methods:

- Press and hold the Power button, and then tap  or .
- On the Home screen, scroll to **Apps**, tap **Apps** → **Settings** → **Sound** → **Sound mode** → **Vibrate** or **Mute**.

Basics

Indicator icons

The following icons provide information about the status of the device. These icons appear when you double-tap the screen with two fingers.

Icon	Meaning
	Bluetooth feature activated
	Another Bluetooth device connected
	Battery power level

Using the touch screen

Use only fingers to use the touch screen.



- Do not allow the touch screen to come into contact with other electrical devices. Electrostatic discharges can cause the touch screen to malfunction.
- To avoid damaging the touch screen, do not tap it with anything sharp or apply excessive pressure to it with your fingertips.



- The device may not recognise touch inputs close to the edges of the screen, which are outside of the touch input area.
- Leaving the touch screen idle for extended periods may result in afterimages (screen burn-in) or ghosting. Turn off the touch screen when you do not use the device.

Finger gestures

Tapping

To open an application, to select a menu item, or to press an on-screen button, tap it with a finger.

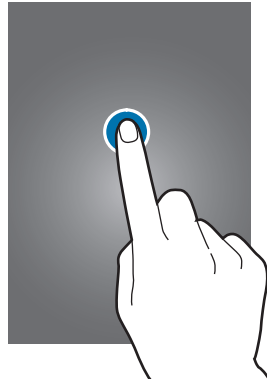

Tapping and holding

Tap and hold the screen with two fingers to open the list of recent applications.

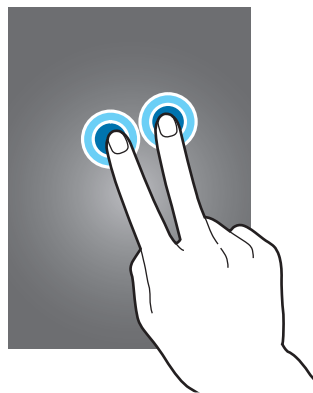

Dragging

Drag upwards or downwards on the screen with two fingers to access the brightness and volume control panel.

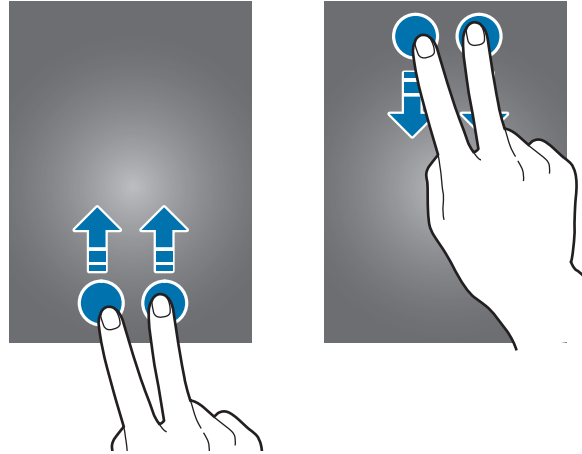

Double-tapping

- Double-tap on an image to zoom in a part. Double-tap again to return.

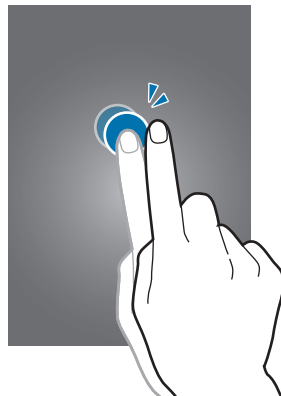

- Double-tap the screen with two fingers to view indicator icons, time, and date.

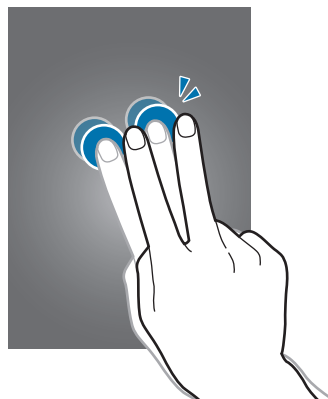

Flicking

Flick left or right on the Home screen or the Applications screen to see another panel.

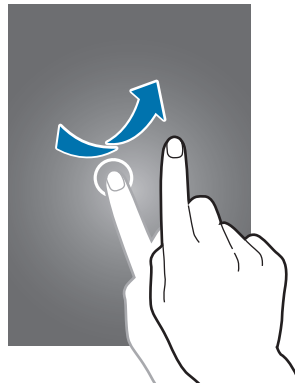

Pinching

Spread two fingers apart on an image to zoom in a part. Pinch to zoom out.

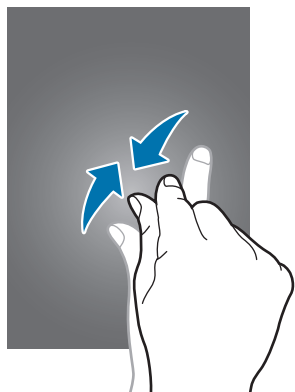

Notifications

Once the device is connected to a mobile device and the mobile device is locked, you can receive notifications of activities, such as missed calls or new messages.

When you receive notifications, tap the screen to view the details.

To view missed notifications, on the Home screen, scroll to **Notifications**, and then tap **Notifications**.

To view the notification history, on the Home screen, scroll to **Apps**, and then tap **Apps** → **Archive** or **Logs**.

Home screen

The Home screen is the starting point to access all of the device's features. It displays the clock, widgets, shortcuts to applications, and others.

The Home screen can have multiple panels. To view other panels, scroll left or right.

Panels on the Home screen

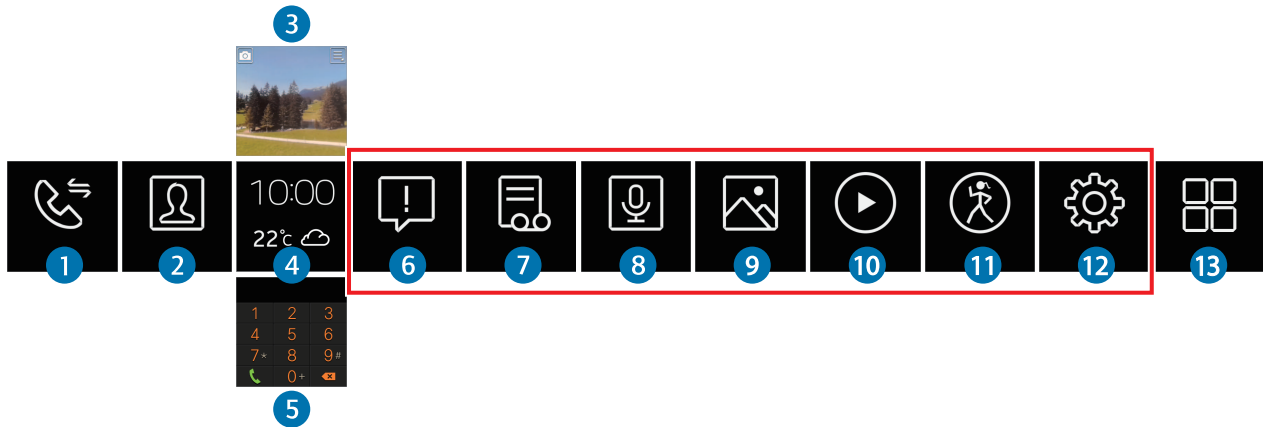

Number	Application or feature
1	Logs
2	Contacts
3	Camera
4	Clock
5	Dialler
6	Notifications
7	Voice Memo
8	S Voice
9	Gallery
10	Media Controller
11	Pedometer
12	Settings
13	Apps

You can customise the panels in the red box above. (p. 26)

Clock screen

Press the Power button to open the Clock screen.



On the Clock screen, you can launch **Dialler** by flicking up and launch **Camera** by flicking down. Tap the weather information to launch **Weather**.

Applications screen

The Applications screen displays icons for all applications.

On the Home screen, scroll to **Apps**, and then tap **Apps** to open the Applications screen.

To view other panels, scroll left or right.

Using applications

This device can run many different types of applications.

On the Home screen or the Applications screen, select a shortcut or an application icon to open it.

Returning to the previous screen

While using applications or on the Applications screen, flick down from the top of the screen.

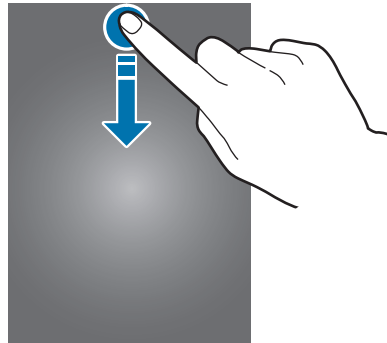

Securing the device

Prevent others from using or accessing personal data and information stored in the device by using the pattern lock.

Setting a pattern

On the Applications screen, tap **Settings** → **Privacy lock** → **Privacy lock** → **Pattern**.

Draw a pattern by connecting four dots or more, and then draw the pattern again to verify it.

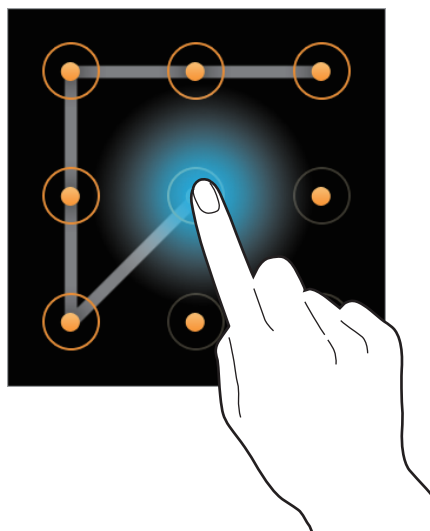

If you set a pattern lock, when the device disconnects from another mobile device, the pattern lock activates automatically.

Unlocking the device

Turn on the screen by pressing the Power button, and enter the unlock code.

Or, connect to the mobile device again to unlock the device automatically.



If the unlock code is forgotten, take the device to a Samsung Service Centre to reset it.

Bluetooth

Bluetooth creates a direct wireless connection between two devices over short distances.



- Samsung is not responsible for the loss, interception, or misuse of data sent or received via the Bluetooth feature.
- Always ensure that you share and receive data with devices that are trusted and properly secured. If there are obstacles between the devices, the operating distance may be reduced.
- Some devices, especially those that are not tested or approved by the Bluetooth SIG, may be incompatible with your device.
- Do not use the Bluetooth feature for illegal purposes (for example, pirating copies of files or illegally tapping communications for commercial purposes).
Samsung is not responsible for the repercussion of illegal use of the Bluetooth feature.

To activate Bluetooth, on the Applications screen, tap **Settings** → **Bluetooth**, and then tick **Bluetooth**.

Pairing with other Bluetooth devices

When the other Bluetooth device sends a request to pair with, accept the auto-generated passkey on the device to confirm.

Using calling features



While charging, you cannot answer calls.

Making a call

On the Applications screen, tap **Dialler**, enter a number with the keypad, and then tap . Or, tap **Logs** or **Contacts**, select a contact, and then tap if necessary.

During a call

The following actions are available:

- Adjust the volume by dragging upwards or downwards on the screen with two fingers, and then tapping or under **Volume**.
- / : Switch the volume between the lowest level and the level you set. If you set the volume to the highest level, will appear in red ().
- → : Turn off the microphone so that the other party cannot hear you.
- → : Disconnect your device and continue the call only on the mobile device.
- → : Open the keypad.
- → : Switch to a Bluetooth headset if it is connected to the mobile device.
- : End the current call.

Answering a call

When a call comes in, drag to the right.

If the call waiting service is active, another call can be made. When the second call is answered, the first call is put on hold.

Rejecting a call

When a call comes in, drag to the left.

Gear Manager

About Gear Manager

This application allows you to connect to a mobile device, customise your device settings and applications, and use features of the connected mobile device.

From the connected mobile device, tap **Gear Manager** on the Applications screen.

Configuring the device settings

Access device information and update device software.

Tap the device name, and then use the following features:

- **Rename:** Set a name for the device.
- **Disconnect:** End the connection between the device and the mobile device.
- **Connect new Gear:** Connect the mobile device to another watch.
- **Software update:** Update the device to the latest software.

Customising the Home screen

Customise the settings to change the clock type, add frequently-used applications to the Home screen, or reorganise applications on the Home screen.

Changing the clock type

Tap **Clocks**, and then select a clock under **All**.

To select what information to show on the Clock screen, tap  next to the clock under **Idle**.

Customising shortcuts

Adding shortcuts

Tap **My Apps** → **Favourites**. Tap , select applications, and then tap **Done**.



You can add up to 10 shortcuts.

Rearranging shortcuts

Tap **My Apps** → **Favourites**. Tap , tap and hold  next to the application name, drag it up or down to another position, and then tap **Done**.

Deleting shortcuts

Tap **My Apps** → **Favourites**. Tap , select applications, and then tap **Done**.

Managing applications

Viewing all applications

Tap **My Apps** → **Installed apps**. Scroll up or down to view all applications on the device.

Configuring applications settings

Tap **My Apps** → **Installed apps**. Tap  next to an application and configure settings.

Installing applications

Tap **Samsung Apps**. Browse applications and select an application to download. Applications are downloaded to both your device and the connected mobile device.

To browse and download suggested applications, tap **My Apps** → **Featured**.

Uninstalling applications

Tap **My Apps** → **Installed apps**. Tap , and then tap  next to an application.



Default applications that come with the device cannot be uninstalled.

Finding the device

If you misplace the device, Gear Manager will help you find the device by making it emit sounds and turn on the screen.

Tap **Find my Gear** → **Start**.

Activating the auto lock feature

Use this feature to set the mobile device to lock automatically when it is disconnected from your device.

Tap **Settings**, and then drag the **Auto lock** switch to the right.

Tap **Continue**, draw a pattern by connecting four dots or more, and then draw the pattern again to verify it.

When your device is not detected, the pattern lock activates automatically on the mobile device. When your device is detected again, the pattern lock is deactivated.

Activating the notification features

Stay up-to-date with a variety of events, such as missed calls or new messages, of the connected mobile device.

Tap **Settings** → **Notifications**, and then drag the **Notifications** switch to the right.

To activate notifications for each feature, select features by ticking.

Setting an application shortcut

You can launch an application quickly by pressing the Power button twice. First, set a shortcut to a frequently-used application.

Tap **Settings** → **Double pressing power key**, and then select an application.

Setting up emergency messages

Set the device to send an emergency message that includes a photo and your current location when you press the Power button 3 times.

Tap **Settings** → **Safety assistance**, and then drag the **Safety assistance** switch to the right. Read the terms and conditions, and then tap **OK** to agree to them. Then, tap **OK** → **Add contact** → an option, and then add the recipients for the message.

To edit the message that will be sent, tap **Edit emergency message**.

To set an interval for resending the message, tap **Message interval**.

To edit the recipients for the message, tap **Emergency contacts**.

Smart relay

Use this feature to view new messages, events, and other information on the mobile device when you receive notifications.



Before using this feature, make sure the motion feature of the mobile device is activated.

Tap **Settings** → **Smart relay**, and then drag the **Smart relay** switch to the right.

When you receive a notification, pick up the connected mobile device with the hand wearing the device. The mobile device shows the details. If the mobile device is locked, you must enter the unlock code first.

Using a wake-up gesture

Set the device to recognise your gesture to wake up the device when the screen is turned off.

Tap **Settings** → **Wake-up gesture**, and then drag the **Wake-up gesture** switch to the right.

To wake up the device, raise the hand wearing the device and look at the screen for a few seconds. The screen turns on and the Clock screen appears.

Viewing help information

Use this feature to access help information for the device.

Tap **Help**.

Applications

Camera

Use this application to take photos or videos.

Use **Gallery** to view photos and videos taken with the device's camera. (p. 32)

Tap **Camera** on the Applications screen.



- The camera automatically shuts off when unused.
- Make sure that the lens is clean. Otherwise, the device may not work properly in some modes that require high resolutions.
- While charging, you cannot use this application.

Camera etiquette

- Do not take photos or videos of other people without their permission.
- Do not take photos or videos where legally prohibited.
- Do not take photos or videos in places where you may violate other people's privacy.

Taking photos

Taking a photo

Tap the screen to take a photo.

Switch between still and video mode.

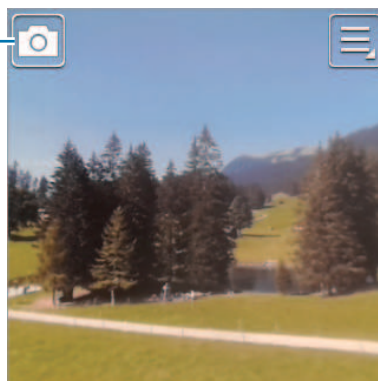

Change the camera settings.

Taking a photo with sound

Tap  → **Sound & shot** → **On**.

Tap the screen to take a photo. The device records a few seconds of audio after taking a photo. To stop recording, tap the screen again.

Taking videos

Taking a video

Tap , and then tap the screen to take a video. To stop recording, tap the screen again.

The maximum recording time is 10 seconds.

Configuring settings for Camera

Tap  to configure settings for Camera. Not all of the following options are available in both still camera and video camera modes.

- **Focus mode:** Select a focus mode. **Auto** is camera-controlled. **Macro** is for very close objects.



This setting will not be saved when you turn off this camera

- **Photo size / Video size:** Select a resolution. Use higher resolution for higher quality. But it takes up more memory.
- **Sound & shot:** Use this to take a photo with sound.



This setting will not be saved when you turn off this camera

- **Signature:** Set the device to add a signature to photos.

Gallery

Use this application to view images and videos.

Tap **Gallery** on the Applications screen.

Viewing images

Images are displayed by creation date.

Scroll left or right to view the next or previous image.

Zooming in and out

Use one of the following methods to zoom in an image:

- Double-tap anywhere to zoom in.
- Spread two fingers apart on any place to zoom in. Pinch to zoom out, or double-tap to return.

Playing videos

Video files show the  icon on the preview. Select a video to watch it and tap .

Deleting files

When viewing a file, tap  → **Delete**.

Sharing files

When viewing a file, tap  → **Share** to send it to others or share it via social network services.

Sending files to a mobile device

When viewing a file, tap  → **Transfer** to send it to the connected mobile device.

Archive

Use this application to view messages.

Tap **Archive** on the Applications screen.

Select a category → a message to view the details.

Tap  to use options, such as replying with **S Voice** or making a call.

Contacts

Use this application to view contacts on the connected mobile device.

Tap **Contacts** on the Applications screen.

You can make a call or send a message to a contact by scrolling left or right on a log entry.

Dialler

Use this application to open the dialling keypad and make a call.

Tap **Dialler** on the Applications screen.

Find my device

Use this application to find the connected mobile device.

Tap **Find my device** on the Applications screen.

Tap **Start**, the mobile device emits sounds, vibrates, and turns on the screen.



This application is available only when the devices are connected.

Logs

Use this application to view call logs on the mobile device.

Tap **Logs** on the Applications screen.

Media Controller

Use this application to play and control media files. You can launch the music player on the connected mobile device and control playback with the device. For videos, start playback on the mobile device first.

Tap **Media Controller** on the Applications screen.

Playing media files

Tap  to play music on the connected mobile device.

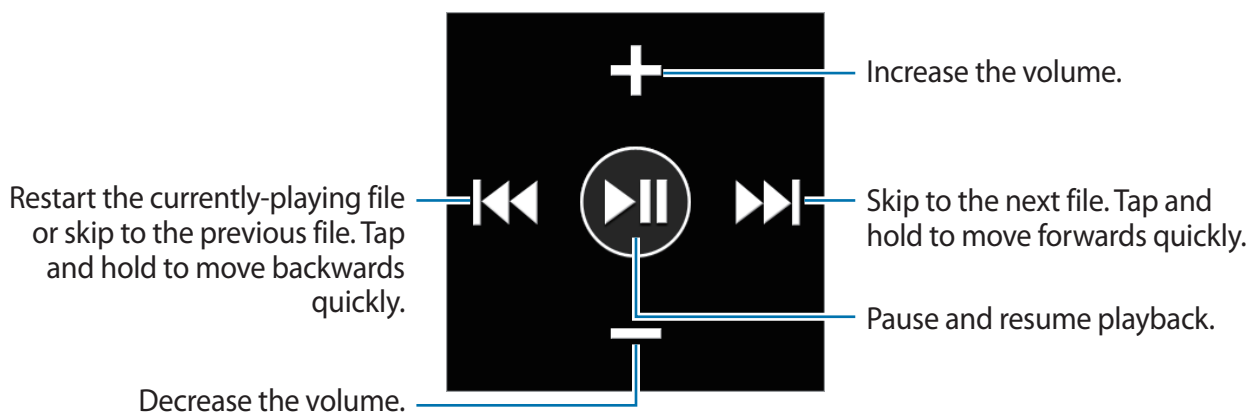

The controller screen may differ depending on the media type.

Pedometer

Use this application to track your steps and information about workouts for managing your health.

Tap **Pedometer** on the Applications screen.

Before You Start Exercising

This app can be used to monitor your exercise. While moderate physical activity, such as brisk walking, is safe for most people, health experts suggest that you talk with your doctor before you start an exercise program, particularly if you have any of the following conditions:

- Heart disease
- Asthma or lung disease
- Diabetes, or liver or kidney disease
- Arthritis

You should also check with your doctor if you have symptoms suggestive of heart, lung, or other serious disease, such as:

- Pain or discomfort in your chest, neck, jaw, or arms during physical activity
- Dizziness or loss of consciousness
- Shortness of breath with mild exertion or at rest, or when lying down or going to bed
- Ankle swelling, especially at night
- A heart murmur or a rapid or pronounced heartbeat
- Muscle pain when walking upstairs or up a hill that goes away when you rest

Finally, the American College of Sports Medicine recommends that you see your doctor before engaging in vigorous exercise if two or more of the following apply:

- You are a man older than age 45 or a woman older than age 55.
- You have a family history of heart disease before age 55.
- You smoke or quit smoking in the past six months.
- You have not exercise for three months or more.
- You are overweight or obese.
- You have high blood pressure or high cholesterol.
- You have impaired glucose tolerance, also call pre-diabetes.

When in Doubt - Check it Out

If you are unsure of your health status, have several health problems, or are pregnant, you should speak with your doctor before starting a new exercise program. Working with your doctor ahead of time is a good way to plan an exercise program that is right and safe for you. Consider it the first step on your path to physical fitness.

Setting a profile

Read and agree to the terms and conditions. Select a unit of measurement, and then enter your physical statistics.

Starting the pedometer

On the step count screen, start the pedometer to count your steps and view the walking distance and burned calories.

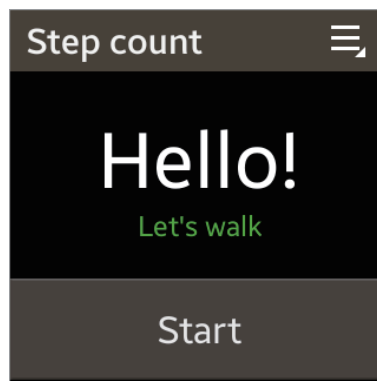

Tap **Start** to count your steps. To pause counting, tap the screen, and then tap **Pause**. To resume the pedometer, tap the screen, and then tap **Start**.

To change the step goal, tap  → **Goal**.



- You may experience a brief delay while the pedometer monitors your steps and then displays your step count.
- If you use the pedometer while travelling by car or train, vibration may affect your step count.

Checking the walking status

On the walking status screen, view the calorie burning status based on your walking pace.

On the step count screen, flick to the right to access the walking status screen while counting your steps.

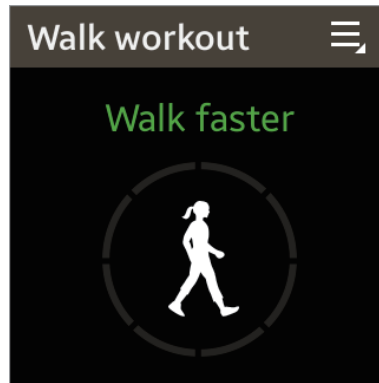

Exercising with training courses

On the S trainer screen, begin exercising by following the on-screen instructions.

On the step count screen, flick to the left to access the S trainer screen while counting your steps.

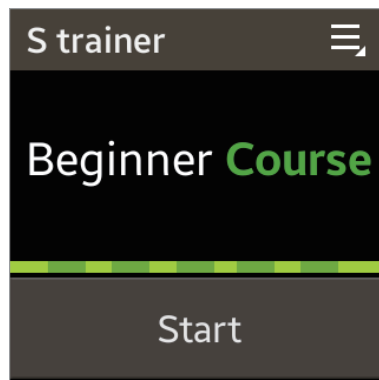

Tap **Start**, and then begin exercising. The device shows commands to help you control the intensity of your exercise. To stop exercising, tap the screen, and then tap **Stop**.

To change the training course, tap  → **Training course**, and then select a course.

S Voice

Use this application to command the device remotely by voice to dial a number, send a message, and more.

Tap **S Voice** on the Applications screen. Alternatively, press the Power button twice.



- This application may not be available depending on the region or service provider.
- This application is not supported in some languages.
- You can change the application to launch when you press the Power button twice. (p. 28)

Here are several examples of spoken commands:

- Open gallery
- Launch gallery
- Call Lulu mobile
- Check schedule

Tips for better voice recognition

- Speak clearly.
- Speak in quiet places.
- Do not use offensive or slang words.
- Avoid speaking in dialectal accents.

The device may not recognise your commands or may perform unwanted commands depending on your surroundings or how you speak.

Stopwatch

Use this application to measure the amount of elapsed time.

Tap **Stopwatch** on the Applications screen.

Tap **Start** to time an event. Tap **Lap** to record lap times.

Tap **Reset** to clear lap time records.

Timer

Use this application to use the device as a countdown timer.

Tap **Timer** on the Applications screen.

Set the duration, and then tap **Start**.

Tap **Dismiss** when the timer goes off.

Today's Schedule

Use this application to view today's events.

Tap **Today's Schedule** on the Applications screen.

Voice Memo



Use this application to record voice memos.

Tap **Voice Memo** on the Applications screen.



While charging, you cannot use this application.



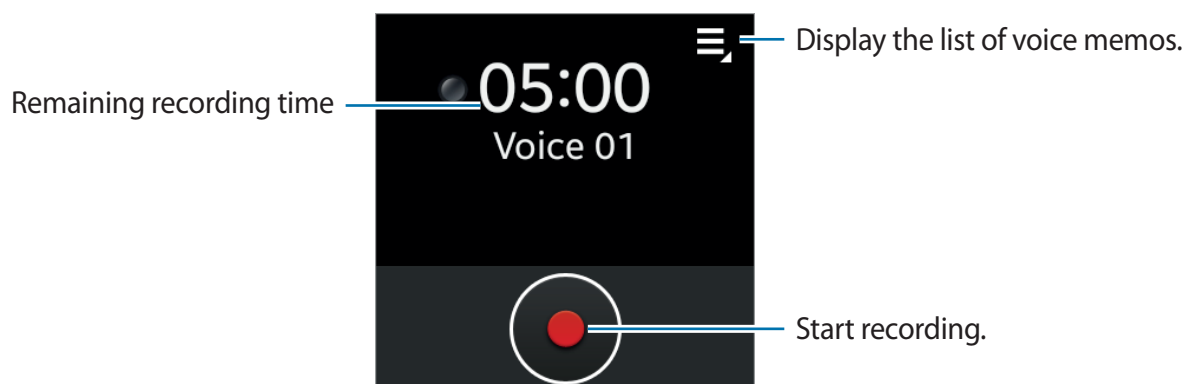

Recording voice memos

Tap  to start recording. Speak into the microphone at the top left of the device. Tap  to pause recording. Tap  to finish recording.



Playing voice memos

Select a voice memo to play. If spoken text is recorded and the text converting is finished,  appears next to the filename. The device shows the text on the screen during playback.

-  /  : Set the volume to low or high.
-  : Pause playback.
-  /  : Skip to the previous or next voice memo.

Weather

Use this application to view weather information for the locations that are set on the connected mobile device.

Tap **Weather** on the Applications screen.

When you add other locations on the mobile device, you can view weather information for them by scrolling left or right.

To view the weather information for this week, tap the screen.

Settings

About Settings

Use this application to configure the device and set application options.

Tap **Settings** on the Applications screen.

Clock

Access and alter the following settings to control how the device displays the time and date.



If the battery remains fully discharged, the time and date is reset.

- **Clock type:** Change the clock type.
- **Date and time:**
 - **Auto sync:** Automatically update the time and date when moving across time zones. To use this feature, the device must be connected to a mobile device.
 - **Set date:** Set the current date manually.
 - **Set time:** Set the current time manually.
- **Hourly alert:** Set the device to emit sounds or vibrate every hour.

Sound

Change settings for various sounds on the device.

- **Sound mode:** Activate silent mode to make your device vibrate or mute all sounds, except for media sounds.
- **Touch sounds:** Set the device to sound when selecting an application or option on the touch screen.
- **Ringtones:** Select a ringtone to alert you to incoming calls.
- **Notifications:** Select a ringtone for events, such as incoming messages and missed calls.
- **Vibration:** Select the force of the vibration notification.
- **Preferred arm:** Select the arm on which you wear the device. The main microphone will change depending on your selection.

Volume

Adjust the volume for various sounds on the device.

- **Multimedia:** Adjust the volume level for media sound.
- **Ringtones:** Adjust the volume level for call ringtones.
- **Notifications:** Adjust the volume level for notifications.
- **System:** Adjust the volume level for system sounds.

Display

Change the settings for the display.

- **Brightness:** Adjust the brightness for the display.
- **Screen timeout:** Set the length of time the device waits before turning off the display's backlight.
- **Home bg colour:** Set a colour for the Home screen.
- **Font size:** Change the font size.
- **Battery per...:** Set the device to display the remaining battery life when you double-tap the screen with two fingers.

Bluetooth

- **Bluetooth:** Turn the Bluetooth wireless feature on or off.
- **Visibility:** Set the device to be visible to other Bluetooth devices.

Privacy lock

- **Privacy lock:** Activate the screen lock feature.
- **Help:** Access help information about using the screen lock feature.

Language

Select a display language for all menus and applications. When your device is connected to a mobile device, the display language on the mobile device is applied to your device. You cannot change the language with your device.

Reset Gear

Reset settings to the factory default values and delete all data.

Gear info

Access device and battery information.

- **About Gear:** Access device information.
- **Battery:** View the remaining battery life.
- **USB debug:** Activate the USB debugging mode to connect your device to a computer with a USB cable.

Troubleshooting

Before contacting a Samsung Service Centre, please attempt the following solutions. Some situations may not apply to your device.

Your device does not turn on

When the battery is completely discharged, your device will not turn on. Charge the battery completely before turning on the device.

The touch screen responds slowly or improperly

- If you attach a protective cover or optional accessories to the touch screen, the touch screen may not function properly.
- If you are wearing gloves, if your hands are not clean while touching the touch screen, or if you tap the screen with sharp objects or your fingertips, the touch screen may malfunction.
- The touch screen may malfunction in humid conditions or when exposed to water.
- Restart your device to clear any temporary software bugs.
- Ensure that your device software is upgraded to the latest version.
- If the touch screen is scratched or damaged, visit a Samsung Service Centre.

Your device freezes or has fatal errors

If your device freezes or hangs, you may need to close applications and turn on the device to regain functionality. If your device is frozen and unresponsive, press and hold the Power button for more than 8-10 seconds to reboot.

If this does not solve the problem, perform a factory data reset. On the Applications screen, tap **Settings** → **Reset Gear** → **Reset**. Before performing the factory data reset, remember to make back-up copies of all important data stored on the device.

If the problem is still not resolved, contact a Samsung Service Centre.

Another Bluetooth device cannot locate your device

- Ensure that the Bluetooth wireless feature is activated on your device.
- Reset your device and try again.
- Ensure that your device and the other Bluetooth device are within the maximum Bluetooth range (10 m).

If the tips above do not solve the problem, contact a Samsung Service Centre.

A connection is not established when you connect the device to a mobile device

- Ensure that the Bluetooth feature on both devices is activated.
- Ensure that the mobile device's software is Android™ 4.1.2 or higher and the latest version of the Gear Manager application is installed.

Your device and the mobile device are disconnected

Restart both devices and launch the Gear Manager on the mobile device again.

Your device receives notifications at an interval different than the one you set on the mobile device

Ensure that you set the device's time and date to be updated automatically and the device is connected to the mobile device.

Calls are not connected

- Ensure that your device is connected to a mobile device.
- Ensure that the connected mobile device has accessed the right cellular network.
- Ensure that you have not set call barring for the phone number you are dialling on the connected mobile device.
- Ensure that you have not set call barring for the incoming phone number on the connected mobile device.

Others cannot hear you speaking on a call

- Ensure that you are not covering the built-in microphone.
- Ensure that the microphone is close to your mouth.

Sound echoes during a call

Adjust the volume or move to another area.

Audio quality is poor

You may have connectivity problems due to issues with the mobile device's network connections.

The battery icon is empty

Your battery is low. Recharge the battery.

The battery does not charge properly (For Samsung-approved chargers)

- Ensure that you place the device on the charging cradle and connect the cradle to the charger properly.
- If the charging terminals are dirty, the battery may not charge properly or the device may turn off. Wipe both gold-coloured contacts and try charging the battery again.
- The batteries in some devices are not user-replaceable. To have the battery replaced, visit a Samsung Service Centre.

The battery depletes faster than when first purchased

- When you expose the device to very cold or very hot temperatures, the useful charge may be reduced.
- Battery consumption increases when you use some applications.
- The battery is consumable and the useful charge will get shorter over time.

Your device is hot to the touch

When you use applications that require more power or use applications on your device for an extended period of time, your device may feel hot to the touch. This is normal and should not affect your device's lifespan or performance.

Error messages appear when launching the camera

Your device must have sufficient available memory and battery power to operate the camera application. If you receive error messages when launching the camera, try the following:

- Charge the battery.
- Free some memory by deleting files from your device.
- Restart the device. If you are still having trouble with the camera application after trying these tips, contact a Samsung Service Centre.

Photo quality is poorer than the preview

- The quality of your photos may vary, depending on the surroundings and the photography techniques you use.
- If you take photos in dark areas, at night, or indoors, image noise may occur or images may be out of focus.

A connection is not established when you connect the device to a computer

- Ensure that the USB cable you are using is compatible with your device.
- Ensure that you have the proper driver installed and updated on your computer.
- If you are a Windows XP user, ensure that you have Windows XP Service Pack 3 or higher installed on your computer.
- Ensure that you have Samsung Kies installed on your computer.

Data stored on the device has been lost

Always make backup copies of all important data stored on the device. Otherwise, you cannot restore data if it is corrupted or lost. Samsung is not responsible for the loss of data stored on the device.

A small gap appears around the outside of the device case

- This gap is a necessary manufacturing feature and some minor rocking or vibration of parts may occur.
- Over time, friction between parts may cause this gap to expand slightly.

Some content may differ from your device depending on the region, service provider, or software version, and is subject to change without prior notice.

