

Specifications sheet

Product name : Line Light Souce

Parts No. : L-CM012-MC6W1

Page NO.

page		drawing No.
1	Scope of Application, Part code	-
2	Outline drawing, Performance	-
3	Performance	-
4	Characteristics	-
5	Reliability	-
6	Packing Specifications	-
7	Precautions	-
8	Precautions	-

Applied Product Development Division			
Checked		Drawn	

SPECIFICATIONS

L-CM012-MC6W1

1/8

1. Scope of Application

These specifications are applied to the Lighting module, model L-CM series.

2. Part code

L - CM 012 - M C6 W1

Model name _____

L-CM012 : Lighting module
for general lighting

Special specifications _____

M : General Color Rendering Index Typ. 85 Type.

Watt Class _____

C6 : 6 watt module

Lighting color _____

W1 : Energy Star Correlated Color Temperature 4000(K)

△				
△				
△				
MARK	QTY	DATE	DESCRIPTION	ENGINEER

SPECIFICATIONS

L-CM012-MC6W1

2/8

3. Outline drawing

Unit : mm
Tolerance unless otherwise specified : ±0.3

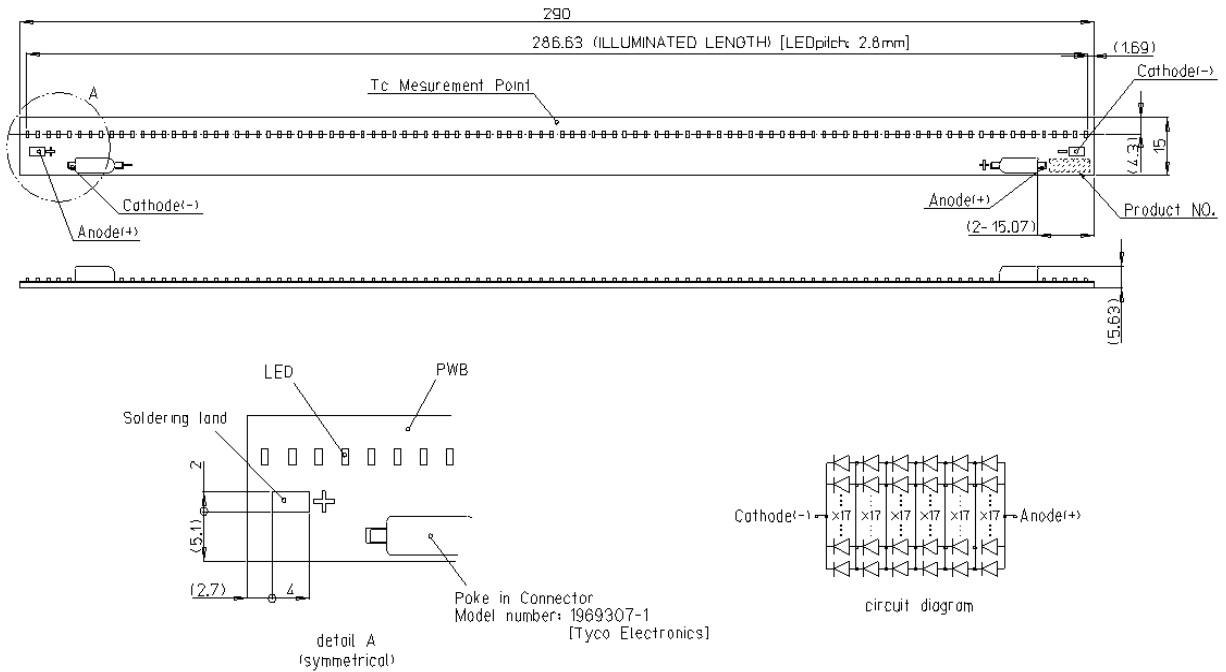

4. Performance

(1) Absolute Maximum Rating

Parameter	Symbol	Rating Value	Unit
Power Dissipation	P _d	9.1	W
Forward Current	I _F	425	mA
Operating Temperature	T _{OP}	-25 ~ +80	degC
Storage Temperature	T _{ST}	-30 ~ +90	degC
Junction Temperature *1	T _{J Max}	120	degC

*1 D.C. Current : $T_j = T_c + R_{j-c} \times P_d$

*T_c: Temperature of specific terminal

*2 This module is not designed to be driven in reverse bias.

△				
△				
△				
MARK	QTY	DATE	DESCRIPTION	ENGINEER

CITIZEN ELECTRONICS CO.,LTD.

Form No.GQP-0013-F09-1
(UQP-U013-F03-0)

Ref.CE-P662 03/10

SPECIFICATIONS

L-CM012-MC6W1

3/8

(2) Electro-optical Characteristics (Tc=25degC)

Parameter	Symbol	Condition	MIN	TYP	MAX	Unit
Forward Voltage	V_F	$I_F=350mA$	16.8	19.2	21.0	V
Thermal resistance	R_{j-c}	Junction-case	-	2.0	-	degC/W
Luminous Flux	Φ_v	$I_F=350mA$	350	490	-	lm
Color Temperature	CCT	$I_F=350mA$	-	4000	-	K
General Color Rendering Index	Ra	$I_F=350mA$	-	85	-	/

Chromaticity coordinates (Condition : $I_F=350mA$, $T_c=25degC$)

Color Rank	x	y
W1	0.401	0.404
	0.374	0.387
	0.367	0.358
	0.390	0.372

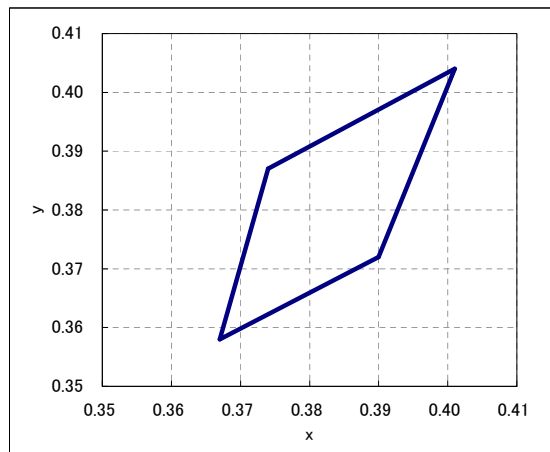

Note 1) The tolerance of measurement at our tester is $V_F \pm 3\%$, $\Phi_v \pm 10\%$, Chromaticity(x,y) ± 0.01 .

Note 2) For handling ,please apply CMOS LSI or equivalent any electrostatic effect.

△				
△				
△				
MARK	QTY	DATE	DESCRIPTION	ENGINEER

CITIZEN ELECTRONICS CO.,LTD.

Form No.GQP-0013-F09-1
(UQP-U013-F03-0)

Ref.CE-P662 03/10

SPECIFICATIONS

L-CM012-MC6W1

4/8

5. Characteristics

5-1 If- Φ_v characteristics (Tc=25degC)

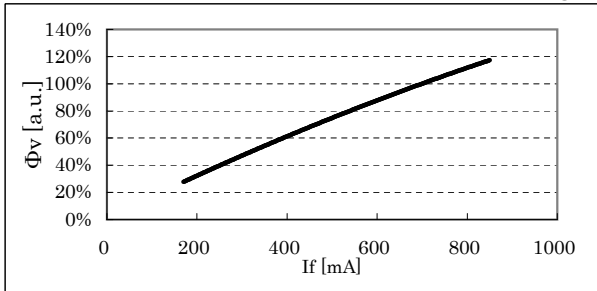

5-2 If-Vf characteristics (Tc=25degC)

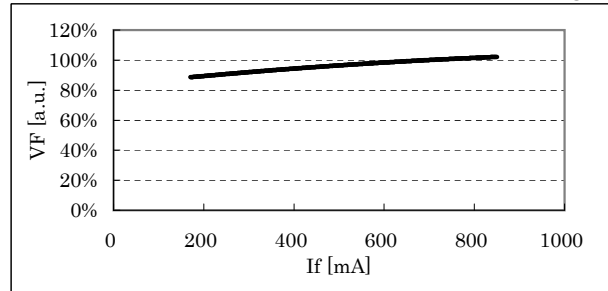

5-3 If- Δ_{xy} characteristics (If=350mA)

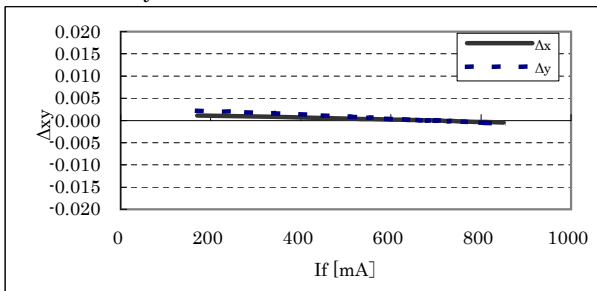

5-4 Tc- Δ_{xy} characteristics (Tc=25degC)

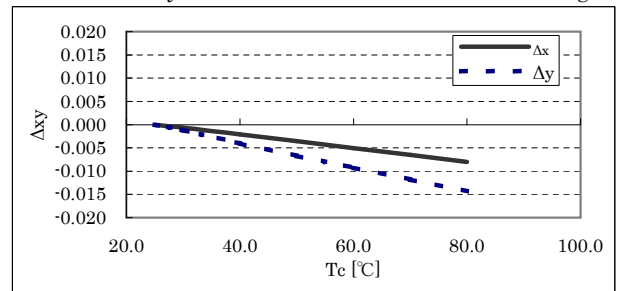

5-5 Tc-Vf characteristics (If=350mA)

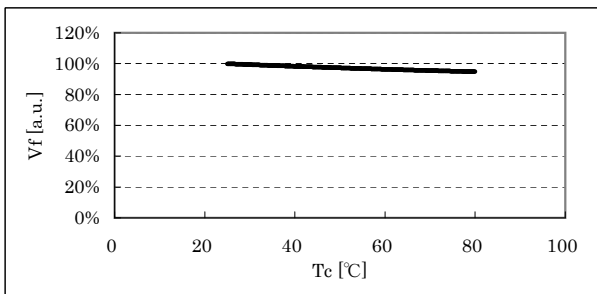

5-6 Tc- Φ_v characteristics (If=350mA)

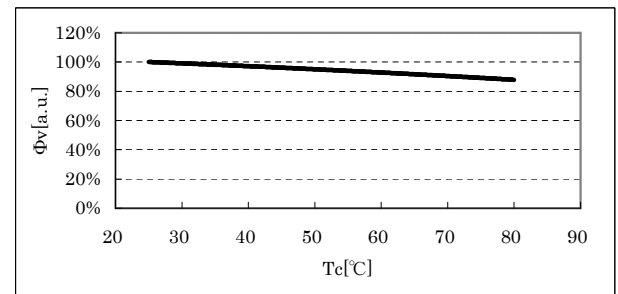

5-7 Tc-If characteristics

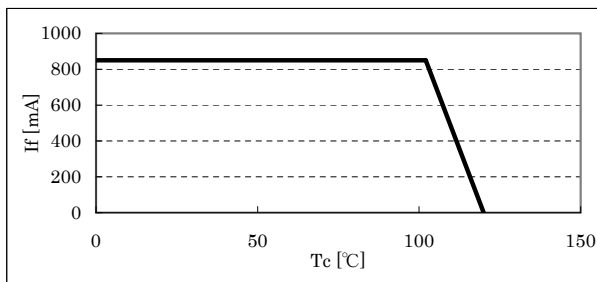

5-8 Spectrum

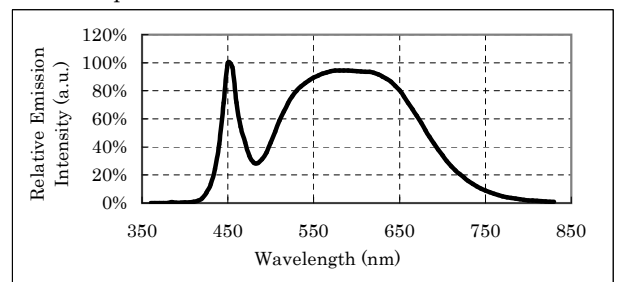

- Optical Characteristic were measured with an integrating sphere(40inch).

△				
△				
△				
MARK	QTY	DATE	DESCRIPTION	ENGINEER

CITIZEN ELECTRONICS CO.,LTD.

Form No.GQP-0013-F09-1
(UQP-U013-F03-0)

Ref.CE-P662 03/10

SPECIFICATIONS

L-CM012-MC6W1

5/8

6. Reliability

(1)Details of the tests

Test Item	Test Condition
Life Test in Continuous Operation	Ta=25degC, If=350mA , 1000hours
High Temperature Storage Test	90degC , 1000hours
Low Temperature Storage Test	-30degC , 1000hours
Moisture-proof Test	60degC, 90 ±5%RH , 1000hours
Thermal Shock Test	-30degC×30 minutes - 90degC×30 minutes, 100cycle

(2)Judgment Criteria of Failure for Reliability Test (Ta=25degC)

Measuring Item	Symbol	Measuring Condition	Judgement Criteria for Failure
Forward Voltage	V _F	I _F =350mA	>U×1.2
Luminous Flux	Φ _v	I _F =350mA	<S×0.7

U defines the upper limit of the specified characteristics. S defines the initial value.

Note: Measurement shall be taken between 2 hours and 24 hours, and the test pieces should be returned to the normal ambient conditions after the completion of each test.

△				
△				
△				
MARK	QTY	DATE	DESCRIPTION	ENGINEER

SPECIFICATIONS

L-CM012-MC6W1

6/8

7. Packing Specifications

(1) Packing

An empty tray is placed on top of a ten-tier tray which contain 10 pieces each.
The set of eleven trays is sealed in a plastic bag and then attached to a cardboard box.
(smallest packing unit: 100 pieces)

An indication label which specifies product name, quantity, lot number is attached to the outside of a plastic bag and a cardboard box.

Tray (Dimensions: 320 × 315 × 13.7 mm / Materials: Electrical conductive PS)

< Packing figure >

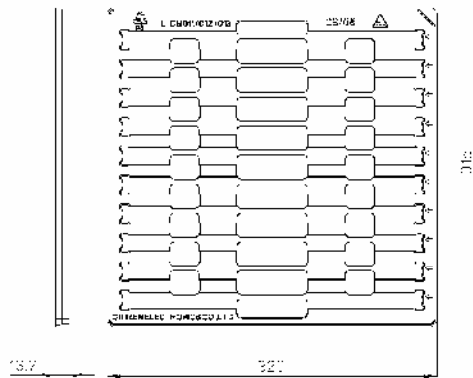

< Example of indication label >

<p>CUSTOMER: TYPE: L-CM012-MC6W1 P.NO: Lot No: XXXXXX Q'ty: XXX pcs</p> <div style="text-align: center;">  PASS </div> <p style="text-align: center;">CITIZEN ELECTRONICS</p>
--

△				
△				
△				
MARK	QTY	DATE	DESCRIPTION	ENGINEER

CITIZEN ELECTRONICS CO.,LTD.

Form No.GQP-0013-F09-1
(UQP-U013-F03-0)

Ref.CE-P662 03/10

SPECIFICATIONS

L-CM012-MC6W1

7/8

8. Precautions

(1) Operating and storage environment

- This product shall be used or stored under the environment where no condensation or corrosive factors such as chlorine gas, sulfur gas, acid, alkali, salt and others are present.
- In cases where this product is cleaned, bonded, and molded, these effects on product quality need to be checked using an intended equipment.
- This product shall be stored in the conditions that ambient temperature of 5~40degC and relative humidity of 20~70% and used within three months after being delivered.
- In cases where more than three months go by, the connectivity needs to be checked before usage.

(2) Handling

- For safety, LED light source should not be looked at directly.
- No manual or reflow soldering are available.
- No ultrasonic cleaning is available.
- Any detergents or chemicals should not be used since they could trigger the discoloration or degradation of this product and electrical shock.
- Please do not expose this product to excessive shock or vibration such as drop and others.
- Please avoid the application of any stress to the sealing resin area.
- Please avoid any contact by a sharp metal nail or other materials with the sealing resin area.
- This product shall not be bent or twisted forcibly.
Such handling could apply stress to soldering area and consequently induce no-lighting or shorten the product life significantly.
- When handling this product, some static measurements such as the wearing of a wristband or antistatic gloves are required to prevent any static electricity effect.
Any damages due to static should be checked by lighting inspection.

CE's lighting inspection criterion

Condition	Judgmental criterion
If=1mA or smaller per chip	No-lighting should not exist.

(3) Rating

- A constant current circuit is recommended as a drive circuit.
- When two or more LED modules are connected in parallel in the constant voltage circuit, the current-limiting resistance needs to be placed on each module so that they operate within the rating.
- Please design a circuit that prevents any reverse voltage (excess current) from being applied to this product instantaneously when the circuit is ON or OFF.
- This product shall be measured by a K thermocouple of ϕ 0.1mm with small thermal capacity under the conditions where this product is unaffected by radiant heat from other components or wind caused by convection. Excessive heat may deteriorate the LED's characteristics and reliability.

(4) Addition of fail safe function

- In cases where an LED or circuit shorts out for some reasons, this may result in electrical shock, fumes and ignition.
- To help eliminate these possibilities, please ensure that an appropriate fail-safe function such as a fuse is provided for your product.

△				
△				
△				
MARK	QTY	DATE	DESCRIPTION	ENGINEER

CITIZEN ELECTRONICS CO.,LTD.

Form No.GQP-0013-F09-1
(UQP-U013-F03-0)

Ref.CE-P662 03/10

SPECIFICATIONS

L-CM012-MC6W1

8/8

(5) Assembly

- Thermal conductive silicone grease should be applied to the whole rear surface so that this product can dissipate heat as a whole. However, the use of insulating paste is strongly recommended in order to avoid short circuit.
Insufficient heat dissipation may reduce the life of this product significantly.
- Please be careful not to apply any stress to the product during the clamping operation. As the connection status could vary depending on materials of outer heat sink, please check thoroughly.
- Please be aware that this product should not come into contact with any other parts in assembled.
- The aluminum-based PWB is used for this product. As the attachment to any materials that have greatly different thermal expansion coefficient from that of this product could trigger crack or drop because of thermal expansion or shrinkage, advance check is required.
- As for cleaning, please preliminarily confirm using an intended equipment if this product is free from any reliability concerns.
The residues left after cleaning may cause not only the reduction in surface resistance but also the corrosion of electrode parts and consequently lead to the deterioration of reliability.
- This product has connectors.
Use recommended wires suitable for the connectors at the time of assembly.
Use soldering lands on this product when needed.
 / Land size : 4 × 2 [mm]
 / Soldering operation should be performed within 3.5 seconds per land.
 The temperature of a soldering iron should be adjusted 350degC or lower.
 No external force is applied to sealing resin during soldering operation.
 Please do not handle a product until it returns to a normal temperature.
 Note: This product is not adaptable to reflow process.

(6) Others

- This product is intended for application in general electric devices (such as office automation equipment, communication devices, audio-video equipment, home electrical appliances, measurement hardware and others). In cases where this product is used for the following applications that require high reliability or could directly affect human life, health and property due to failure or malfunction, please consult our sales representatives beforehand.
 1. Aerospace hardware 2. Submarine equipment 3. Power plant control instrument
 4. Medical equipment 5. Transport machine (automobile, train, vessel)
 6. Traffic signal instrument 7. Security/disaster-prevention equipment
 8. Information processing devices 9. Other devices equivalent to 1 through 8
- Our warranty does not cover situations where this product undergoes secondary fabrication such as change in shape.
- This product complies with RoHS directives.
- The agreement of formal product specification is required prior to mass production.
- The specifications and appearance of this product are subject to change without advanced notice.

△				
△				
△				
MARK	QTY	DATE	DESCRIPTION	ENGINEER