

Dimensions mm[inch]
tolerances according to DIN ISO 2768-m
Toleranzen gem. DIN ISO 2768-m

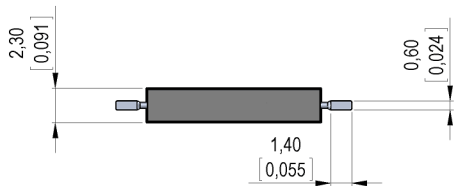

Isometric
Scale 2:1
Maßstab 2:1

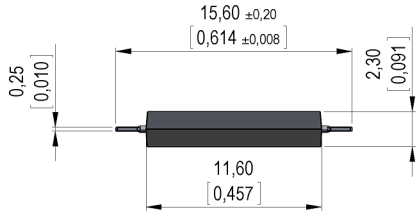

Marking

according to EN60062/factory code
gem. EN60062/Fertigungsstätte

MEDER F YM/P

Recommended PCB Pad Layout

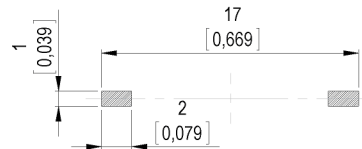

Solder Reflow Profile

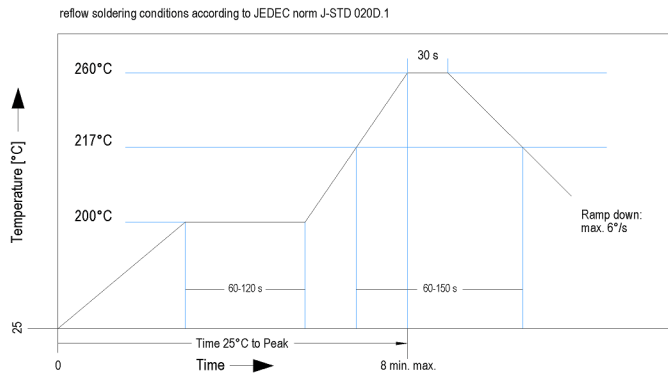

Packaging

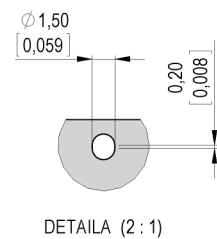
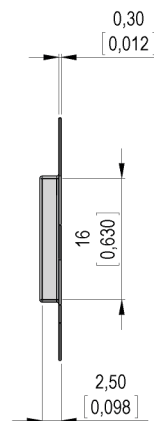
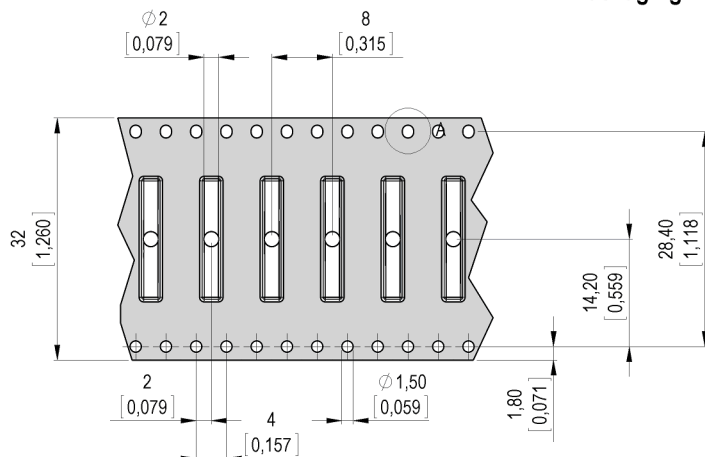



Products for tomorrow...

Europe: +49 / 7731 8399 0 | Email: info@meder.com
USA: +1 / 508 295 0771 | Email: salesusa@meder.com
Asia: +852 / 2955 1682 | Email: salesasia@meder.com

Item No.:
9161870016
Item:
MK16-F-1

Magnetic properties	Conditions	Min	Typ	Max	Unit
Pull-In excitation (modified contact)	Reed switch modified phys. conditioned tolerance +/- 1 AT	999		999	AT
Test equipment	Testing 100%	KMS-11			
Pull-In in milliTesla (modified contact)	MS150 - phys. caused tolerance +/- 0,1mT	999		999	mT

Contact data 87	Conditions	Min	Typ	Max	Unit
Contact rating	Any DC combination of V & A not to exceed their individual max.'s			10	W
Switching voltage	DC or Peak AC			200	V
Switching current	DC or Peak AC			0,4	A
Carry current	DC or Peak AC			0,5	A
Contact resistance static	Measured with 40% overdrive Start Value			150	mOhm
Contact resistance dynamic	Maximum value 1,5 ms after excitation Start Value			200	mOhm
Insulation resistance	RH <45 %, 100V - to all points	1			GOhm
Breakdown voltage	according to EN 60255-5	230			VDC
Capacitance	@ 10 kHz across open switch		0,2		pF

Special Product Data	Conditions	Min	Typ	Max	Unit
Reach / RoHS conformity			yes		

Modified dimensions	Conditions	Min	Typ	Max	Unit
total length - SMD			15,6		mm

Environmental data	Conditions	Min	Typ	Max	Unit
Shock	1/2 sine, duration 11ms, in 3 axis			50	g
Vibration	from 10 - 2000 Hz			20	g
Operating temperature		-40		130	°C
Storage temperature		-55		130	°C
Soldering Temperature Tsold	Reflow acc.IPC/JEDEC J-STD-020D.1			260	°C

Modifications in the sense of technical progress are reserved

Designed at: 07.11.12 Designed by: THAUKE

Approval at: 27.11.12 Approval by: AWEBER

Last Change at: Last Change by:

Approval at: Approval by:

Version: 1