

Data sheet

Heavy duty wirewound potentiometers

Ordering code no.: 31 910



Series 10 W
Type 10 W

Basic design: high load, nominal width 35 mm, solder tag terminals

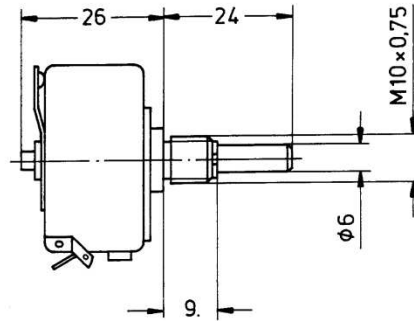
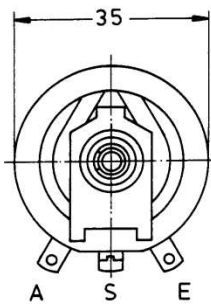

Technical data

Rated resistance range	4.7 Ω – 4.7 kΩ *	Isolation voltage	2000 V eff
Resistance tolerance	± 10 % (5 %, 2 %)	Electrical travel	250°
Law (resistance taper)	lin, lg on request	Mechanical travel	266°
Rated dissipation	10 W / 40 °C	Weight	approx. 50 g / piece

* higher values on request

Technical details subject to change

This catalogue gives no information on product availability. The information is only for product description and is not legally binding. Any technical item is subject to change.