

**Data sheet**

**Carbon composition film prest potentiometers**

**Ordering code no.: 00 011.....**

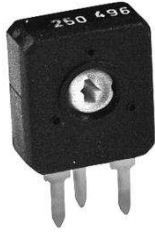

**Series 10**  
**Type VA 10**

Basic design: laminate base

**Special accessories:**

- Plastic moulded spindles on request

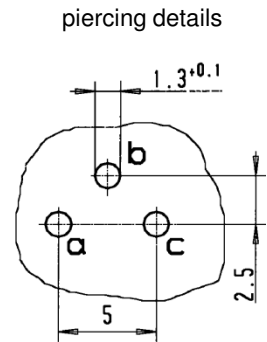
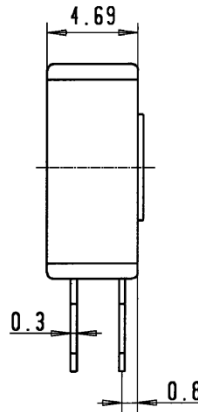
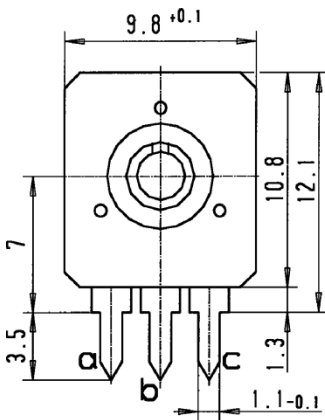

**Technical data**

Rated resistance range	100 Ω – 10 MΩ	Mechanical travel	295° ± 5°
Law (resistance taper)	lin	Operating torque	0.4 – 2 Ncm
Rated dissipation	0,15 W / 40 °C	End stop torque	≥ 5 Ncm
Limiting element voltage	200 V	Durability	200 cycles
Electrical travel	240 ± 20° *		

**Operating spindles**

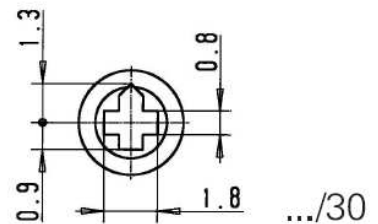
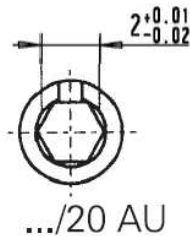
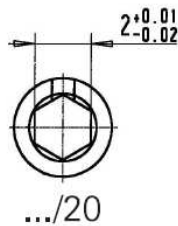
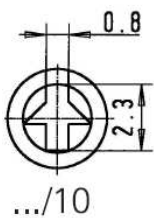

\* other values and laws on request

Technical details subject to change

This catalogue gives no information on product availability. The information is only for product description and is not legally binding. Any technical item is subject to change.