

JANUS REMOTE COMMUNICATIONS

PRODUCT BRIEF

Terminus CDMA Series CDMA864D Terminal Modem

Description

The Terminus CDMA864D is a communication control terminal with a compact enclosure that encapsulates everything needed for wireless M2M capability. Dual-band design allows for applications to be deployed on CDMA networks around the world.



The Terminus Series breaks through the barriers of M2M connectivity by minimizing investment and reducing total system costs. The Terminus contains all circuitry required to operate on the CDMA network. External antenna connection enables the system integrator to meet application specific antenna mounting requirements. The CDMA864D's allows for stand-alone use via industry standard interconnects or system integration via standard 50-pin 0.1" x 0.1" dual row header, further reducing the need for additional hardware costs. The CDMA864D ability to configure 7 GPIO as CMOS input or output makes the Terminus both innovative and cost effective. The ease of application development and GPS integration also opens the door for further system cost reduction.

Adaptable and easy to use, the CDMA864D is ideal for use in M2M Telemetry and Telematic applications including fleet and asset management, vending, security, alarm monitoring, e-maintenance and other telemetry applications.

Applications

- Fleet management
- Teleservice
- Security systems
- Telematics
- Telemetry and telecontrol
- Remote monitoring systems
- Remote meter reading
- Vending machines
- POS Terminals

Terminus Models & Ordering

Ordering	Description
CDMA864D v2.0	Sprint Certified
CDMA864D v3.0	Verizon Certified

2111 Comprehensive Drive
Aurora, Illinois 60505
630.499.2121
Fax: 630.851.5040
www.janus-rc.com

Bulletin **JA06-PB**
Revision **00**
Date **1 Sept 2011**



Making machines talk.

Features

CDMA Features

- Air interface IS-95A/B and CDMA 2000
- 1xRTT data up to 153.6 Kbps (full duplex)
- Full voice support includes supplementary services
- 2-way SMS support

Environmental

- Extended temperature range:
 - -30°C to +80°C (operational)
 - -40°C to +90°C (storage temperature)

Physical Interfaces

- Connectors
 - RS-232 9-pin Sub D
 - 4P4C handset jack
 - 50 Pin 0.1" dual in-line header general purpose interface
 - DC Power 2.1mm barrel jack
 - CDMA antenna jack (SMA)
 - GPS antenna jack (MCX)

Enclosure

- Rugged ABS plastic
- Size: 2.6" x 3.75" x 1.2" (66mm x 95.25mm x 30.84mm)
- Thru-case mountable with 2-#6 screws
- PC Board mountable

Performance

- Operating voltage: 7 to 26 VDC
- Average current consumption @ 12VDC (registered, no traffic): 28mA
- Sensitivity:
 - 1900 MHz: < -108 dBm
 - 800 MHz: < -108 dBm
- Maximum RF output power:
 - 24.3 dBm (270 mW)

Approvals - Certifications

- CE
- Verizon
- Sprint

Interfaces

- 7 Bi-directional CMOS I/Os
- UART select
- Power monitor
- 1 ADC
- Serial link through UART
 - Full RS-232 (CMOS levels at 50 pin header)
 - Baud rate 300 to 115.2 kbps
- Serial link through USB
 - Available through 50 pin header

GPS Features

- Stand alone GPS
- gpsOne® (user and control plane)
- NMEA data
- GPS fix on demand
- -151 dBm receiver sensitivity
- Dedicated GPS antenna connection for optimal GPS performance with active antenna support

Accessories (Optional)

- GPS antenna - see User Manual for installation guidelines
- CDMA antenna - see User Manual for installation guidelines
- AC power supply
- Evaluation kit (includes power supply, antennas and serial cable)

Additional Features

- Over-the-air provisioning and device management
- Over-the-air firmware update
- OMA-DM, OTASP, OTAPA (carrier dependent)
- Built in FTP client
- Built in SMTP (email) client
- Embedded TCP/IP stack with server and client functions
- Real time clock
- Alarm management

Support

- One year manufacturers warranty
- On-line technical documentation and FAQ
- FOTA services available via Telit

Mechanical Dimensions

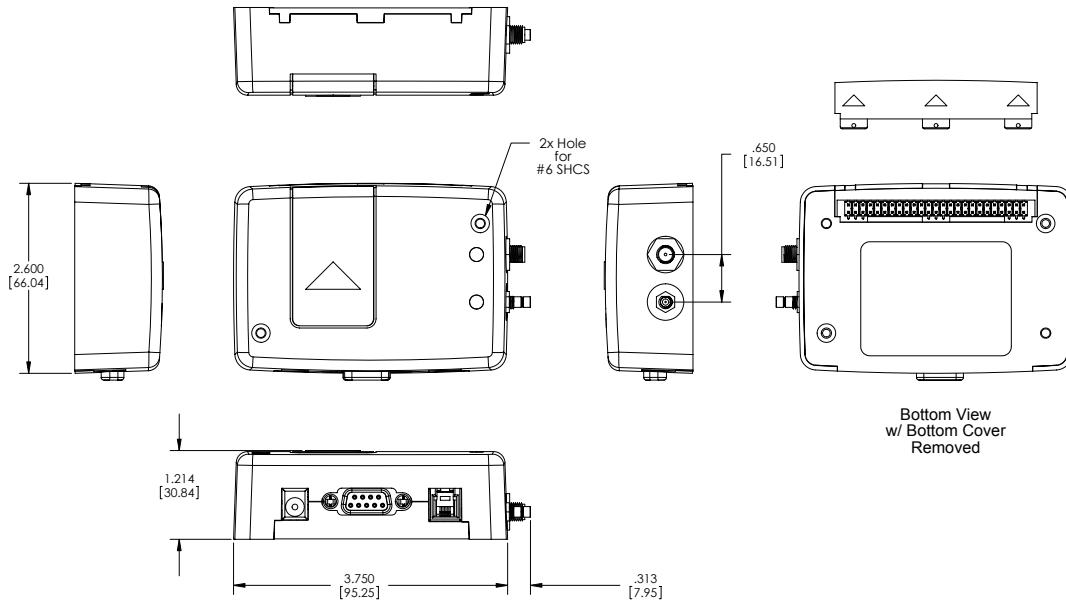

TOP DOWN VIEW

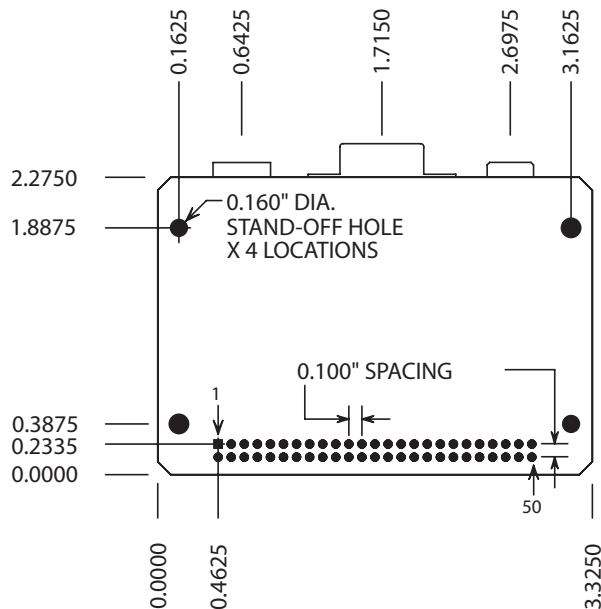

STAND-OFFS; KEYSTONE ELECTRONICS CORP #24436
 STAND-OFF SCREWS; KEYSTONE ELECTRONICS CORP #29311
 STAND-OFF HOLES ARE 0.160" DIA.

RECOMMENDED CONNECTORS:

(THROUGH-HOLE) SAMTEC SSQ-125-XX-X-D
 (SURFACE MOUNT) SAMTEC SSW-125-22-S-D-VS

ALL DIMENSIONS ARE IN INCHES

Terminus CDMA Series

CDMA864D Terminal Modem

Revision History

Revision	Revision Date	Note
P00	01/20/10	Preliminary Release
P01	03/16/11	Models & Ordering updates
P02	05/05/11	Verizon Certification Update
R00	09/01/11	Updated to Released Version

JANUS REMOTE
COMMUNICATIONS

Division of The Connor-Winfield Corporation
2111 Comprehensive Drive • Aurora, Illinois 60505
630.499.2121 • Fax: 630.851.5040

www.janus-rc.com

Janus Remote Communications Europe
Bay 143
Shannon Industrial Estate
Shannon, Co. Clare, Ireland
Phone: +353 61 475 666