

REV	ECN. NO.	APP	DATE
A	EDIÇÃO INICIAL		
B	NOVO CÓDIGO		

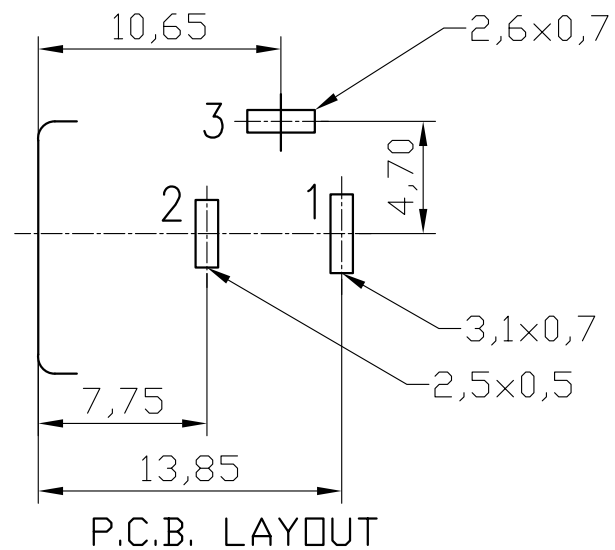

**HOW TO ORDER:
AJ200[25]D[]R
1 2**

- 1- Pin Diameter:
(2)-2,0mm
(25)-2,5mm
2-Function:
()-90°
(S)-180°

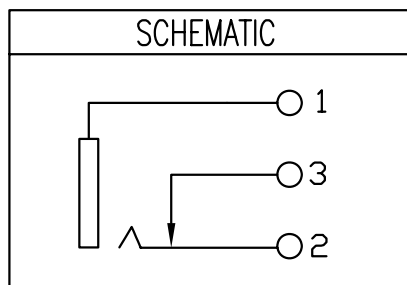
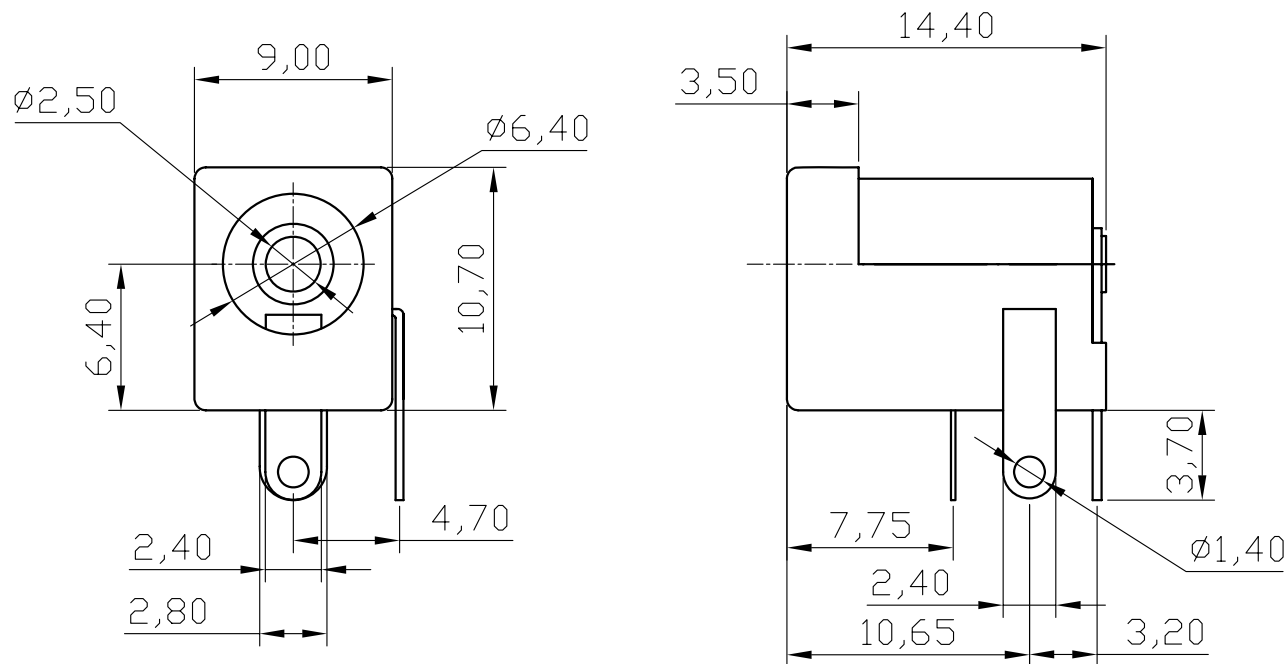

MATRIX TECNOLOGIA IND. E COM. LTDA.

UNIT mm	SCALE 3:1	TITLE DC POWER JACK 2,5mm	DATE MARCH 2010
TOLERANCE: ±0.25			APP. BY
		MATL	CHK. BY
		DWG. NO.	DR. BY FELIPE