



SCHOTTKY BARRIER SOLAR RECTIFIER

VOLTAGE 30 Volts CURRENT 12 Amperes

FEATURES

- * Low switching noise
- * Low forward voltage drop
- * Low thermal resistance
- * High current capability
- * High surge capability
- * High reliability
- * Ideal for solar panel PV application such as By-Pass diode

MECHANICAL DATA

- * Case: Slim PAQ
- * Epoxy: Device has UL flammability classification 94V-O
- * Lead: MIL-STD-202E method 208C guaranteed
- * Mounting position: Any

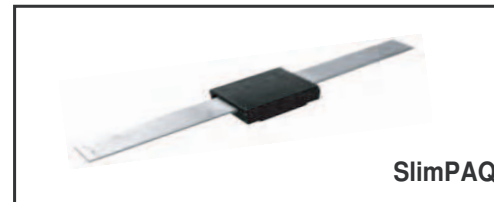

SlimPAQ

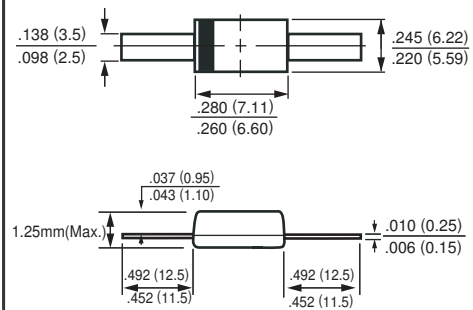

Dimensions in inches and (millimeters)

MAXIMUM RATINGS AND ELECTRICAL CHARACTERISTICS

Ratings at 25 °C ambient temperature unless otherwise specified.

MAXIMUM RATINGS (@ TA=25 °C unless otherwise noted)

RATINGS	SYMBOL	SPKC1230F	UNITS
Maximum Recurrent Peak Reverse Voltage	V _{RRM}	30	Volts
Maximum RMS Voltage	V _{RMS}	21	Volts
Maximum DC Blocking Voltage	V _{DC}	30	Volts
Maximum DC Forward Current @T _L =125°C(Note 1)	I _O	12	Amps
Peak Forward Surge Current 8.3 ms single half sine-wave superimposed on rated load (JEDEC method)	I _{FSM}	300	Amps
Typical Current Square Time	I ² T	373.3	A ² S
Typical Thermal Resistance	R _{θJC}	7.6	°C/W
	R _{θJA}	15.0	
	R _{θJL}	3.8	
Operating Temperature Range	T _J	175(T _J ≤200C in Bypass Mode)	°C
Storage Temperature Range	T _{STG}	-55 to + 175	°C

ELECTRICAL CHARACTERISTICS(@TA=25 °C unless otherwise noted)

CHARACTERISTICS	SYMBOL	SPKC1230F	UNITS
Maximum Instantaneous Forward Voltage at 12 A DC	@T _A = 25°C	.55	Volts
	@T _A = 75°C	.47	
Maximum Average Reverse Current at Rated DC Blocking Voltage	@T _A = 25°C	100	μA
	@T _A = 75°C	2.5	mA

- NOTES : 1. Heat-sink mounted 10mm max from body
 2. "Fully ROHS compliant", "100% Sn plating (Pb-free)".
 3. Available in Halogen-free epoxy by adding suffix -HF after the part nbr.

RATING AND CHARACTERISTICS CURVES (SPKC1230F)

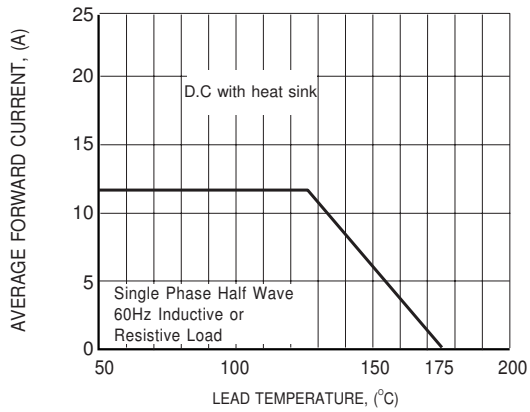

FIG.1 TYPICAL FORWARD CURRENT DERATING CURVE

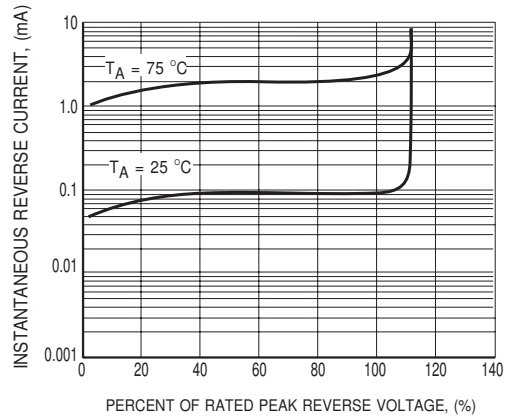

FIG.2 TYPICAL REVERSE CHARACTERISTICS

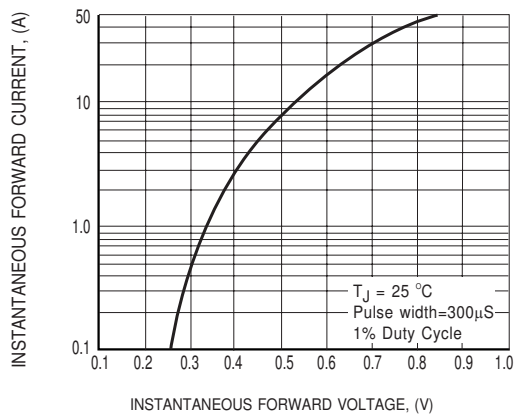

FIG.3 TYPICAL INSTANTANEOUS FORWARD CHARACTERISTICS

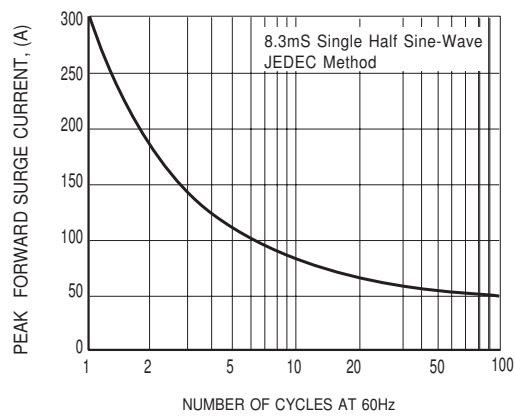
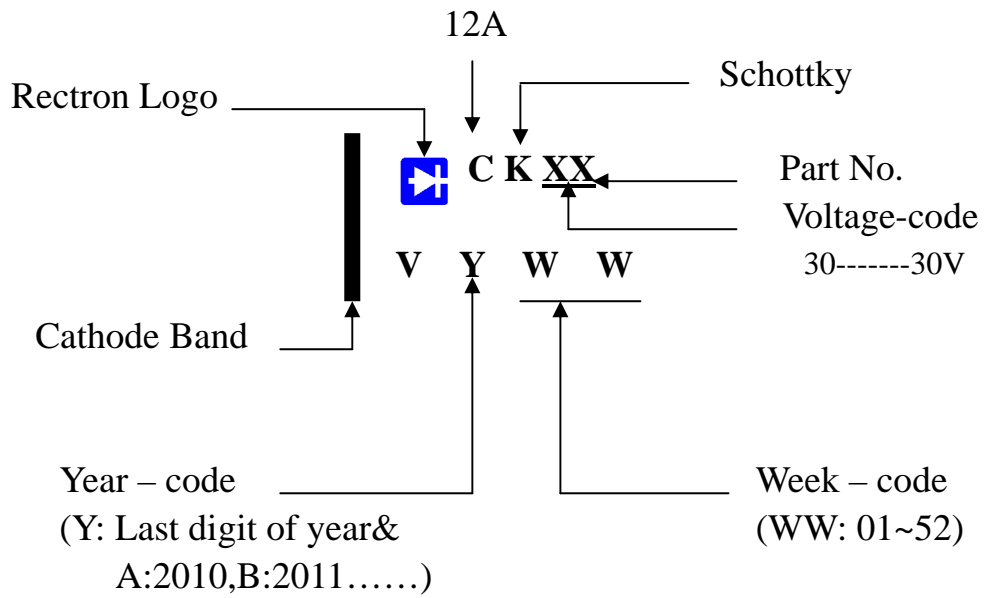

FIG.4 MAXIMUM NON-REPETITIVE FORWARD SURGE CURRENT

Marking Description



DISCLAIMER NOTICE

Rectron Inc reserves the right to make changes without notice to any product specification herein, to make corrections, modifications, enhancements or other changes. Rectron Inc or anyone on its behalf assumes no responsibility or liability for any errors or inaccuracies. Data sheet specifications and its information contained are intended to provide a product description only. "Typical" parameters which may be included on RECTRON data sheets and/ or specifications can and do vary in different applications and actual performance may vary over time. Rectron Inc does not assume any liability arising out of the application or use of any product or circuit.

Rectron products are not designed, intended or authorized for use in medical, life-saving implant or other applications intended for life-sustaining or other related applications where a failure or malfunction of component or circuitry may directly or indirectly cause injury or threaten a life without expressed written approval of Rectron Inc. Customers using or selling Rectron components for use in such applications do so at their own risk and shall agree to fully indemnify Rectron Inc and its subsidiaries harmless against all claims, damages and expenditures.

