

Z2PK106H

● **FEATURES**

- * Halogen-free type
- * Compliance to RoHS product
- * Lead less chip form, no lead damage
- * Low power loss, High efficiency
- * High current capability, low VF
- * Plastic package has Underwriters Laboratory Flammability Classification 94V-0
- * Patented ZPAK™ Package Technology

● **APPLICATION**

- * Switching mode power supply applications
- * Portable equipment battery applications
- * General rectification
- * DC / DC Converter
- * Telecommunication

● **MECHANICAL DATA**

Case : Packed with FRP substrate and epoxy underfilled
Terminals : Pure Tin plated (Lead-Free), solderable per MIL-STD-750, Method 2026.
Polarity : Laser Cathode band marking
Weight : 0.012 gram

● **PACKING**

- * 3,000 pieces per 7" (178mm ± 2mm) reel
- * 4 reels per box
- * 6 boxes per carton

● **OUTLINE DIMENSIONS**

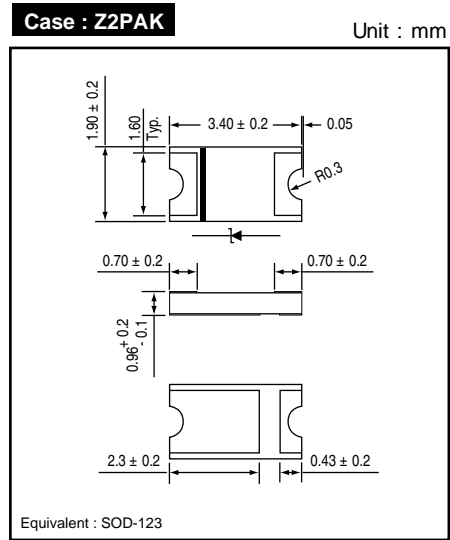

● **MARKING**

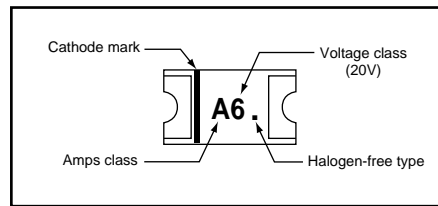

Absolute Maximum Ratings (Ta = 25 °C)

ITEM	Symbol	Conditions	Rating	Unit
			Z2PK106H	
Repetitive peak reverse voltage	VRRM		60	V
Average forward current	IF(AV)		1.0	A
Peak forward surge current	IFSM	8.3ms single half sine-wave	20	A
Operating junction temperature Range	Tj		-55 to +125	°C
Storage temperature Range	TSTG		-55 to +150	°C

Electrical characteristics (Ta = 25 °C)

ITEM	Symbol	Conditions	Min.	Typ.	Max.	Unit
Forward voltage (NOTE 1)	VF	IF = 0.1A	-	0.38	-	V
		IF = 0.5A	-	0.48	-	
		IF = 1.0A	-	0.60	0.70	
Repetitive peak reverse current (NOTE 1)	IRRM	VR = Max. VRRM , Ta = 25 °C	-	0.015	0.2	mA
Junction capacitance	Cj	VR = 4V, f = 1.0 MHz	-	110	-	pF
Thermal resistance	Rth(JA)	Junction to ambient (NOTE 2)	-	88	-	°C / W
	Rth(JL)	Junction to lead (NOTE 2)	-	28	-	°C / W

NOTES : (1) Pulse test width PW=300usec , 1% duty cycle.
 (2) Mounted on P.C. board with 0.2 x 0.2"(5.0 x5.0mm) copper pad areas.

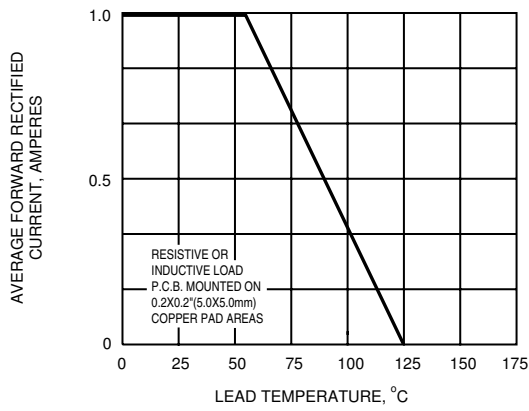
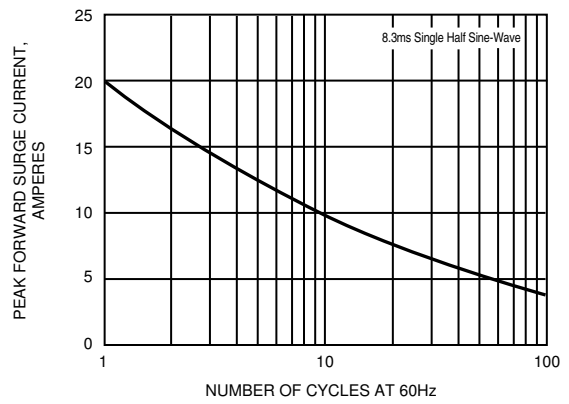
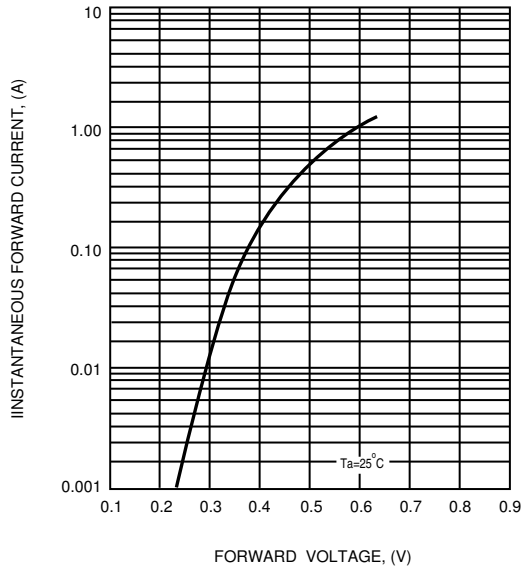
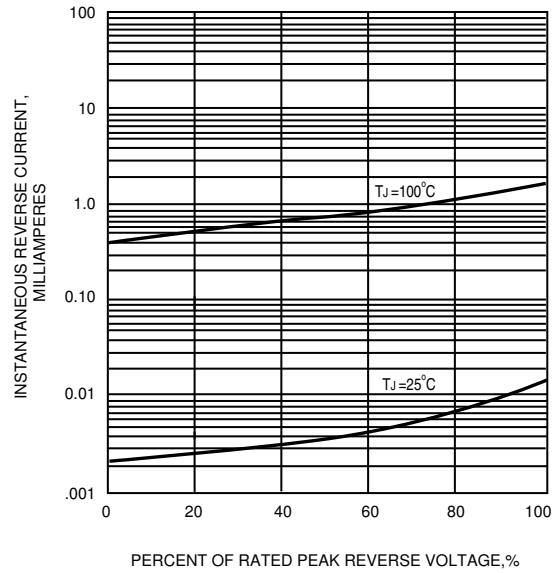
FIG.1 - FORWARD CURRENT DERATING CURVE

FIG.2 - MAXIMUM NON-REPETITIVE PEAK FORWARD SURGE CURRENT

FIG.3 - TYPICAL INSTANTANEOUS FORWARD CHARACTERISTICS

FIG.4 - TYPICAL REVERSE CHARACTERISTICS

FIG.5 - TYPICAL JUNCTION CAPACITANCE
