

## Output Voltage 1.8V-3.3V Ultra High Efficiency 92% O-3PL Size, Step-Down Non-Isolated Type DC-DC Converter **10 Watt VSI-mini A Series**

VSI-mini A Series is an ultra small, TO-3PL packaged type, and non-isolated type step-down DC-DC converter which has achieved ultra high efficiency by the latest synchronous rectification circuit technology. VSI-mini A Series with the size of 20.2×21.5×8.3mm and 10W can be used without heat sink and external capacitor.

### <Features>

- Synchronous Rectification Control IC equipped
- Solid Electrolytic Chip Capacitor equipped.
- Convertible with high efficiency 7.5V→3.3V
- High efficiency 92%
- Low standby input current 100μA max.
- Wide operating temperature range -10°C to 70°C
- MTBF 1,000,000 Hrs, All aging
- Output capacitor installed
- Heat Sink not required
- Low profile, Ultra small type
- Remote ON/OFF control
- Wide input voltage range
- Over-current protection
- Non-isolated type
- Adjustable output voltage
- High reliability, long life, high performance

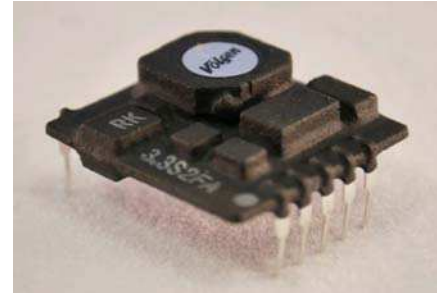

SIP&DIP: External resinous coating  
SMD : Without resinous coating

### <Model>

Table 1

Model	Rating Input Voltage Vdc	Input Voltage Range Vdc	Rating Output Voltage Vdc	Output Voltage Trim Range Vdc	Output Current A	Ripple/ Noise mVpp(typ)	Efficiency %(typ)	Package
VSI-mini A Series								
VSI-3.3S2R0MA	7.5	4.75-13.6	3.3	1.8-3.3	0-2	30	92	SIP
VSI-3.3S2R0FMA								DIP
VSI-5.0S2R0SMA								SMD

SMD type : Order received product

### <Specification>

Table 2

Rating input voltage/range	7.5V / 4.75-13.6V
Rating output voltage	3.3V±5% (When 1pin is open)
Adjustable output range	+1.8-3.3V
Line regulation	0.2% typ. (For the input voltage range of 4.75-13.6V, at rating load.)
Load regulation	0.6% typ. (At rating input voltage, when load changes 0%~100%)
Temperature coefficient	±0.01%/°c typ. (When operating temperature changes between -10°C-50°C)
Ripple & Noise	30mVp-p typ. (Rating input / output, room temperature) (20MHz bandwidth)
Efficiency	92% (Rating input / output, room temperature)
Over-Current Protection	Operates at more than 105% of rating load current, auto recovery type, foldback recovers. Avoid more than 30seconds of short-circuit condition
Over-Voltage Protection	None
No Load Input Current	3mA max. At no load and output on
Standby Input Current	100μA max. At no load and output off (0V)
Remote on/off control	Between 1pin(on/off pin) and 3pin(GND); Open=output ON, short=output off
MTBF	1,000,000Hr min(EIAJ RCR-9102)
Switching frequency	190kHz typ. (20%~100% load current range, When the load is 0%~20% the switching frequency will go down.)
Operating temperature range	-10°C-70°C (Derating to be required from 50°C)
Storage temperature range	-20°C-85°C
Humidity range	20%~95%R.H. (non condensing)
Cooling condition	Natural air cooling
Vibration	5~10Hz All amplitude 10mm (1 hour in each of 3 directional axes), 10~55Hz acceleration 2G (1 hour in each of 3 orthogonal axes)
Shock	Acceleration 20G (3 times in each of 3 directional axes), Shocking Time 11±5ms
Weight	3.8g typ.
Outline	Refer to page 2.

\* The above specification is provided with rating value, unless specified conditions is described.

<Outline>  
[ SIP type ]  
VSI-3.3S2R0MA

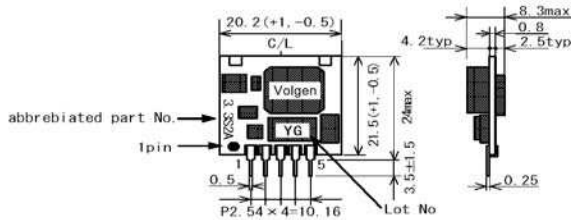

Figure 1

pin	Function
1	ON/OFF CONT
2	+Vin
3	GND
4	+Vout
5	+Vout.ADJ

Dimensions: mm  
Tolerance when nothing specified  $\pm 0.5$   
External resinous coating  
Pin substances: Phosphor bronze (Plating: Sn)  
Treatment: Soldering dip treatment with Sn-3.0Ag-0.5cu

[ DIP type ]  
VSI-5.0S2R0FMA

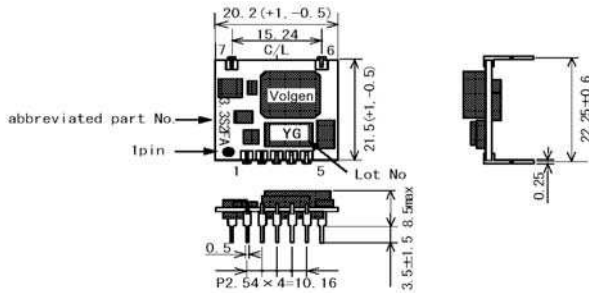

Figure 2

pin	Function
1	ON/OFF CONT
2	+Vin
3	GND
4	+Vout
5	+Vout.ADJ
6	NC
7	NC

Dimensions: mm  
Tolerance when nothing specified  $\pm 0.5$   
External resinous coating  
Pin substances: Phosphor bronze (Plating: Sn)  
Treatment: Soldering dip treatment with Sn-3.0Ag-0.5cu

[ SMD type ]  
VSI-5.0S2R0SMA  
( for order received product )

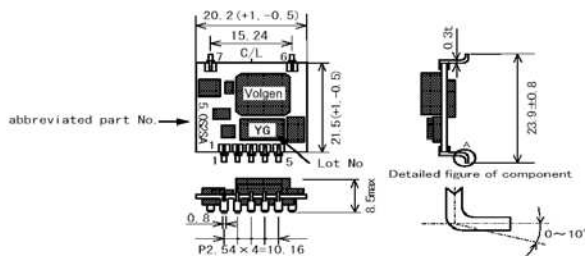
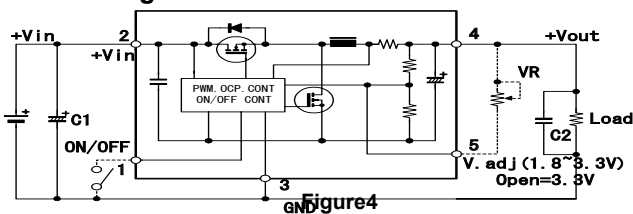

Figure 3

pin	Function
1	ON/OFF CONT
2	+Vin
3	GND
4	+Vout
5	+Vout.ADJ
6	NC
7	NC

Dimensions : mm  
Tolerance when nothing specified  $\pm 0.5$   
Without coating.  
( for adsorption mounter air )  
Pin substances: Phosphor bronze (Plating: Sn)  
Treatment: Soldering dip treatment with Sn-3.0Ag-0.5cu

<Block Diagram>



- Use this model according to a usual three terminal regulator.
- Output Voltage  
5pin Open= +5V (rating output voltage)
- C1 : More than 100 $\mu$ F (In order to reduce the line impedance)
- C2 : Output capacitor built-in.  
In case that the wiring is long to the load, output noise may be further reduced with the 2.2 $\mu$ F~4.7 $\mu$ F added.
- Refer to figure 6~8 about :  
adjustment output voltage, on/off control.
- Refer to page 6 about : over-current protection, soldering conditions, and cleaning conditions.

VSI-mini A Series is an ultra small, TO-3PL packaged type, and non-isolated type step-down DC-DC converter which has achieved ultra high efficiency by the latest synchronous rectification circuit technology. VSI-mini A Series with the size of 20.2×21.5×8.3mm and 10W can be used without heat sink and external capacitor.

### <Features>

- Synchronous Rectification Control IC equipped.
- Solid Electrolytic Chip Capacitor equipped.
- Convert +12V into +5V with high efficiency
- High efficiency 93%
- Low standby input current 100μA max
- Wide operating temperature range -10~+70°C
- MTBF 1,000,000 Hrs, All aging
- Output capacitor installed
- Heat Sink not required
- Ultra low profile, Ultra small type
- Remote on/off control
- Wide input voltage range
- Over current protection Circuit
- Non-Isolated type
- Adjustable output voltage
- High reliability, long life, high performance

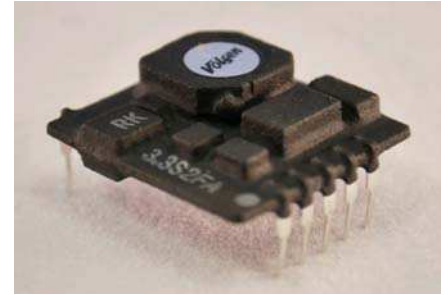

SIP&DIP: External resinous coating  
SMD : Without resinous coating

### <Model>

Table 1

Model	Rating Input Voltage Vdc	Input Voltage Range Vdc	Rating Output Voltage Vdc	Output Voltage Trim Range Vdc	Output Current A	Ripple & Noise mVpp(typ)	Efficiency %(typ)	Package
VSI-mini A Series								
VSI-5.0S2R0MA	12	+6.0~+16.5	+5.0	3.0~5.0	0~2	30	93	SIP
VSI-5.0S2R0FMA								DIP
VSI-5.0S2R0SMA								SMD

SMD type : Order received product

### <Specification>

Table 2

Rating input voltage/range	+12V / +6.0~+16.5V
Rating output voltage	5.0V±5% (When 1pin is open)
Adjustable output range	+3.0~+5.0V
Line regulation	0.2% typ. (For the input voltage range of +6~+16.5V, at rating load.)
Load regulation	0.4% typ. (At rating input voltage, when load changes 0%~100%)
Temperature coefficient	±0.01%/°c typ. (When operating temperature changes between -10°C~+50°C)
Ripple & Noise	30mVp-p typ. (Rating input / output, room temperature) (20MHz bandwidth)
Efficiency	93% (Rating input / output, room temperature)
Over-Current Protection	Operates at more than 105% of rating load current, auto recovery type, foldback recovers. Avoid more than 30seconds of short-circuit condition
Over-Voltage Protection	None
No Load Input Current	3mA max. At no load and output o
Standby Input Current	100μA max. At no load and output off (0V)
Remote on/off control	Between 1pin(on/off pin) and 3pin(GND); Open=output ON, short=output off
MTBF	1,000,000Hr min(EIAJ RCR-9102)
Switching frequency	190kHz typ. (20%~100% load current range, When the load is 0%~20% the switching frequency will go down.)
Operating temperature range	-10°C~+70°C (Derating to be required from +50°C)
Storage temperature range	-20°C~+85°C
Humidity range	20%~95%R.H. (non condensing)
Cooling condition	Natural air cooling
Vibration	5~10Hz All amplitude 10mm (1 hour in each of 3 directional axes), 10~55Hz acceleration 2G (1 hour in each of 3 directional axes)
Shock	Acceleration 20G (3 times in each of 3 directional axes), Shocking Time 11±5ms
Weight	3.8g typ.
Outline	Refer to page 2.

\* The above specification is provided with rating value, unless specified conditions is described.

<Outline>  
[ SIP type ]  
VSI-5.0S2R0MA

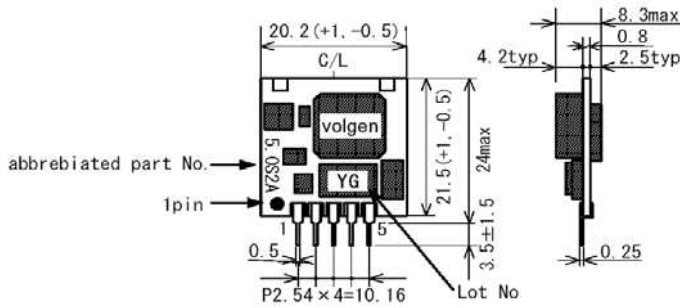

Figure1

pin	Function
1	ON/OFF CONT
2	+Vin
3	GND
4	+Vout
5	+Vout.ADJ

Dimensions: mm  
Tolerance when nothing specified  $\pm 0.5$   
External resinous coating

[ DIP type ]  
VSI-5.0S2R0FMA

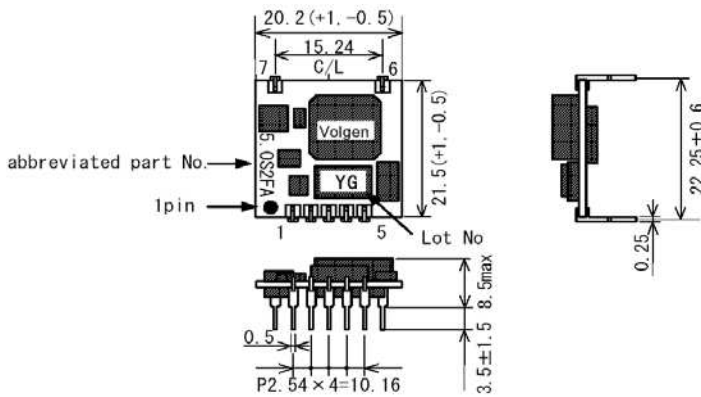

Figure2

pin	Function
1	ON/OFF CONT
2	+Vin
3	GND
4	+Vout
5	+Vout.ADJ
6	NC
7	NC

Dimensions: mm  
Tolerance when nothing specified  $\pm 0.5$   
External resinous coating

[ SMD type ]  
VSI-5.0S2R0SMA  
( for order received product )

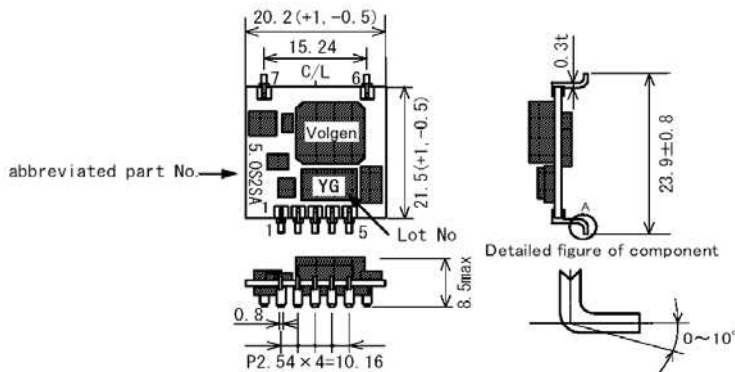

Figure3

pin	Function
1	ON/OFF CONT
2	+Vin
3	GND
4	+Vout
5	+Vout.ADJ
6	NC
7	NC

Dimensions : mm  
Tolerance when nothing specified  $\pm 0.5$   
Without coating.  
( for adsorption mounter air )

<Block Diagram>

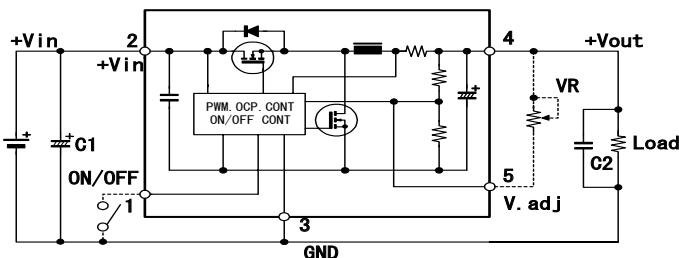

Figure4

- Use this model according to a usual three terminal regulator.
- Output Voltage  
5pin Open= +5V (rating output voltage)
- C1 : More than 100 $\mu$ F (In order to reduce the line impedance)
- C2 : Output capacitor built-in.  
In case that the wiring is long to the load, output noise may be further reduced with the 2.2 $\mu$ F~4.7 $\mu$ F added.
- Refer to figure 6~8 about :  
adjustment output voltage, on/off control.
- Refer to page 6 about :  
over-current protection, soldering conditions, and cleaning conditions.