



**Miniatur Radial Gebläse**  
**Miniature Radial Blower**  
**Ventilateur miniature radial**



U71HX-024KX-6

24VDC

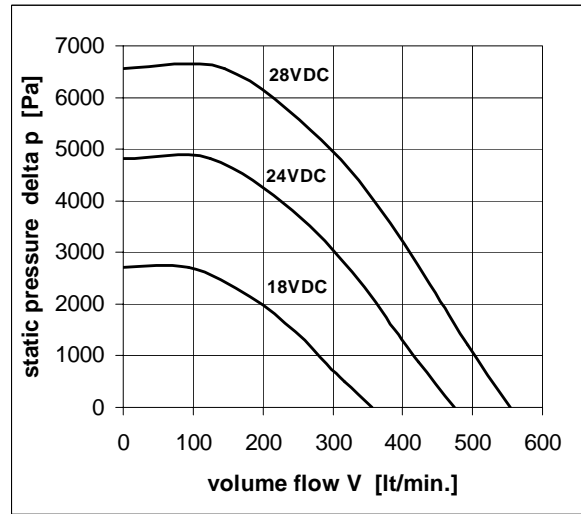

U71HX

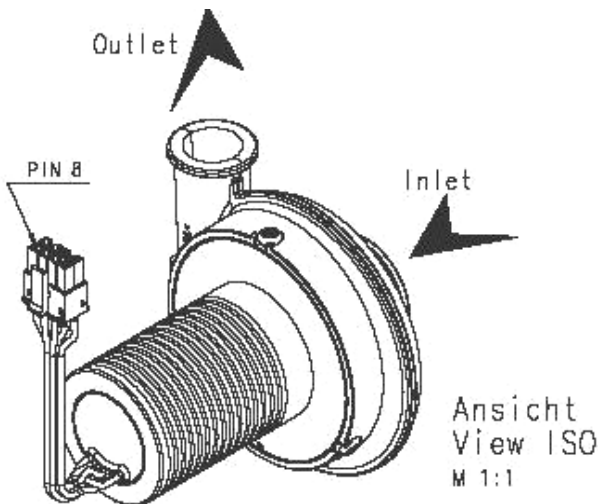

**Steckerbelegung / connector pin assignment**

Pin 1	Hall sensor 1*	blue	AWG24
Pin 2	Hall sensor 2*	black	AWG24
Pin 3	Vhal 4.5...24VDC	yellow	AWG24
Pin 4	Motorwinding 3	orange	AWG24
Pin 5	Hall sensor 3*	grey	AWG24
Pin 6	GND	green	AWG24
Pin 7	Motorwinding 1	brown	AWG24
Pin 8	Motorwinding 2	red	AWG24

\* internal Pull-up (7...13 kohm) to Pin 3

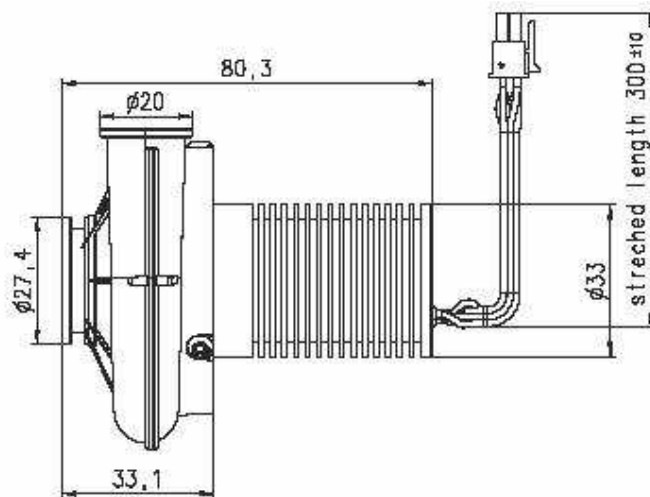
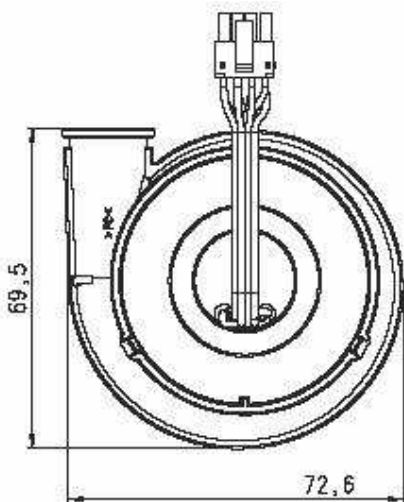

## Technische Daten

## Technical data

## Caractéristiques techniques

### Motor

elektronisch kommutierter Motor (mit Hallsensoren) ohne integrierte Elektronik (externe Elektronik nötig).

### Motor

electronically commutated motor (with hall sensors) without integrated motor controller (external driver required)























### Moteur

moteur à commutation électronique (avec hall sensor) sans électronique intégré (électronique externe indispensable)

Standardluftdichte 1.2kg/m<sup>3</sup>

Standard air density 1.2kg/m<sup>3</sup>

Densité de l'air standard 1,2 kg/m<sup>3</sup>

			U71HX-024KX-6	
	U <sub>N</sub>	V	24	
	U	V	15.0 - 28.0	
	I <sub>N</sub> freeblowing	mA	1526	
	I <sub>N</sub> work. point	mA	849	
	I <sub>N</sub> static	mA	552	
	I <sub>block</sub>	A	5	
	P <sub>N</sub> work. point	W	20.37	
	n freeblowing	min <sup>-1</sup>	32345	
	n work. point	min <sup>-1</sup>	33103	
	n static	min <sup>-1</sup>	33473	
	V freeblowing	l/min	474	
	V work. point	l/min	124	
	p work. point	Pa	4814	
	p static	Pa	4819	
	LpA <sub>(WP)</sub>	db(A)	49 dB(A) at 1000 Pa (10 mbar) and 1m distance	
	MTTF <sub>(WP)</sub>	hr	20'000 / 25°C	
	T	°C/°F	-20...+45 / -5...+113	
	m	gr/oz	180 / 6.35	
	Leads	mm/inch	300 / 11.8 (AWG24) / Connector Molex Microfit 43025-0800	
	Housing Material		PC / Impeller PA6	
	Sleeve Bearing		N/A	N/A
	Ball Bearing		•	•
	Tacho		•	•

Datas of Blower were measured with controll board H015X-522A9