

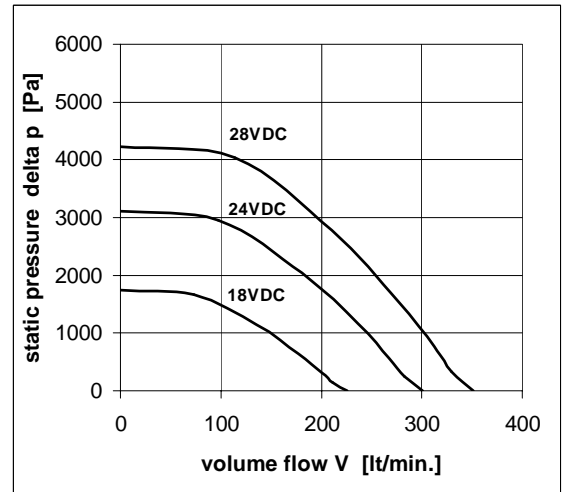

Miniatur Radial Gebläse
Miniature Radial Blower
Ventilateur miniature radial



U65MX-024KX-5 24VDC



U65MX

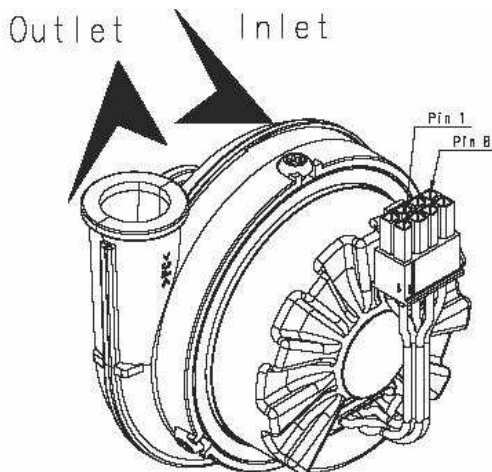

Steckerbelegung / connector pin assignment

Pin 1	Hall sensor 1	blue	AWG24
Pin 2	Hall sensor 2	black	AWG24
Pin 3	Vhal 2.2...18VDC	yellow	AWG24
Pin 4	Motorwinding 3	orange	AWG24
Pin 5	Hall sensor 3	grey	AWG24
Pin 6	GND	green	AWG24
Pin 7	Motorwinding 1	brown	AWG24
Pin 8	Motorwinding 2	red	AWG24

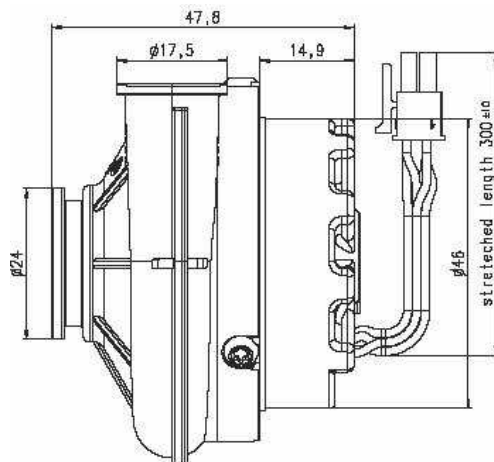
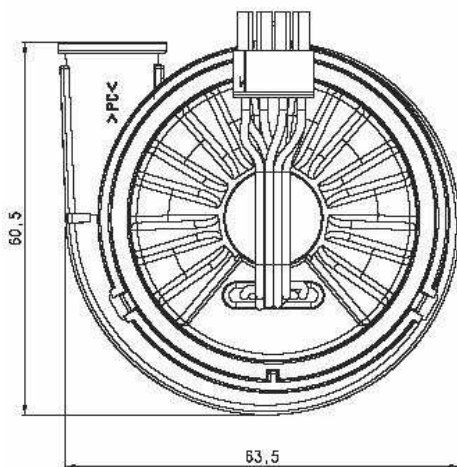

Technische Daten

Technical data

Caractéristiques techniques

Motor

elektronisch kommutierter Motor (mit Hallsensoren) ohne integrierte Elektronik (externe Elektronik nötig).

Standardluftdichte 1.2kg/m³

Motor























electronically commutated motor (with hall sensors) without integrated motor controller (external driver required)

Standard air density 1.2kg/m³

Moteur

moteur à commutation électronique (avec hall sensor) sans électronique intégré (électronique externe indispensable)

Densité de l'air standard 1,2 kg/m³

			U65MX-024KX-5
	U _N	V	24
	U	V	15.0 - 28.0
	I _N freeblowing	mA	766
	I _N work. point	mA	535
	I _N static	mA	411
	I _{block}	A	5
	P _N work. point	W	12.83
	n freeblowing	min ⁻¹	29593
	n work. point	min ⁻¹	30418
	n static	min ⁻¹	30612
	V freeblowing	l/min	301
	V work. point	l/min	97
	p work. point	Pa	2961
	p static	Pa	3103
	LpA _(WP)	db(A)	47.5 dB(A) at 1000 Pa (10 mbar) and 1m distance
	MTTF _(WP)	hr	20'000 / 25°C
	T	°C/°F	-20...+45 / -5...+113
	m	gr/oz	168 / 5.92
	Leads	mm/inch	300 / 11.8 (AWG24) / Connector Molex Microfit 43025-0800
	Housing Material		PC / Impeller PA6
	Sleeve Bearing		N/A
	Ball Bearing		•
	Tacho		•

Datas of Blower were measured with controll board H015X-522A9