

Flachl fter
Ultra Slim Fans
Ventilateur Ultra Plats



SN EN ISO 9001 CERTIFICATED

F16LM-9

3 VDC



U16LM-9



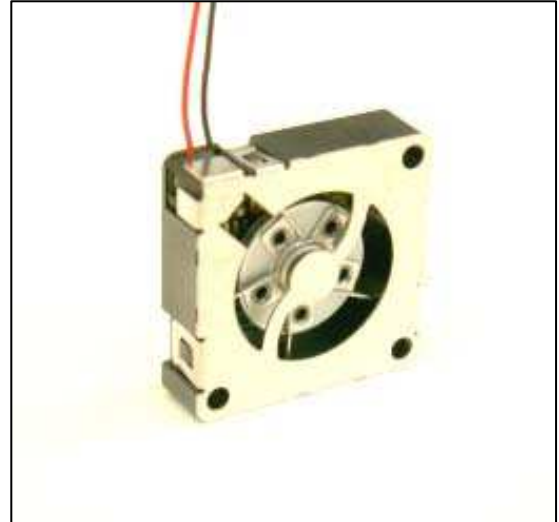



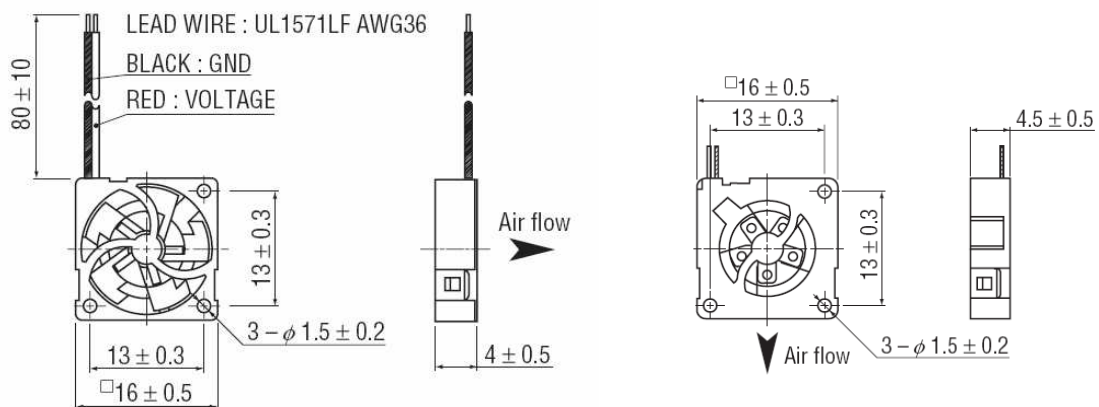
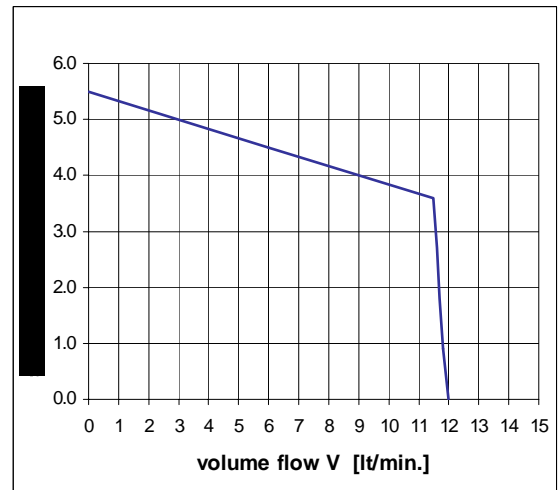
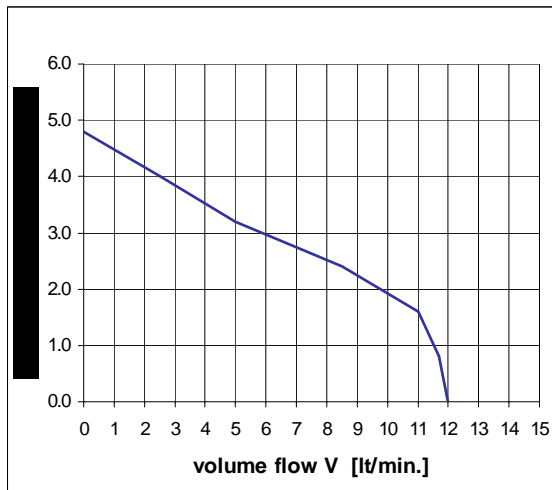













5 VDC



F16 / U16



Technische Daten
F16 = miniatur Flachlüfter
U16 = miniature radial Lüfter
Technical data
F16 = ultra small axial fan
U16 = ultra small radial blower
Carateristiques techniques
F16 = ventilateur axial ultra plat
U16 = ventilateur radial ultra plat

			F16LM	U16LM
	U _N	V	3	5
	U	V	3.3 – 3.5	4.5 – 5.5
	I _{max}	mA	20	40
	I _{block}	mA	0	
	P _N	W	0.07	0.2
	n	min ⁻¹	6500	6000
	V	l/min	12	12
	p	Pa	4.7	5.5
	LpA	db(A)	3	3
	MTTF	hr	10'000 / 25°C	
	T	°C/°F	0...+60 / 32...+140	
	m	gr/oz	1.3 / 0.06	
	M	mm/inch	80/3.15 (AWG36)	
	PC		SUS, LCP reinforced (UL94V-0)	
	sleeve bearing		O	
	ball bearing		-	
	Option/Tacho/NOS		-	
	Attachment		-	
	Attachment		-	
	Attachment		-	