

IP3253/54CZ8/CZ12/CZ16

Integrated 4-, 6- and 8-channel passive EMI-filter network with high level ESD protection to IEC 61000-4-2 level 4

Rev. 03 — 23 March 2010

Objective data sheet

1. Product profile

1.1 General description

The IP3253/54CZ8/CZ12/CZ16 family consists of 4-, 6- and 8-channel LC low-pass filter arrays designed to filter unwanted RF signals on the I/O ports of portable communication and computing devices. In addition, the IP3253/54CZ8/CZ12/CZ16 family incorporates diodes which protect downstream components from ElectroStatic Discharge (ESD) voltages up to ± 15 kV.

These devices are fabricated using monolithic silicon technology integrating up to 8 inductors and 16 diodes in a 0.4 mm pitch 8-, 12- or 16-pin ultra-thin leadless plastic package, compatible with QFN.

1.2 Features

- Pb-free and Restriction of Hazardous Substances (RoHS) compliant
- 4-, 6- and 8-channel integrated π -type LC filter network
- ESD protection to ± 15 kV contact discharge according to IEC 61000-4-2, level 4
- ESD protection to ± 30 kV contact discharge according to MIL-STD-883 (Method 3015) Human Body Model
- UTLP (QFN compatible) plastic package with 0.4 mm pitch and 0.5 mm height

1.3 Applications

- General purpose ElectroMagnetic Interference (EMI), Radio-Frequency Interference (RFI) filtering and downstream ESD protection for:
 - ◆ Cellular phone and Personal Communication System (PCS) mobile handsets
 - ◆ Cordless telephones
 - ◆ Wireless data (WAN/LAN) systems

2. Pinning information

Table 1. Pinning IP3253/54CZ8/CZ12/CZ16

Pin	Description	Simplified outline	Symbol
CZ8			
1 and 8	filter channel 1	<p>Transparent top view</p>	<p>001aaJ745</p>
2 and 7	filter channel 2		
3 and 6	filter channel 3		
4 and 5	filter channel 4		
ground pad	ground		
CZ12			
1 and 12	filter channel 1	<p>Transparent top view</p>	<p>001aaJ746</p>
2 and 11	filter channel 2		
3 and 10	filter channel 3		
4 and 9	filter channel 4		
5 and 8	filter channel 5		
6 and 7	filter channel 6		
ground pad	ground		
CZ16			
1 and 16	filter channel 1	<p>Transparent top view</p>	<p>001aaJ747</p>
2 and 15	filter channel 2		
3 and 14	filter channel 3		
4 and 13	filter channel 4		
5 and 12	filter channel 5		
6 and 11	filter channel 6		
7 and 10	filter channel 7		
8 and 9	filter channel 8		
ground pad	ground		

3. Ordering information

Table 2. Ordering information

Type number	Package		Version
	Name	Description	
IP3253CZ8-4	HXSON8U	plastic thermal enhanced extremely thin small outline package; no leads; 8 terminals; UTLP based; body 1.35 × 1.7 × 0.5 mm	SOT983-1
IP3253CZ12-6	HXSON12U	plastic thermal enhanced extremely thin small outline package; no leads; 12 terminals; UTLP based; body 1.35 × 2.5 × 0.5 mm	SOT984-1
IP3253CZ16-8	HXSON16U	plastic thermal enhanced extremely thin small outline package; no leads; 16 terminals; UTLP based; body 1.35 × 3.3 × 0.5 mm	SOT985-1
IP3254CZ8-4	HXSON8U	plastic thermal enhanced extremely thin small outline package; no leads; 8 terminals; UTLP based; body 1.35 × 1.7 × 0.5 mm	SOT983-1
IP3254CZ12-6	HXSON12U	plastic thermal enhanced extremely thin small outline package; no leads; 12 terminals; UTLP based; body 1.35 × 2.5 × 0.5 mm	SOT984-1
IP3254CZ16-8	HXSON16U	plastic thermal enhanced extremely thin small outline package; no leads; 16 terminals; UTLP based; body 1.35 × 3.3 × 0.5 mm	SOT985-1

4. Limiting values

Table 3. Limiting values

In accordance with the Absolute Maximum Rating System (IEC 60134).

Symbol	Parameter	Conditions	Min	Max	Unit
V _{CC}	supply voltage		-0.5	+5.6	V
V _{ESD}	electrostatic discharge voltage	all pins to ground; contact discharge			
		Human Body Model; MIL-STD-883, Method 3015	-30	+30	kV
		IEC 61000-4-2, level 4	[1] -15	+15	kV
I _{ch}	channel current (DC)	T _{amb} = 85 °C			
		IP3253CZ8/CZ12/CZ16	-	30	mA
		IP3254CZ8/CZ12/CZ16	-	30	mA
P _{ch}	channel power dissipation	IP3253CZ8/CZ12/CZ16	-	10	mW
		IP3254CZ8/CZ12/CZ16	-	10	mW
P _{tot/pack}	total power dissipation per package	T _{amb} = 85 °C	-	500	mW
T _{stg}	storage temperature		-65	+150	°C
T _{amb}	ambient temperature		-40	+85	°C

[1] Device tested with 1000 pulses of ±15 kV contact discharges, according to the IEC 61000-4-2 model, which far exceed IEC 61000-4-2 level 4 (8 kV contact discharge).

5. Characteristics

Table 4. Channel characteristics

$T_{amb} = 25\text{ }^{\circ}\text{C}$ unless otherwise specified.

Symbol	Parameter	Conditions	Min	Typ	Max	Unit	
$L_{s(ch)}$	channel series inductance	IP3253CZ8/CZ12/CZ16	-	18	-	nH	
		IP3254CZ8/CZ12/CZ16	-	18	-	nH	
C_{ch}	channel capacitance	for the total channel; $f_i = 100\text{ kHz}$					
		IP3253CZ8/CZ12/CZ16					
		$V_{bias(DC)} = 2.5\text{ V}$	[1] 20	25	30	pF	
		$V_{bias(DC)} = 0\text{ V}$	[1] 34	43	52	pF	
		IP3254CZ8/CZ12/CZ16					
		$V_{bias(DC)} = 2.5\text{ V}$	[1] 25	33	40	pF	
	$V_{bias(DC)} = 0\text{ V}$	[1] 38	50	60	pF		
I_{LR}	reverse leakage current	per channel; $V_I = 3.5\text{ V}$	-	-	0.1	μA	
V_{BR}	breakdown voltage	positive clamp; $I_I = 1\text{ mA}$	5.8	-	10	V	
V_F	forward voltage	negative clamp; $I_F = -1\text{ mA}$	-1.5	-	-0.4	V	
$R_{(ch-ch)}$	resistance between channels	$V_I = 3.5\text{ V}$	10	-	-	$\text{M}\Omega$	
$R_{s(ch)}$	channel series resistance		-	8	-	Ω	

[1] Guaranteed by design.

Table 5. Frequency characteristics

$T_{amb} = 25\text{ }^{\circ}\text{C}$ unless otherwise specified.

Symbol	Parameter	Conditions	Min	Typ	Max	Unit
α_{il}	insertion loss	$R_{source} = 50\ \Omega$; $R_L = 50\ \Omega$; $1\text{ GHz} < f_i < 4\text{ GHz}$	-	30	-	dB
f_{-3dB}	cut-off frequency	$R_{source} = 50\ \Omega$; $R_L = 50\ \Omega$; $V_I = 0\text{ V}$				
		IP3253CZ8/CZ12/CZ16	-	175	-	MHz
		IP3254CZ8/CZ12/CZ16	-	145	-	MHz
$f_{rolloff}$	roll-off frequency	measured at 6 dB attenuation; $R_{source} = 50\ \Omega$; $R_L = 50\ \Omega$; $V_I = 0\text{ V}$				
		IP3253CZ8/CZ12/CZ16	-	350	-	MHz
		IP3254CZ8/CZ12/CZ16	-	315	-	MHz

6. Application information

6.1 Insertion loss

The devices are specifically designed as EMI/RFI filters for multichannel interfaces.

The block schematic for measuring insertion loss in a $50\ \Omega$ system is shown in [Figure 1](#). An example of the measurement curves for all channels is shown in [Figure 2](#).

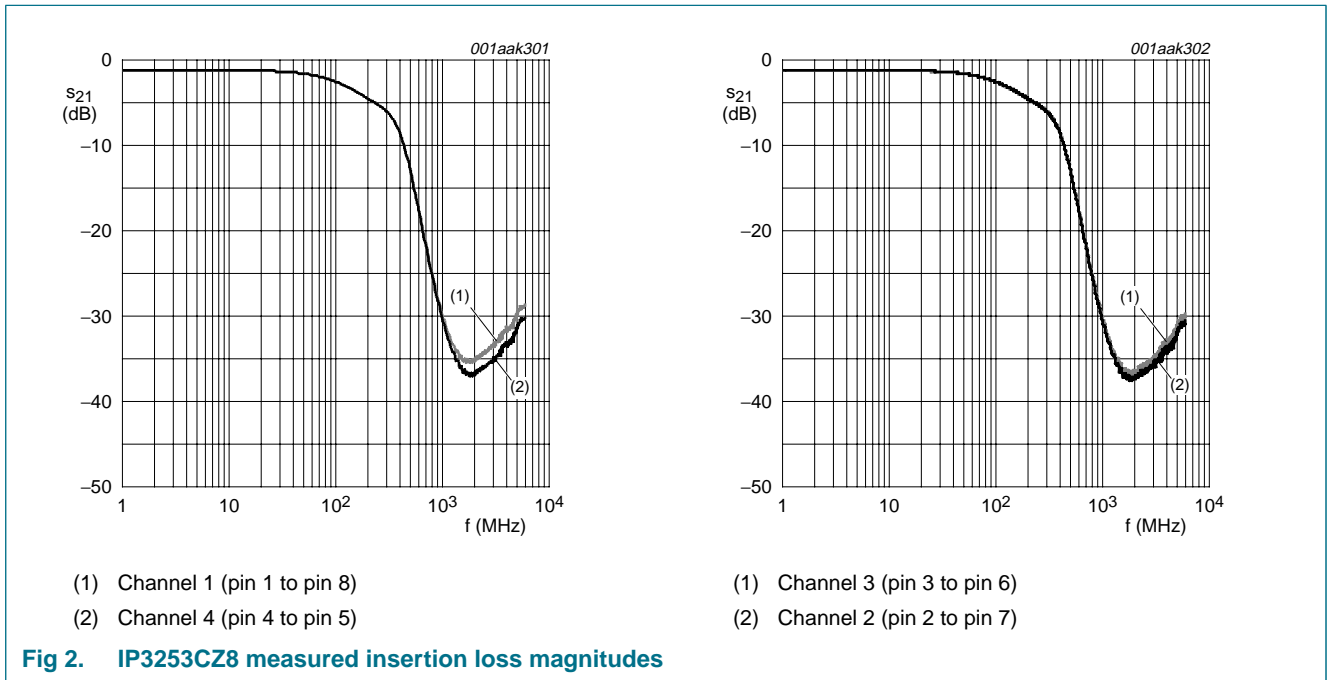
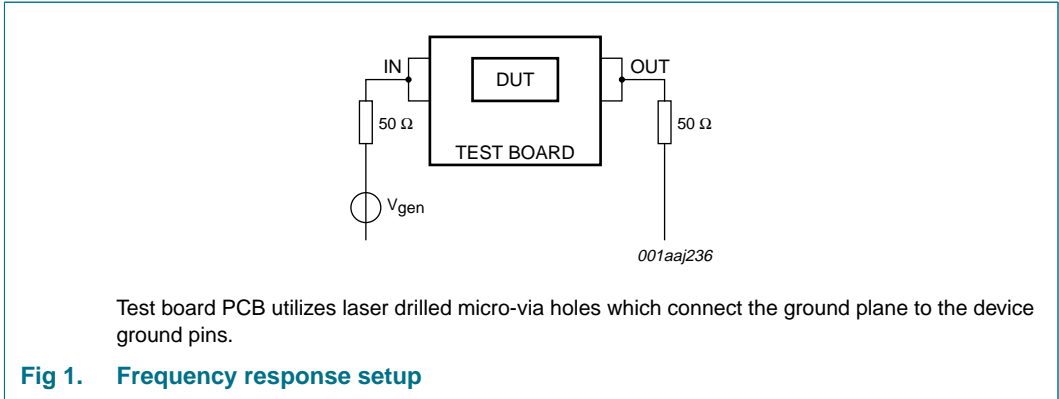

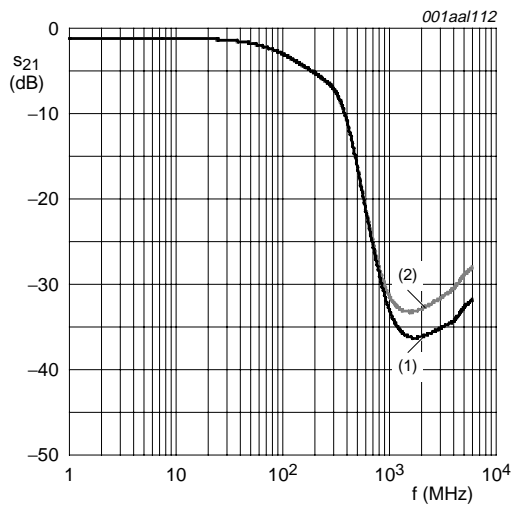

- (1) Channel 1 (pin 1 to pin 8)
- (2) Channel 4 (pin 4 to pin 5)

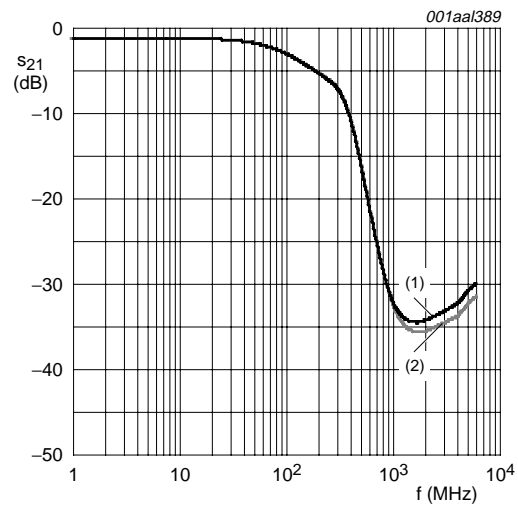

- (1) Channel 3 (pin 3 to pin 6)
- (2) Channel 2 (pin 2 to pin 7)

Fig 3. IP3254CZ8 measured insertion loss magnitudes

7. Package outline

HXSON8U: plastic thermal enhanced extremely thin small outline package; no leads;
8 terminals; UTLP based; body 1.35 x 1.7 x 0.5 mm

SOT983-1

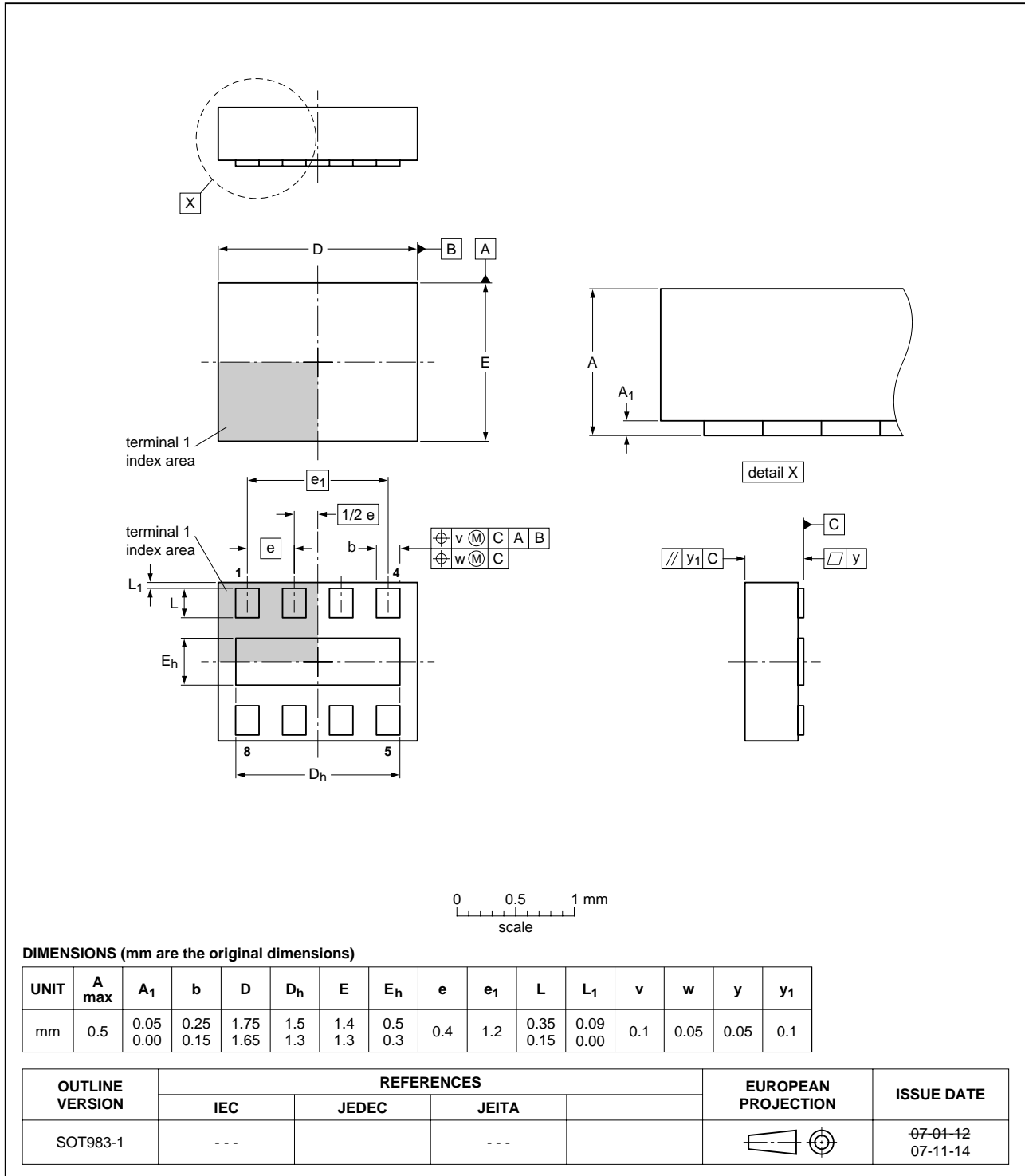

Fig 4. Package outline SOT983-1 (HXSON8U)

HXSON12U: plastic thermal enhanced extremely thin small outline package; no leads; 12 terminals; UTLP based; body 1.35 x 2.5 x 0.5 mm

SOT984-1

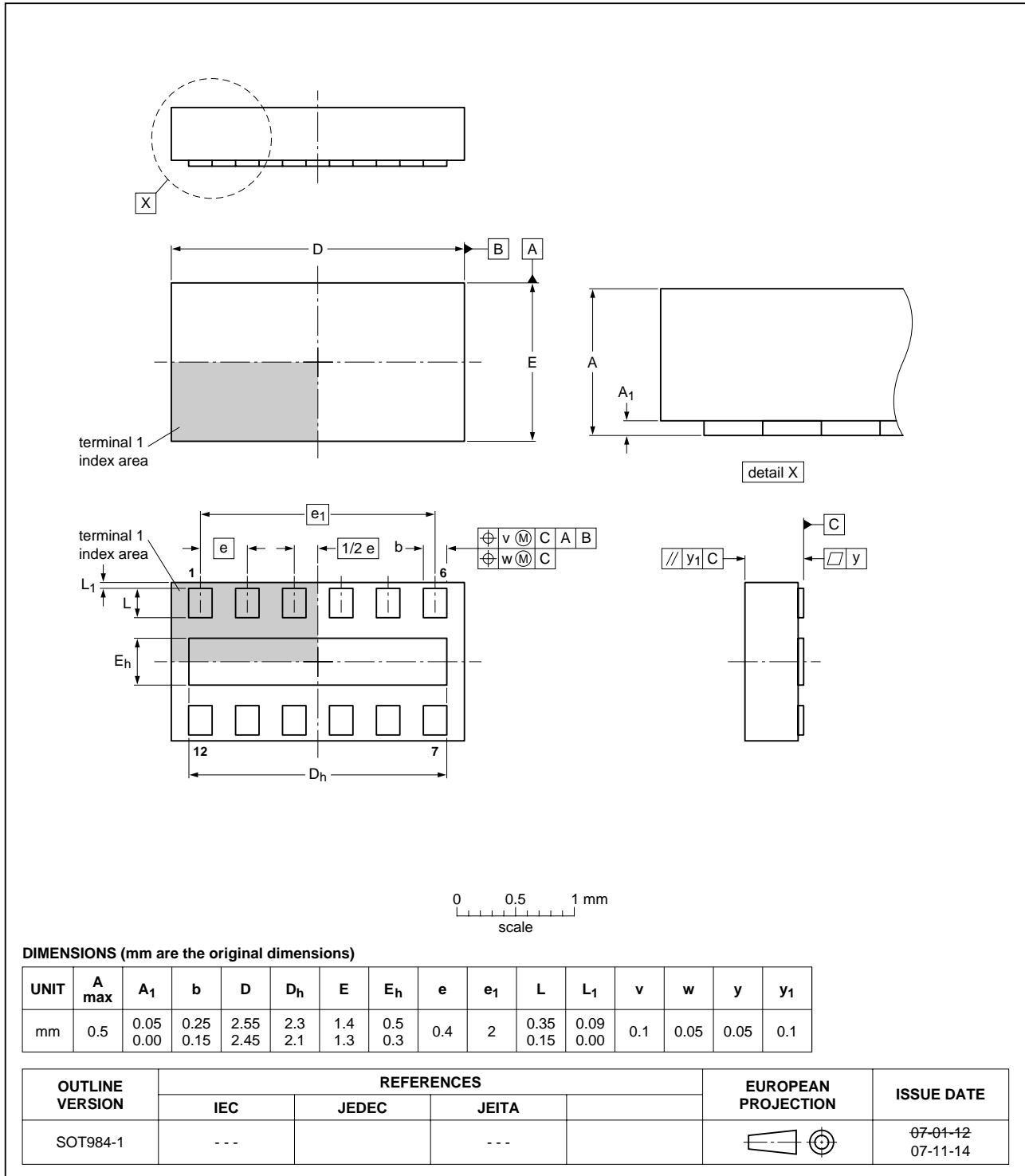

Fig 5. Package outline SOT984-1 (HXSON12U)

HXSON16U: plastic thermal enhanced extremely thin small outline package; no leads;
16 terminals; UTLP based; body 1.35 x 3.3 x 0.5 mm

SOT985-1

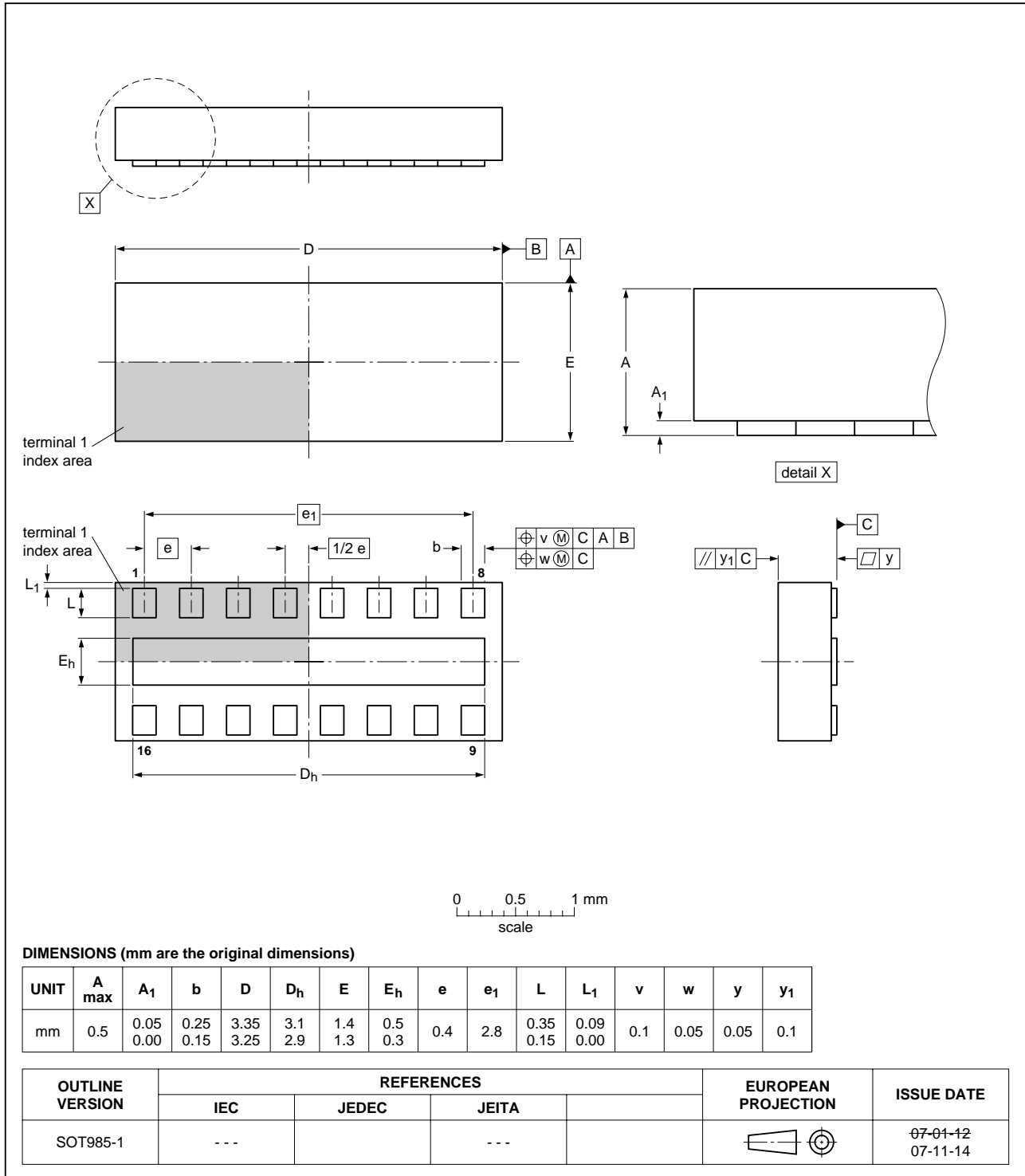

Fig 6. Package outline SOT985-1 (HXSON16U)

8. Abbreviations

Table 6. Abbreviations

Acronym	Description
DUT	Device Under Test
EMI	ElectroMagnetic Interference
ESD	ElectroStatic Discharge
LAN	Local Area Network
PCB	Printed-Circuit Board
PCS	Personal Communication System
QFN	Quad Flat No leads
RFI	Radio Frequency Interference
RoHS	Restriction of Hazardous Substances
UTLP	Ultra-Thin Leadless Package
WAN	Wide Area Network

9. Revision history

Table 7. Revision history

Document ID	Release date	Data sheet status	Change notice	Supersedes
IP3253_54CZ8_CZ12_CZ16_3	20100323	Objective data sheet	-	IP3253CZ8_CZ12_CZ16_2
Modifications:	<ul style="list-style-type: none"> Added type numbers IP3254CZ8, IP3254CZ12 and IP3254CZ16 			
IP3253CZ8_CZ12_CZ16_2	20091016	Objective data sheet	-	IP3253CZ8_CZ12_CZ16_1
IP3253CZ8_CZ12_CZ16_1	20090514	Objective data sheet	-	-

10. Legal information

10.1 Data sheet status

Document status ^{[1][2]}	Product status ^[3]	Definition
Objective [short] data sheet	Development	This document contains data from the objective specification for product development.
Preliminary [short] data sheet	Qualification	This document contains data from the preliminary specification.
Product [short] data sheet	Production	This document contains the product specification.

[1] Please consult the most recently issued document before initiating or completing a design.

[2] The term 'short data sheet' is explained in section "Definitions".

[3] The product status of device(s) described in this document may have changed since this document was published and may differ in case of multiple devices. The latest product status information is available on the Internet at URL <http://www.nxp.com>.

10.2 Definitions

Draft — The document is a draft version only. The content is still under internal review and subject to formal approval, which may result in modifications or additions. NXP Semiconductors does not give any representations or warranties as to the accuracy or completeness of information included herein and shall have no liability for the consequences of use of such information.

Short data sheet — A short data sheet is an extract from a full data sheet with the same product type number(s) and title. A short data sheet is intended for quick reference only and should not be relied upon to contain detailed and full information. For detailed and full information see the relevant full data sheet, which is available on request via the local NXP Semiconductors sales office. In case of any inconsistency or conflict with the short data sheet, the full data sheet shall prevail.

Product specification — The information and data provided in a Product data sheet shall define the specification of the product as agreed between NXP Semiconductors and its customer, unless NXP Semiconductors and customer have explicitly agreed otherwise in writing. In no event however, shall an agreement be valid in which the NXP Semiconductors product is deemed to offer functions and qualities beyond those described in the Product data sheet.

10.3 Disclaimers

Limited warranty and liability — Information in this document is believed to be accurate and reliable. However, NXP Semiconductors does not give any representations or warranties, expressed or implied, as to the accuracy or completeness of such information and shall have no liability for the consequences of use of such information.

In no event shall NXP Semiconductors be liable for any indirect, incidental, punitive, special or consequential damages (including - without limitation - lost profits, lost savings, business interruption, costs related to the removal or replacement of any products or rework charges) whether or not such damages are based on tort (including negligence), warranty, breach of contract or any other legal theory.

Notwithstanding any damages that customer might incur for any reason whatsoever, NXP Semiconductors' aggregate and cumulative liability towards customer for the products described herein shall be limited in accordance with the *Terms and conditions of commercial sale* of NXP Semiconductors.

Right to make changes — NXP Semiconductors reserves the right to make changes to information published in this document, including without limitation specifications and product descriptions, at any time and without notice. This document supersedes and replaces all information supplied prior to the publication hereof.

Suitability for use — NXP Semiconductors products are not designed, authorized or warranted to be suitable for use in medical, military, aircraft, space or life support equipment, nor in applications where failure or

malfunction of an NXP Semiconductors product can reasonably be expected to result in personal injury, death or severe property or environmental damage. NXP Semiconductors accepts no liability for inclusion and/or use of NXP Semiconductors products in such equipment or applications and therefore such inclusion and/or use is at the customer's own risk.

Applications — Applications that are described herein for any of these products are for illustrative purposes only. NXP Semiconductors makes no representation or warranty that such applications will be suitable for the specified use without further testing or modification.

NXP Semiconductors does not accept any liability related to any default, damage, costs or problem which is based on a weakness or default in the customer application/use or the application/use of customer's third party customer(s) (hereinafter both referred to as "Application"). It is customer's sole responsibility to check whether the NXP Semiconductors product is suitable and fit for the Application planned. Customer has to do all necessary testing for the Application in order to avoid a default of the Application and the product. NXP Semiconductors does not accept any liability in this respect.

Limiting values — Stress above one or more limiting values (as defined in the Absolute Maximum Ratings System of IEC 60134) will cause permanent damage to the device. Limiting values are stress ratings only and (proper) operation of the device at these or any other conditions above those given in the Recommended operating conditions section (if present) or the Characteristics sections of this document is not warranted. Constant or repeated exposure to limiting values will permanently and irreversibly affect the quality and reliability of the device.

Terms and conditions of commercial sale — NXP Semiconductors products are sold subject to the general terms and conditions of commercial sale, as published at <http://www.nxp.com/profile/terms>, unless otherwise agreed in a valid written individual agreement. In case an individual agreement is concluded only the terms and conditions of the respective agreement shall apply. NXP Semiconductors hereby expressly objects to applying the customer's general terms and conditions with regard to the purchase of NXP Semiconductors products by customer.

No offer to sell or license — Nothing in this document may be interpreted or construed as an offer to sell products that is open for acceptance or the grant, conveyance or implication of any license under any copyrights, patents or other industrial or intellectual property rights.

Export control — This document as well as the item(s) described herein may be subject to export control regulations. Export might require a prior authorization from national authorities.

Non-automotive qualified products — Unless this data sheet expressly states that this specific NXP Semiconductors product is automotive qualified, the product is not suitable for automotive use. It is neither qualified nor tested in accordance with automotive testing or application requirements. NXP Semiconductors accepts no liability for inclusion and/or use of non-automotive qualified products in automotive equipment or applications.

In the event that customer uses the product for design-in and use in automotive applications to automotive specifications and standards, customer (a) shall use the product without NXP Semiconductors' warranty of the

product for such automotive applications, use and specifications, and (b) whenever customer uses the product for automotive applications beyond NXP Semiconductors' specifications such use shall be solely at customer's own risk, and (c) customer fully indemnifies NXP Semiconductors for any liability, damages or failed product claims resulting from customer design and use of the product for automotive applications beyond NXP Semiconductors' standard warranty and NXP Semiconductors' product specifications.

10.4 Trademarks

Notice: All referenced brands, product names, service names and trademarks are the property of their respective owners.

11. Contact information

For more information, please visit: <http://www.nxp.com>

For sales office addresses, please send an email to: salesaddresses@nxp.com

12. Contents

1 Product profile 1

1.1 General description 1

1.2 Features 1

1.3 Applications 1

2 Pinning information 2

3 Ordering information 3

4 Limiting values 3

5 Characteristics 4

6 Application information 4

6.1 Insertion loss 4

7 Package outline 7

8 Abbreviations 10

9 Revision history 10

10 Legal information 11

10.1 Data sheet status 11

10.2 Definitions 11

10.3 Disclaimers 11

10.4 Trademarks 12

11 Contact information 12

12 Contents 13

Please be aware that important notices concerning this document and the product(s) described herein, have been included in section 'Legal information'.

