

Harvatek Surface Mount LEDs Approval Sheet F1071SP Series

Official Product	HT Part No. F1071SP Series		
Tentative Product	*****	*****	
Specifications are subject to changes for improvement without advance notice. Proprietary data, drawings, company confidential all rights reserved.	10/16/2013	Version of 1.0	Page 1/18

DISCLAIMER	3
LIFE SUPPORT POLICY	3
PRODUCT SPECIFICATION	4
ATTENTION: ELECTROSTATIC DISCHARGE (ESD) PROTECTION	4
LABEL SPECIFICATIONS:	5
SPECIFICATIONS RANGE	6
CHROMATICITY COORDINATE:	8
PRODUCT FEATURES	10
ELECTRO-OPTICAL CHARACTERISTICS	10
PACKAGE OUTLINE DIMENSION AND RECOMMENDED SOLDERING PATTERN FOR REFLOW SOLDERING	10
ABSOLUTE MAXIMUM RATINGS	10
CHARACTERISTICS OF F1071SP.....	11
PRECAUTION FOR USE	12
PACKAGING	13
TAPE DIMENSION	13
REEL DIMENSION	14
PACKING	14
DRY PACK.....	15
BAKING	15
PRECAUTIONS	15
HANDLING OF SILICONE RESIN LEDS	16
REFLOW SOLDERING	17
REWORKING	17
CLEANING	17
REVISION HISTORY	18

Official Product	HT Part No. F1071SP Series		
Tentative Product	*****	*****	
Specifications are subject to changes for improvement without advance notice. Proprietary data, drawings, company confidential all rights reserved.	10/16/2013	Version of 1.0	Page 2/18

DISCLAIMER

HARVATEK reserves the right to make changes without further notice to any products herein to improve reliability, function or design. HARVATEK does not assume any liability arising out of the application or use of any product or circuit described herein; neither does it convey any license under its patent rights, nor the rights of others.

Life Support Policy

HARVATEK's products are not authorized for use as critical components in life support devices or systems without the express written approval of the President of HARVATEK or HARVATEK INTERNATIONAL. As used herein:

1. Life support devices or systems are devices or systems which, (a) are intended for surgical implant into the body, or (b) support or sustain life, and (c) whose failure to perform when properly used in accordance with instructions for use provided in the labeling, can be reasonably expected to result in a significant injury of the user.
2. A critical component in any component of a life support device or system whose failure to perform can be reasonably expected to cause the failure of the life support device or system, or to affect its safety or effectiveness.

Official Product	HT Part No. F1071SP Series		
Tentative Product	*****	*****	
Specifications are subject to changes for improvement without advance notice. Proprietary data, drawings, company confidential all rights reserved.	10/16/2013	Version of 1.0	Page 3/18

Product Specification

Item	Specification	Material	Quantity
Luminous Intensity(Iv)	Cool White: 2250~3800 mcd @20mA/ T _S = 25°C ;Tolerance: ± 10%		
Chromaticity Coordinate	As page 7 & 8 @20mA/ T _S = 25°C ;Tolerance: ± 0.005		
Vf	Cool White:2.8~3.5 V (0.1V/Bin) @20mA/ T _S = 25°C ;Tolerance: ± 0.05V		
Ir	< 100 μA @ V _R = 5 V		
Resin	Yellow	Silicon Resin	
Carrier tape	According to EIA 481-1A specs	Conductive black tape	2000pcs per reel
Reel	According to EIA 481-1A specs	Conductive black	
Label	HT standard		
Packing bag	220x240mm	Aluminum laminated bag/ no-zipper	One reel one bag
Carton	HT standard	Paper	Non-specified

Others:

Each immediate box consists of 5 reels. The 5 reels may not necessarily have the same lot number or the same bin combinations of Iv, CIE and Vf. Each reel has a label identifying its specification; the immediate box consists of a product label as well.

Note :This is shipped test conditions

※Remarks: This product should be operated in forward bias. If a reverse voltage is continuously applied to the product, such operation can cause migration resulting in LED damage.

ATTENTION: Electrostatic Discharge (ESD) protection



The symbol to the left denotes that ESD precaution is needed. ESD protection for GaP and AlGaAs based chips is necessary even though they are relatively safe in the presence of low static-electric discharge. Parts built with AlInGaP, GaN, or/and InGaN based chips are **STATIC SENSITIVE devices**. ESD precaution must be taken during design and assembly.

If manual work or processing is needed, please ensure the device is adequately protected from ESD during the process.

Official Product	HT Part No. F1071SP Series		
Tentative Product	*****	*****	
Specifications are subject to changes for improvement without advance notice. Proprietary data, drawings, company confidential all rights reserved.	10/16/2013	Version of 1.0	Page 4/18

Label Specifications:

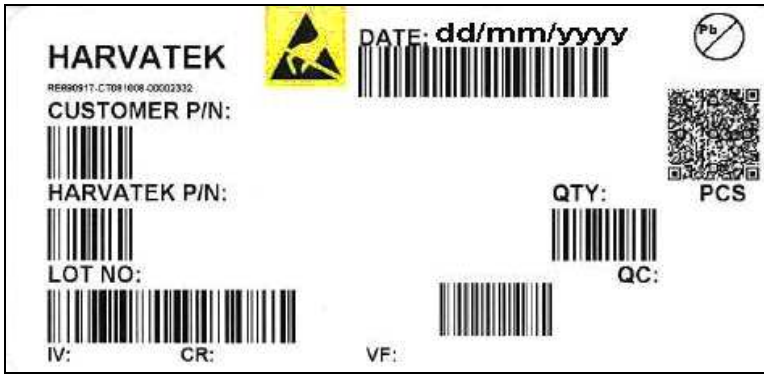

Harvatek P/N

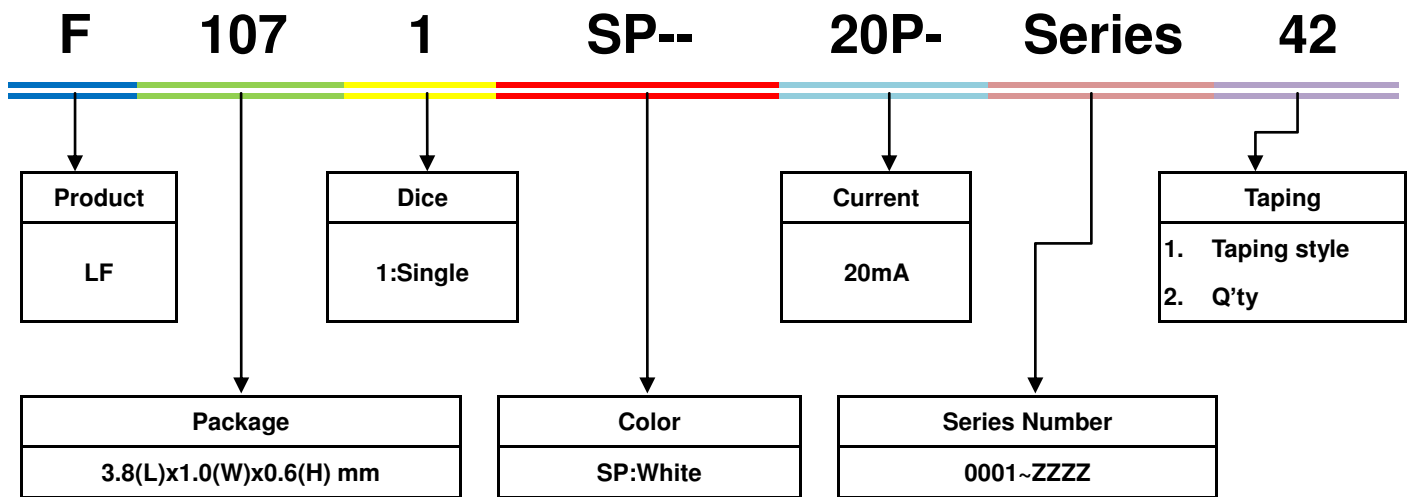

Lot No.:

1	2	3	4	5	6	7	8	9	10
E	1	A	1	A	2	2	L	1	2
Code 1 2		Code 3	Code 4	Code 5	Code 6	Code 7	Code 8	Code 9	Code 10
		Mfg. Year	Mfg. Month	Mfg. Date	Consecutive number		Special code		
Internal Tracing Code		2010-A 2011-B 2012-C 2013-D . .	1:Jan. 2:Feb. ... A:Oct. B:Nov. C:Dec.	1:A 2:B 3:C ... 26:Z 27:7 28:8 29:9 30:3 31:4	01~ZZ		000~ZZZ		

Official Product	HT Part No. F1071SP Series		
Tentative Product	*****	*****	
Specifications are subject to changes for improvement without advance notice. Proprietary data, drawings, company confidential all rights reserved.	10/16/2013	Version of 1.0	Page 5/18

Specifications Range.

■ Luminous Intensity (Iv) Bin:

Color	Bin Code	Spec. Range
SP	Z71	2250~2385 mcd
	Z72	2385~2530 mcd
	Z81	2530~2685 mcd
	Z82	2685~2850 mcd
	Z91	2850~3020 mcd
	Z92	3020~3200 mcd
	ZA1	3200~3400 mcd
	ZA2	3400~3600 mcd
	ZB1	3600~3800 mcd

Note: It maintains a tolerance of $\pm 10\%$ on luminous intensity

Official Product	HT Part No. F1071SP Series		
Tentative Product	*****	*****	
Specifications are subject to changes for improvement without advance notice. Proprietary data, drawings, company confidential all rights reserved.	10/16/2013	Version of 1.0	Page 6/18

■ Color Bin:

	X	Y		X	Y
GCA	0.26	0.25	FCA	0.266	0.242
	0.252	0.236		0.258	0.228
	0.258	0.228		0.264	0.22
	0.266	0.242		0.272	0.234
	0.26	0.25		0.266	0.242
GDA	0.268	0.264	FDA	0.274	0.256
	0.26	0.25		0.266	0.242
	0.266	0.242		0.272	0.234
	0.274	0.256		0.28	0.248
	0.268	0.264		0.274	0.256
GEA	0.276	0.278	FEA	0.282	0.27
	0.268	0.264		0.274	0.256
	0.274	0.256		0.28	0.248
	0.282	0.27		0.288	0.262
	0.276	0.278		0.282	0.27
GHA	0.284	0.292	FHA	0.29	0.284
	0.276	0.278		0.282	0.27
	0.282	0.27		0.288	0.262
	0.29	0.284		0.296	0.276
	0.284	0.292		0.29	0.284
GIA	0.292	0.306	FIA	0.298	0.298
	0.284	0.292		0.29	0.284
	0.29	0.284		0.296	0.276
	0.298	0.298		0.304	0.29
	0.292	0.306		0.298	0.298
GJA	0.3	0.32	FJA	0.306	0.312
	0.292	0.306		0.298	0.298
	0.298	0.298		0.304	0.29
	0.306	0.312		0.312	0.304
	0.3	0.32		0.306	0.312

Official Product	HT Part No. F1071SP Series		
Tentative Product	*****	*****	
Specifications are subject to changes for improvement without advance notice. Proprietary data, drawings, company confidential all rights reserved.	10/16/2013	Version of 1.0	Page 7/18

	X	Y		X	Y
GKA	0.308	0.334	FKA	0.314	0.326
	0.3	0.32		0.306	0.312
	0.306	0.312		0.312	0.304
	0.314	0.326		0.32	0.318
	0.308	0.334		0.314	0.326

Note: It maintains a tolerance of x, y ± 0.005

Chromaticity Coordinate:

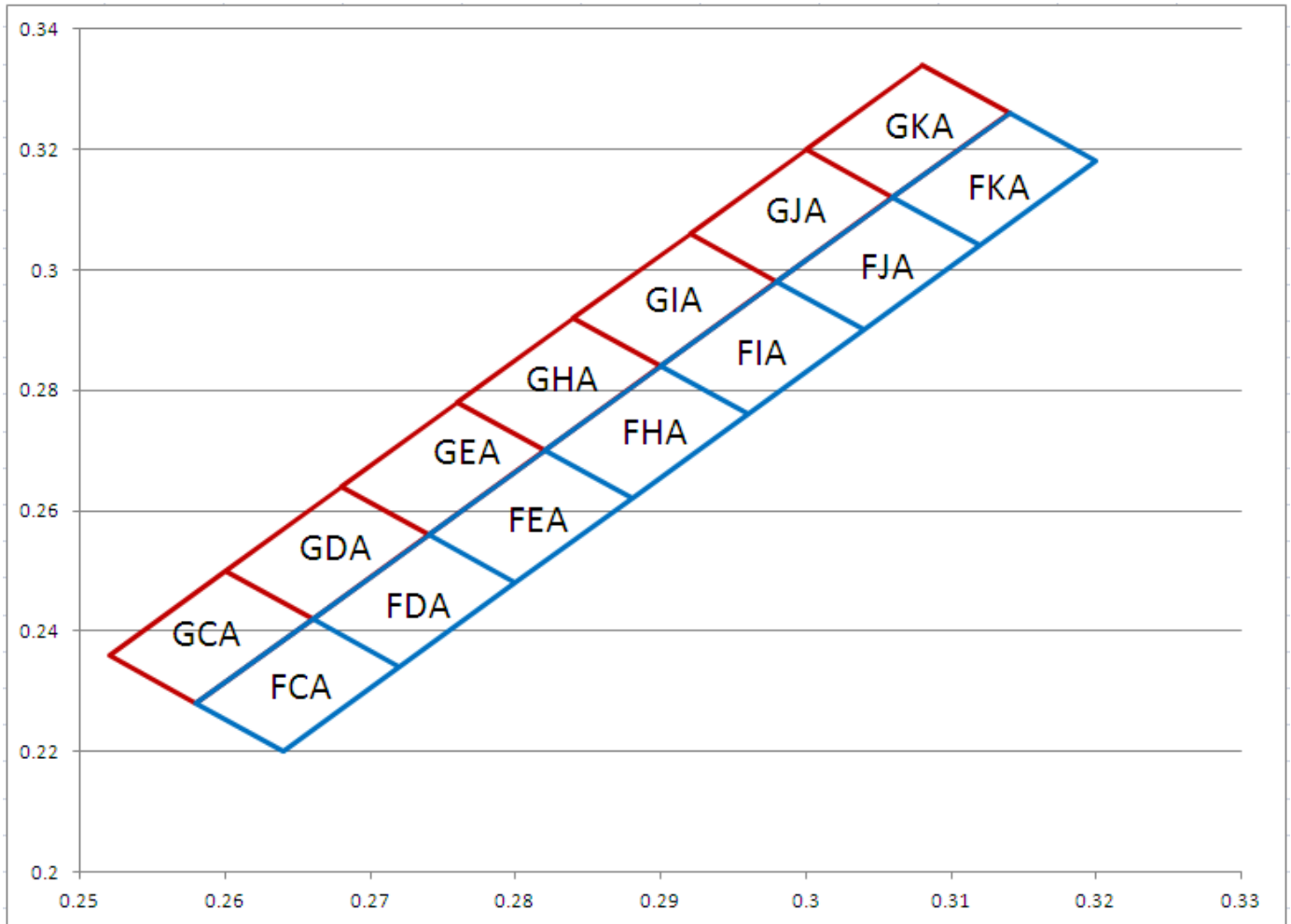

Official Product	HT Part No. F1071SP Series		
Tentative Product	*****	*****	
Specifications are subject to changes for improvement without advance notice. Proprietary data, drawings, company confidential all rights reserved.	10/16/2013	Version of 1.0	Page 8/18

■ Forward Voltage (Vf) Bin:

Color	Bin Code	Spec. Range
SP	H1	2.8-2.9
	H2	2.9-3.0
	H3	3.0-3.1
	H4	3.1-3.2
	J1	3.2-3.3
	J2	3.3-3.4
	J3	3.4~3.5

Note: It maintains a tolerance of $\pm 0.05V$ on forward voltage measurements

Official Product	HT Part No. F1071SP Series		
Tentative Product	*****	*****	
Specifications are subject to changes for improvement without advance notice. Proprietary data, drawings, company confidential all rights reserved.	10/16/2013	Version of 1.0	Page 9/18

Product Features

Electro-Optical Characteristics

(T_{Soldering} ,25 °C)

Series	Emitting Color	Material	V _F (V)		Chromaticity Coordinate x,y	I _v (mcd) Typical	Viewing Angle 2θ $\frac{1}{2}$
			typ	max			
F1071SP	Cool White	InGaN	3.1	3.5	x=0.2900 ,y=0.2800	2850	120

Package Outline Dimension and Recommended Soldering Pattern for Reflow Soldering

(Unit:mm Tolerance: +/-0.1)

Outline Dim.	Soldering Pattern

Soldering terminals may shift in the x, y direction.

Absolute Maximum Ratings

(T_{Soldering} ,25 °C)

Series	P _D (mW)	I _F (mA)	I _{FP} (mA)*	T _{OP} (°C)	T _{ST} (°C)
Color	Power Dissipation	Forward Current	Pulse Forward Current	Operating Temperature	Storage Temperature
SP	70	20	30	-40~+85	-40~+100

* Condition for I_{FP} is pulse of 1/10 duty and 0.1msec width

Official Product	HT Part No. F1071SP Series		
Tentative Product	*****	*****	
Specifications are subject to changes for improvement without advance notice. Proprietary data, drawings, company confidential all rights reserved.	10/16/2013	Version of 1.0	Page 10/18

Characteristics of F1071SP

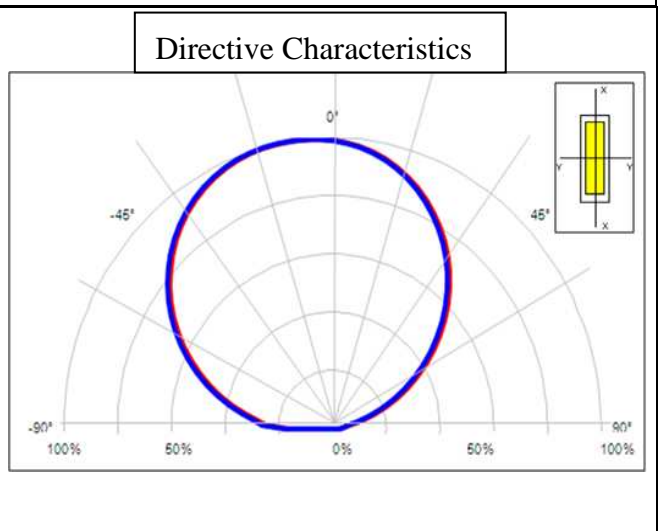
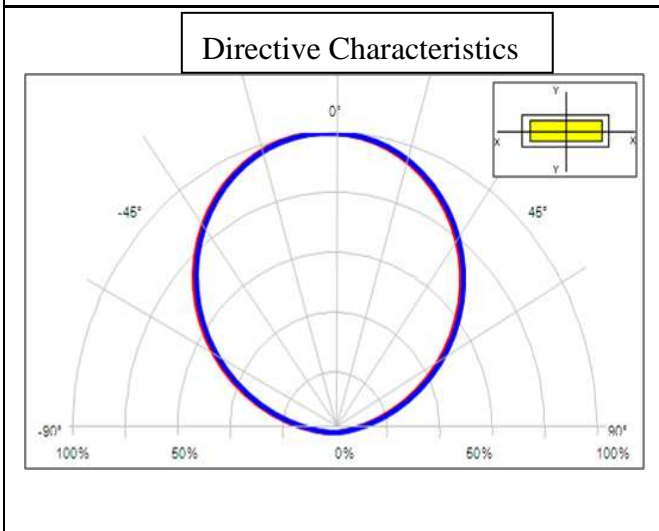
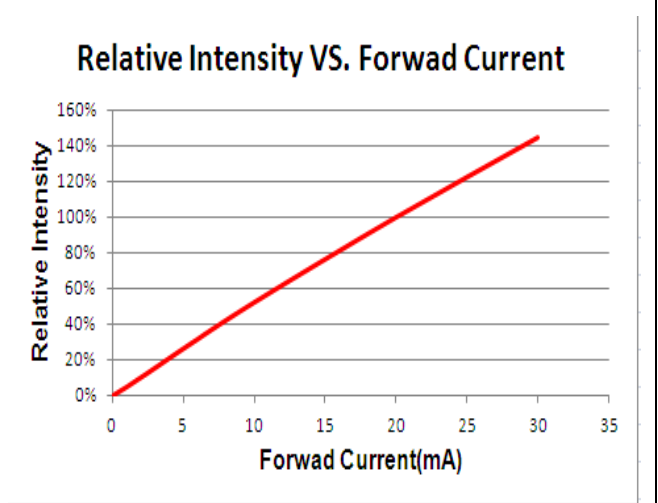
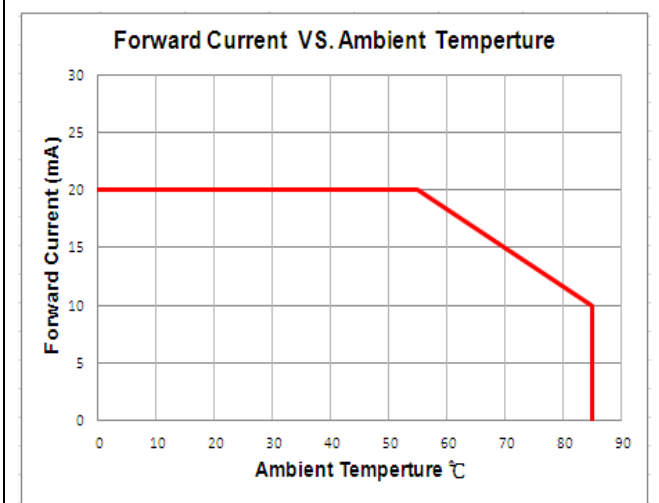
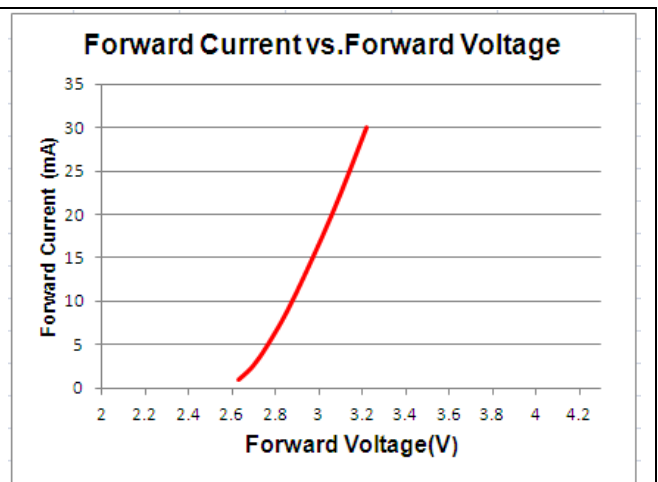
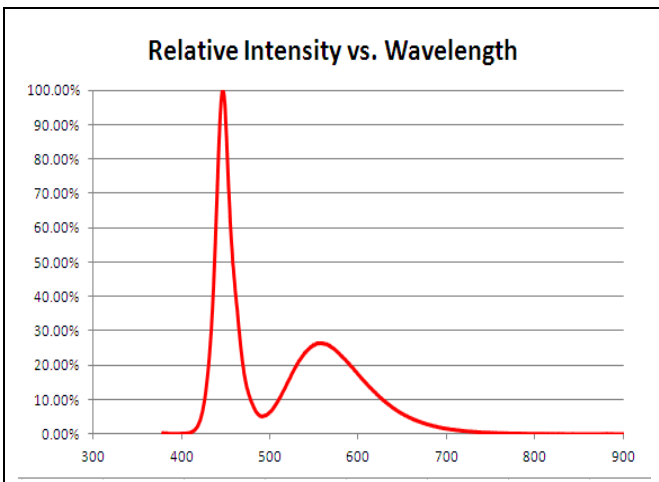

Official Product	HT Part No. F1071SP Series		
Tentative Product	*****	*****	
Specifications are subject to changes for improvement without advance notice. Proprietary data, drawings, company confidential all rights reserved.	10/16/2013	Version of 1.0	Page 11/18

Precaution for Use

1. The chips should not be used directly in any type of fluid such as water, oil, organic solvent, etc.
2. When the LEDs are illuminating, the maximum ambient temperature should be first considered before operation.
3. LEDs must be stored in a clean environment. A sealed container with a nitrogen atmosphere is necessary if the storage period is over 3 months after shipping.
4. The LEDs must be used within seven days after unpacked. Unused products must be repacked in an anti-electrostatic package, folded to close any opening and then stored in a dry and cool space.
5. The appearance and specifications of the products may be modified for improvement without further notice.
6. The LEDs are sensitive to the static electricity and surge. It is strongly recommended to use a grounded wrist band and anti-electrostatic glove when handling the LEDs. If a voltage over the absolute maximum rating is applied to LEDs, it will damage LEDs. Damaged LEDs will show some abnormal characteristics such as remarkable increase of leak current, lower turn-on voltage and getting unlit at low current.

Official Product	HT Part No. F1071SP Series		
Tentative Product	*****	*****	
Specifications are subject to changes for improvement without advance notice. Proprietary data, drawings, company confidential all rights reserved.	10/16/2013	Version of 1.0	Page 12/18

Packaging Tape Dimension

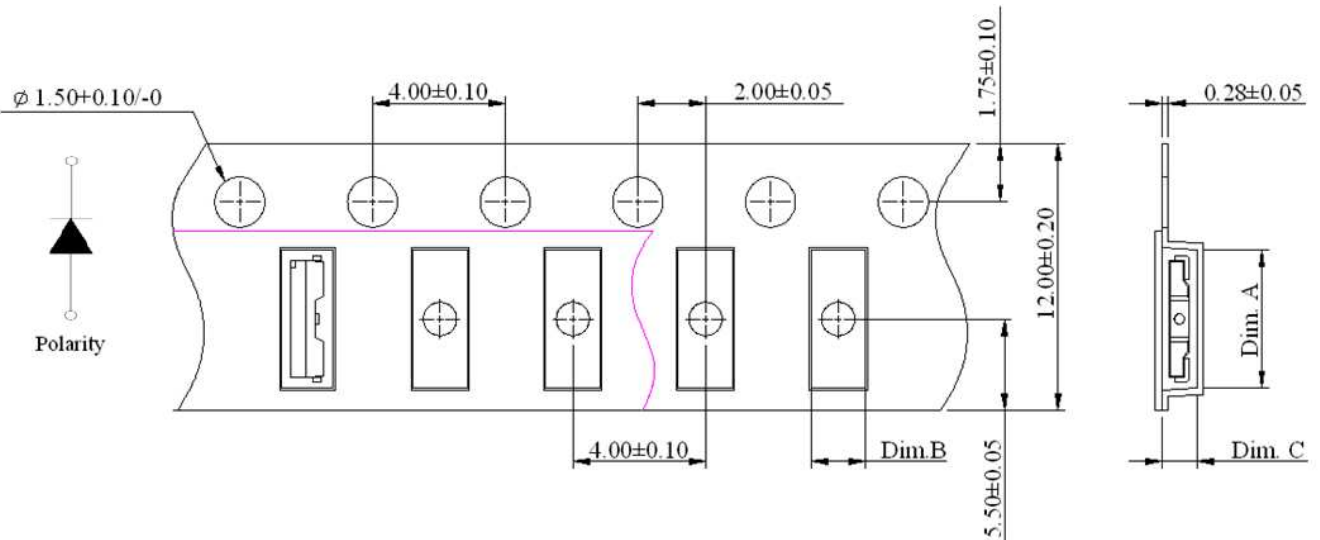

Dim. A	Dim. B	Dim. C	Q'ty/Reel
4.0 ± 0.10	1.35 ± 0.10	0.72 ± 0.10	2K

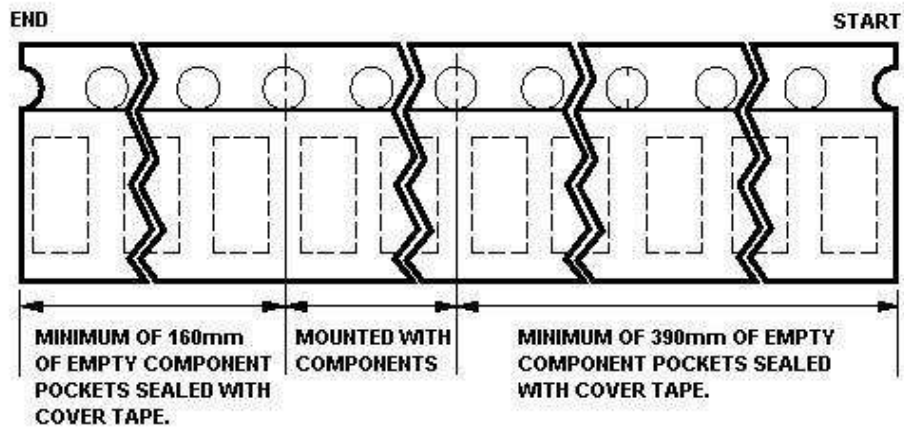

Official Product	HT Part No. F1071SP Series		
Tentative Product	*****	*****	
Specifications are subject to changes for improvement without advance notice. Proprietary data, drawings, company confidential all rights reserved.	10/16/2013	Version of 1.0	Page 13/18

Reel Dimension

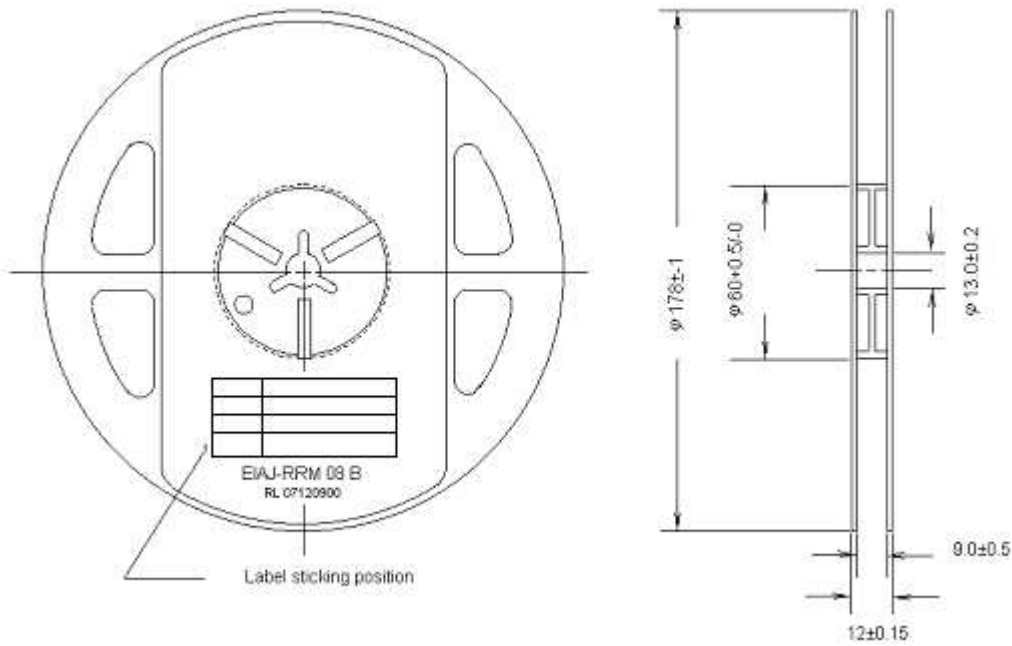

Packing

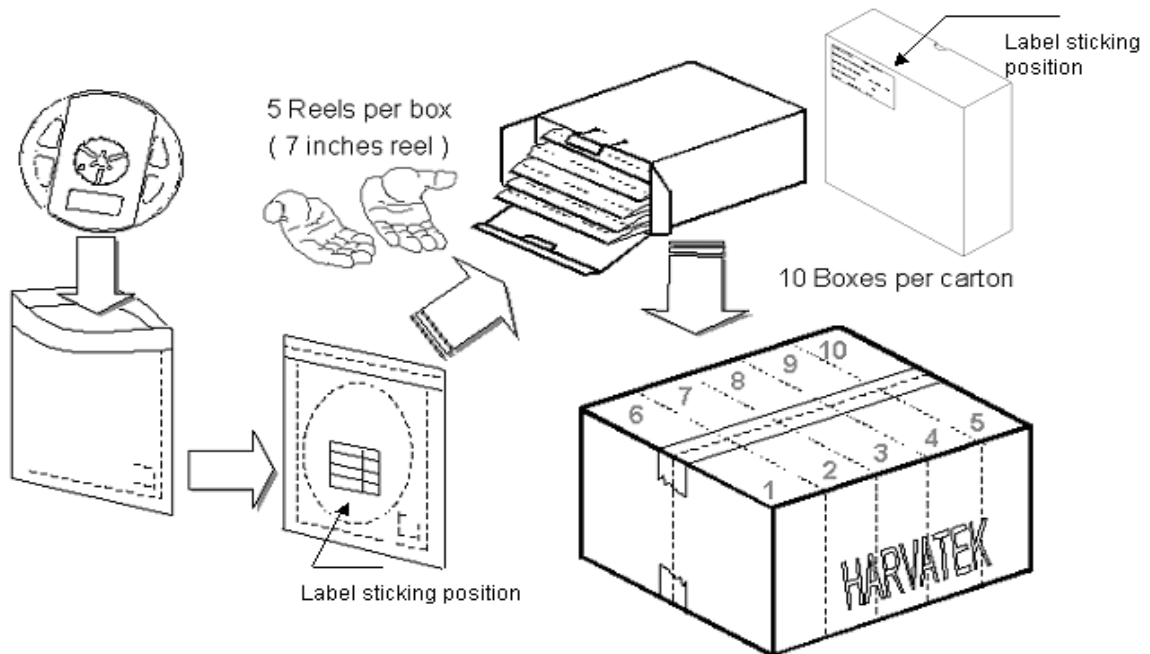

5 boxes per carton is available depending on shipment quantity.

Official Product	HT Part No. F1071SP Series		
Tentative Product	*****	*****	
Specifications are subject to changes for improvement without advance notice. Proprietary data, drawings, company confidential all rights reserved.	10/16/2013	Version of 1.0	Page 14/18

Dry Pack

All SMD optical devices are **MOISTURE SENSITIVE**. Avoid exposure to moisture at all times during transportation or storage. Every reel is packaged in a moisture protected anti-static bag. Each bag is properly sealed prior to shipment.

Upon request, a humidity indicator will be included in the moisture protected anti-static bag prior to shipment.

The packaging sequence is as follows:

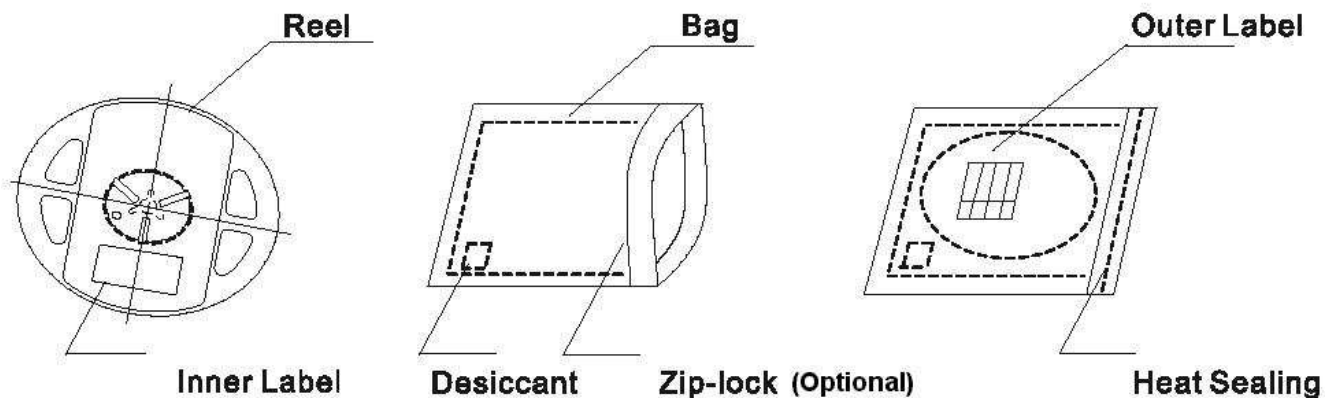

Baking

It's recommended to bake before soldering once the pack is unsealed open & re-sealed after 72 hours. The conditions are as followings:

1. $60 \pm 3^{\circ}\text{C} \times (12 \sim 24\text{hrs})$ and $< 5\% \text{ RH}$, taped reel type
2. $100 \pm 3^{\circ}\text{C} \times (45\text{min} \sim 1\text{hr})$, bulk type
3. $130 \pm 3^{\circ}\text{C} \times (15 \sim 30\text{min})$, bulk type

Precautions

1. Avoid exposure to moisture at all times during transportation or storage.
2. Anti-Static precaution must be taken when handling GaN, InGaN, and AlInGaP products.
3. It is suggested to connect the unit with a current limiting resistor of the proper size. Avoid applying a reverse voltage beyond the specified limit.
4. Avoid operation beyond the limits as specified by the absolute maximum ratings.
5. Avoid direct contact with the surface through which the LED emits light.
6. If possible, assemble the unit in a clean room or dust-free environment.

Official Product	HT Part No. F1071SP Series		
Tentative Product	*****	*****	
Specifications are subject to changes for improvement without advance notice. Proprietary data, drawings, company confidential all rights reserved.	10/16/2013	Version of 1.0	Page 15/18

Handling of Silicone Resin LEDs

Handling Indications

During processing, mechanical stress on the surface should be minimized as much as possible. Sharp objects of all types should not be used to pierce the sealing compound.

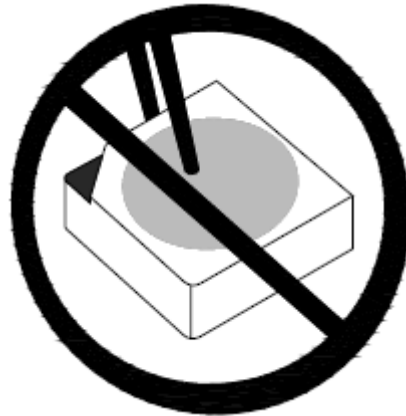

Figure 1

In general, LEDs should only be handled from the side. By the way, this also applies to LEDs without a silicone sealant, since the surface can also become scratched.

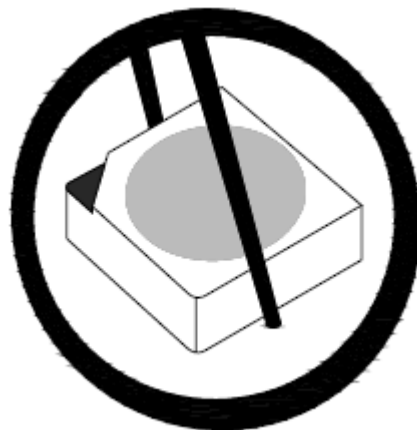

Figure 2

When populating boards in SMT production, there are basically no restrictions regarding the form of the pick and place nozzle, except that mechanical pressure on the surface of the resin must be prevented.

This is assured by choosing a pick and place nozzle which is large than LEDs reflector area.

Official Product	HT Part No. F1071SP Series		
Tentative Product	*****	*****	
Specifications are subject to changes for improvement without advance notice. Proprietary data, drawings, company confidential all rights reserved.	10/16/2013	Version of 1.0	Page 16/18

Reflow Soldering

Recommend soldering paste specifications:

1. Operating temp.: Above 220 °C ,60sec
2. Peak temp.:260 °CMax.,10sec Max.
3. Reflow soldering should not be done more than two times.
4. Never take next process until the component is cooled down to room temperature after reflow.
5. The recommended reflow soldering profile (measuring on the surface of the LED terminal) is following:

Lead-free Solder Profile

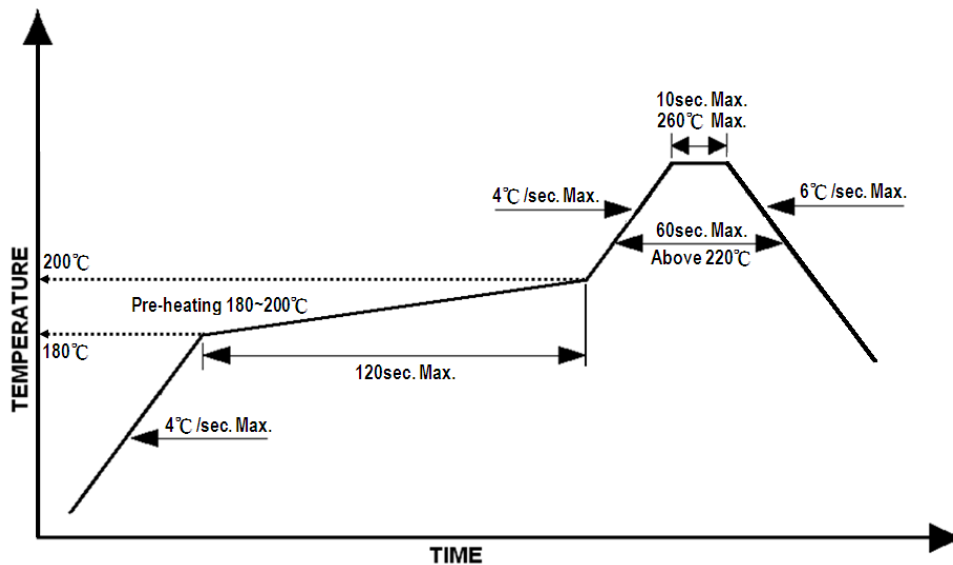

Reworking

- Rework should be completed within 5 seconds under 260 °C.
- The iron tip must not come in contact with the copper foil.
- Twin-head type is preferred.

Cleaning

Following are cleaning procedures after soldering:

- An alcohol-based solvent such as isopropyl alcohol (IPA) is recommended.
- Temperature x Time should be 50°C x 30sec. or <30°C x 3min
- Ultrasonic cleaning: < 15W/ bath; bath volume ≤ 1liter
- Curing: 100 °C max, <3min

Official Product	HT Part No. F1071SP Series		
Tentative Product	*****	*****	
Specifications are subject to changes for improvement without advance notice. Proprietary data, drawings, company confidential all rights reserved.	10/16/2013	Version of 1.0	Page 17/18

