

Harvatek COM LEDs Approval Sheet
Model No.: HT71 Series

Official Product	HT Part No. HT71	Your Part No.		Data Sheet No.
Tentative Product	*****	*****		
Specifications are subject to changes for improvement without advance notice. Proprietary data, drawings, company confidential all rights reserved.		Nov.-06, 2013	Version of 1.0	Page1/17

HARVATEK[®] COM- HT71C¹ Series

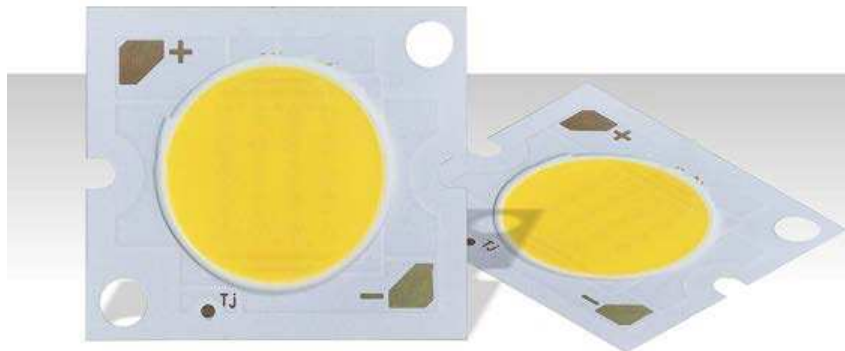

- Dimension : 22.8×25.8mm
- Typical Im : CW 1175 lm
WW 1030 lm@175mA
- Color Temperature : CW/ WW
- CRI : CW>78 WW>80 R9>0
- Assembly : Screws or thermal
conductive double-sided tape

Table of Contents

Dimensions 3

Absolute Maximum Ratings..... 4

Forward Voltage Characteristics 5

Operating Current and Luminous Flux Characteristics 6

Note:

The fifth code represents color temperature

1. C represents Cool White, it can be replaced by Letter N: Neutral White Letter W: Warm White.

Same as below shown.

Official Product	HT Part No. HT71	Your Part No.		Data Sheet No.
Tentative Product	*****	*****		
Specifications are subject to changes for improvement without advance notice. Proprietary data, drawings, company confidential all rights reserved.		Nov.-06, 2013	Version of 1.0	Page2/17

Dimensions

HT71

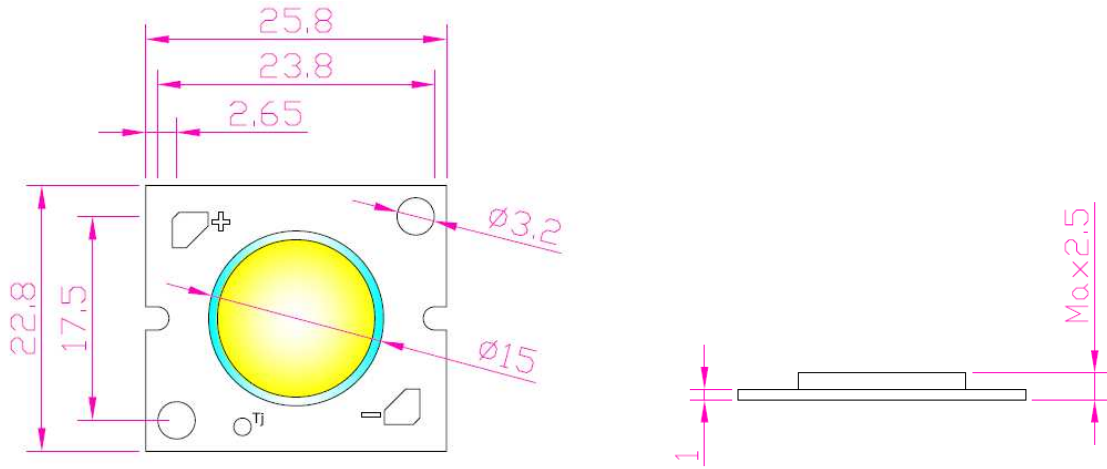

Top View

Front View

<Figure1 Drawing for part no. HT71C, HT71N, HT71W>.

Notes:

1. Solder pads are labeled “+” and “-” to denote positive and negative, respectively.
2. Drawings are not to scale.
3. Drawing dimensions are in millimeters.
4. Unless otherwise specified, tolerances are ± 0.20 mm.
5. The optical center of the LED Array is defined by the mechanical center of the array.

Official Product	HT Part No. HT71	Your Part No.		Data Sheet No.
Tentative Product	*****	*****		
Specifications are subject to changes for improvement without advance notice. Proprietary data, drawings, company confidential all rights reserved.		Nov.-06, 2013	Version of 1.0	Page3/17

Circuit Layout

HT71

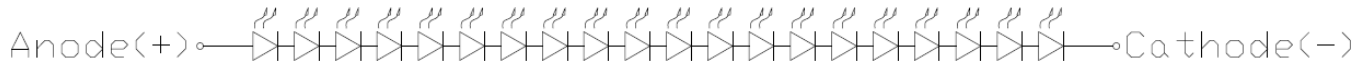

20S

Absolute Maximum Ratings

The following tables describe absolute maximum ratings of HT39 Series. Please refer to circuit layout on previous page for DC forward current & voltage selection.

Table 1-1

Parameter	Range	Unit	Symbol
LED Junction Temperature	<85	°C	T _j
Operating Temperature	(-40 to +100)	°C	
Storage Temperature	(-40 to +120)	°C	
LED Substrate Temperature(Heatsink)	<80	°C	T _s

Table 1-2

Parameter	Product Code		Unit	Symbol
	HT71 (20S)			
DC Forward Current ⁽¹⁾	175		mA	I _F
DC Forward Voltage	64.5		V	V _F
Reverse Voltage ⁽²⁾	--		V	V _R

Notes for Table1-2:

1. DC forward current should not exceed LED's operating current.
2. LEDs are not designed to be driven in reverse bias.

Official Product	HT Part No. HT71	Your Part No.		Data Sheet No.
Tentative Product	*****	*****		
Specifications are subject to changes for improvement without advance notice. Proprietary data, drawings, company confidential all rights reserved.		Nov.-06, 2013	Version of 1.0	Page4/17

Forward Voltage Characteristics

The following table describes forward voltage of HT71 Series. Please note that the all forward voltage range is based on constant driving current. Do not base on the values below to design a constant voltage system.

Table 2

P/N	Min. Voltage (V _F)	Typ. Voltage (V _F)	Max. Voltage (V _F)	Unit
HT71	59	64.5	68	V

Notes for Table 2:

Forward voltage is measured with an accuracy of ±10%

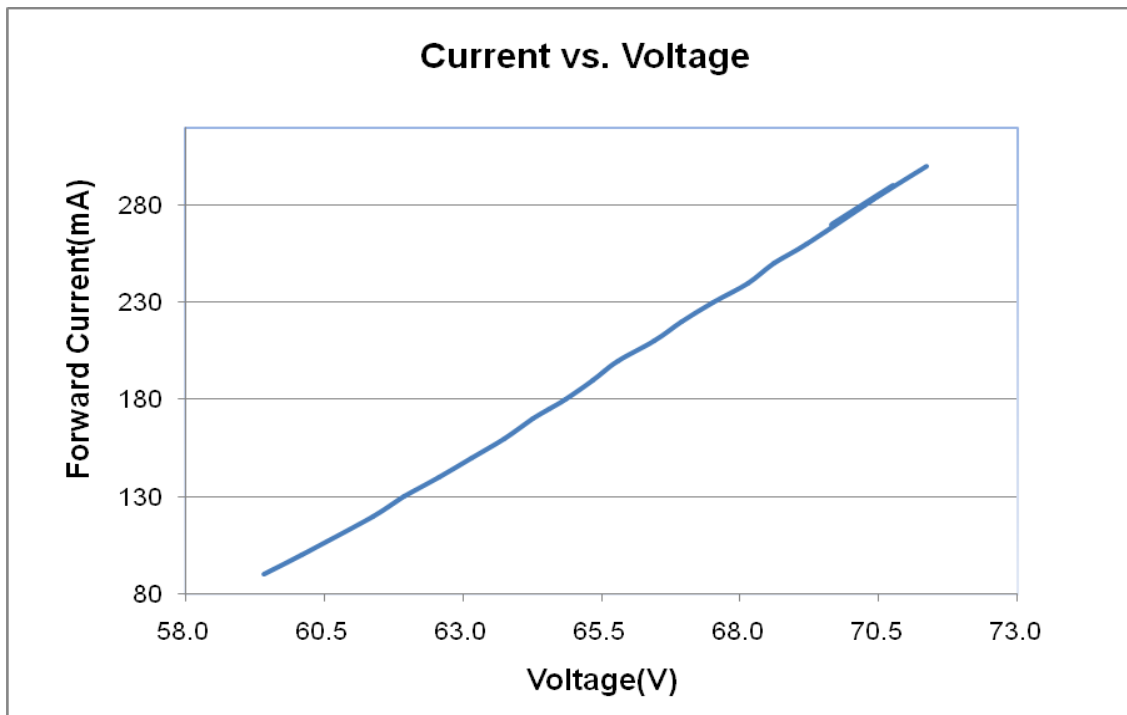

Official Product	HT Part No. HT71	Your Part No.		Data Sheet No.
Tentative Product	*****	*****		
Specifications are subject to changes for improvement without advance notice. Proprietary data, drawings, company confidential all rights reserved.		Nov.-06, 2013	Version of 1.0	Page5/17

Operating Current and Luminous Flux Characteristics

The following table describes typical luminous flux at $T_j=25^\circ\text{C}$ and $T_j=85^\circ\text{C}$ for HT39 at DC forward current 100mA, 150mA, 175mA and 250 mA.

The CCT range shown in the following table is COM Product standard CCT ranks.

Table 3

Product No.	ANSI CCT (K)	CRI	Luminous flux(lm)		Test Current (mA)	Power (W) (Typ)	Efficacy (lm/W) (Typ) at Tj 25°C)	Lumen depreciation
			Tj=25°C	Tj=85°C				
HT71C	5200K	>78	737	649	100	6.14	120	12%
			1045	920	150	9.59	109	12%
			1175	1034	175	11.41	104	12%
			1520	1338	250	17.25	88	12%
HT71N	4000K	>78	669	595	100	6.14	109	11%
			940	837	150	9.59	98	11%
			1095	975	175	11.41	96	11%
			1535	1366	250	17.25	89	11%
HT71W	2900K	>80	645	574	100	6.14	105	11%
			911	811	150	9.59	95	11%
			1030	917	175	11.41	91	11%
			1328	1182	250	17.25	77	11%

Notes for Table 3:

Luminous flux is measured with an accuracy of $\pm 10\%$

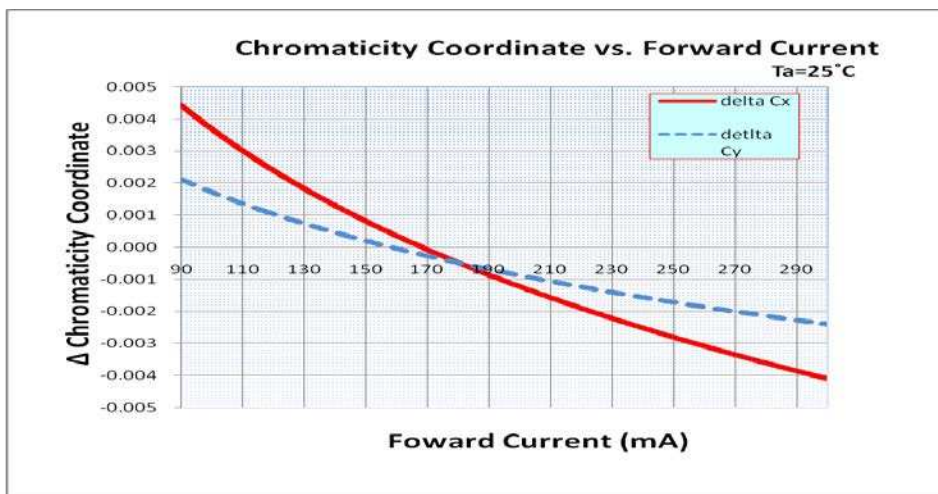

Official Product	HT Part No. HT71	Your Part No.	Data Sheet No.
Tentative Product	*****	*****	
Specifications are subject to changes for improvement without advance notice. Proprietary data, drawings, company confidential all rights reserved.		Nov.-06, 2013	Version of 1.0
			Page6/17

Current vs. Efficiency

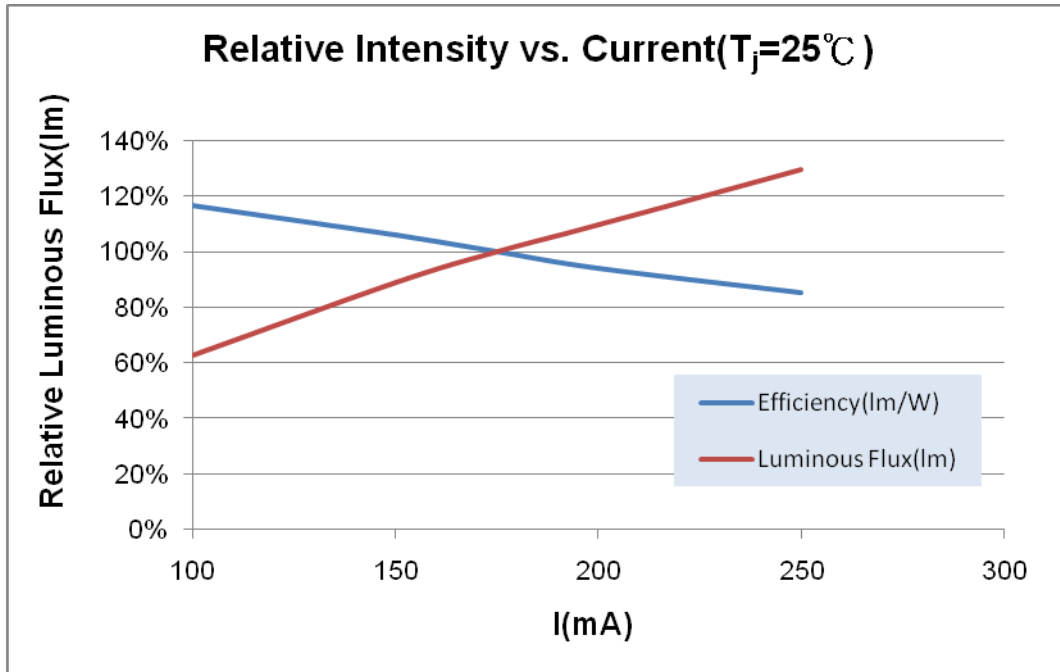

<Figure 2 The trend chart for relative intensity vs. current of HT71C, HT71W>

Input Current (mA)	100	150	175	250
Actual Watt	6.14	9.59	11.4	17.25
Total Typical Im for CW	737	1045	1175	1520
Total Typical Im for WW	645	911	1030	1328
Suggested Application	Bulb			

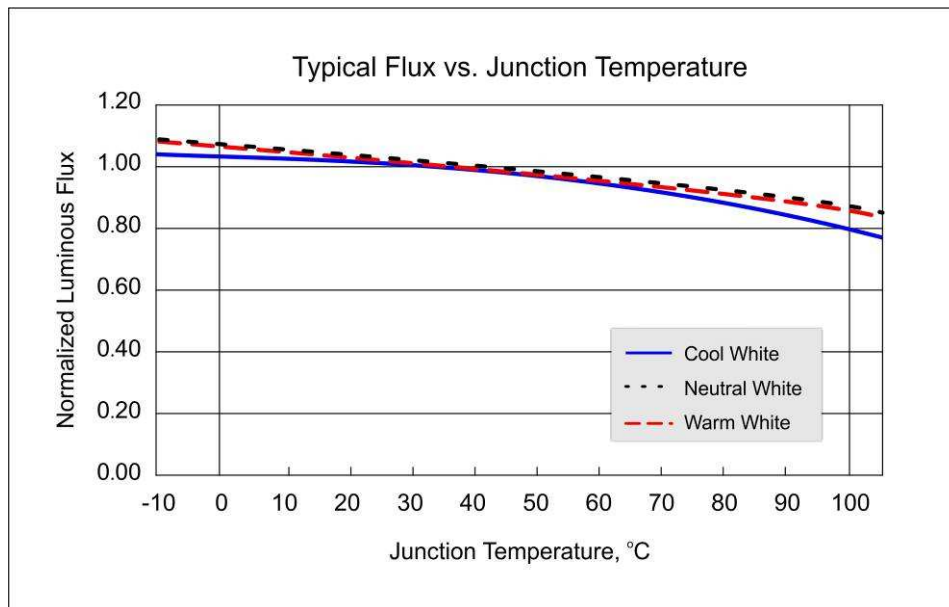

Official Product	HT Part No. HT71	Your Part No.		Data Sheet No.
Tentative Product	*****	*****		
Specifications are subject to changes for improvement without advance notice. Proprietary data, drawings, company confidential all rights reserved.		Nov.-06, 2013	Version of 1.0	Page7/17

Photometric

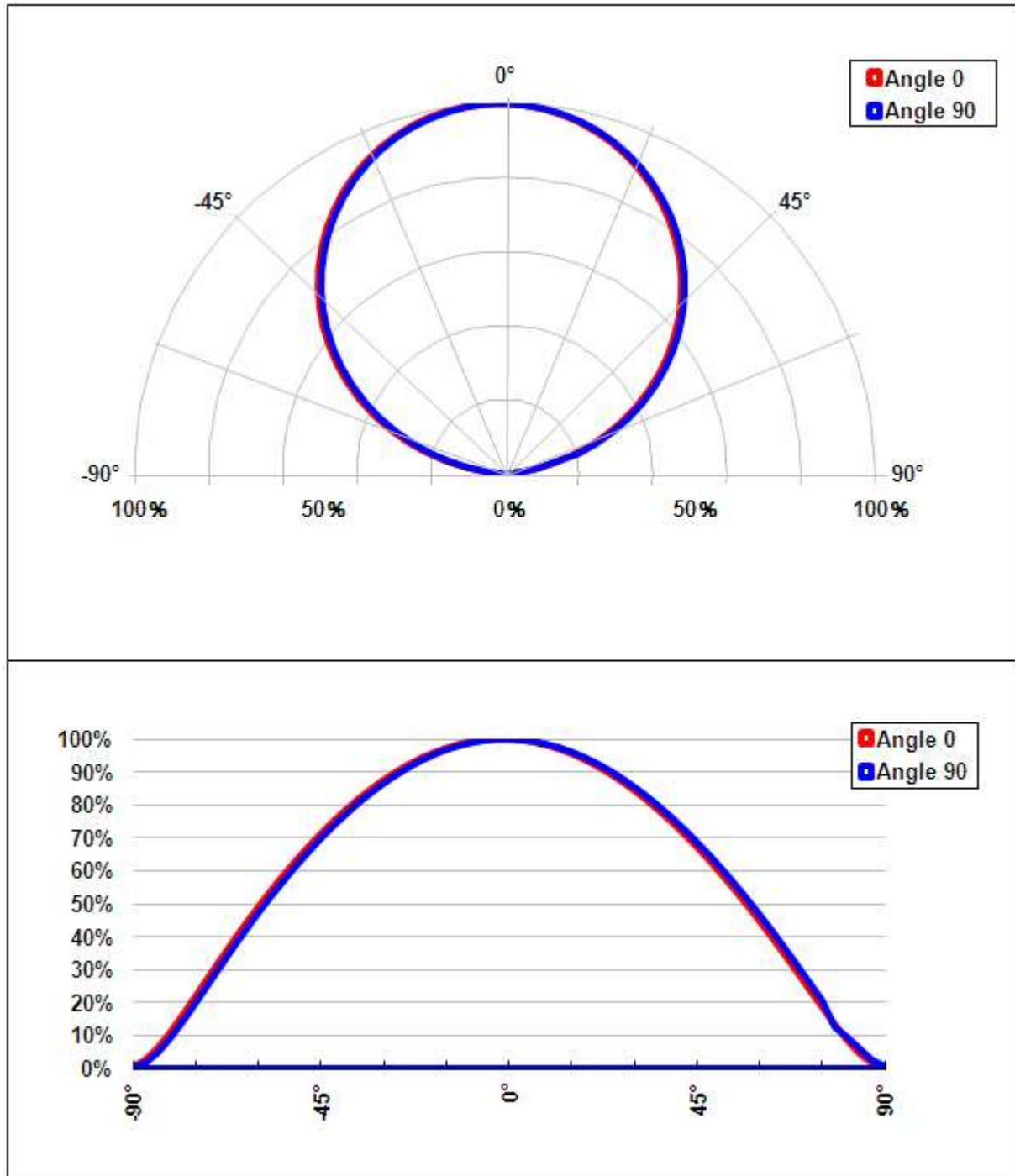

Official Product	HT Part No. HT71	Your Part No.		Data Sheet No.
Tentative Product	*****	*****		
Specifications are subject to changes for improvement without advance notice. Proprietary data, drawings, company confidential all rights reserved.		Nov.-06, 2013	Version of 1.0	Page8/17

Appendix

Official Product	HT Part No. HT71	Your Part No.		Data Sheet No.
Tentative Product	*****	*****		
Specifications are subject to changes for improvement without advance notice. Proprietary data, drawings, company confidential all rights reserved.		Nov.-06, 2013	Version of 1.0	Page9/17

BIN Code Definition

The following tables describe luminous flux group and color group.

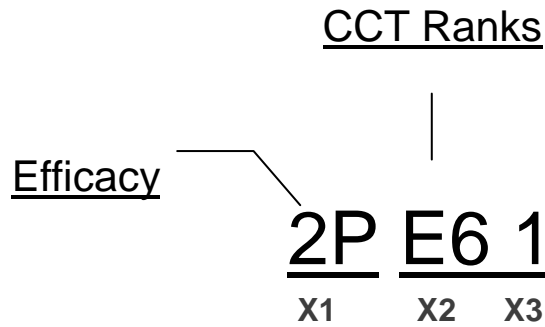

Table 1-1.

X1	X2	X3
Light Efficacy	ANSI C78.377A CCT Quadrangles	Detailed CCT Ranks
	E1 E10	0 No Detailed ranks
	E2 E20	1
	E3 E30	2
	E4 E40	3
	E5 E50	4
	E6 E60	
	E7 E70	
	E8 E80	

Official Product	HT Part No. HT71	Your Part No.		Data Sheet No.
Tentative Product	*****	*****		
Specifications are subject to changes for improvement without advance notice. Proprietary data, drawings, company confidential all rights reserved.		Nov.-06, 2013	Version of 1.0	Page10/17

Table 1-2. Light efficacy

Main BIN No.	lm/W		Secondary BIN No.	lm/W		Warm White (WW)			Neutral White (NW)		Cool White (CW)		
	min.	max.		min.	max.	E10	E20	E30	E40	E50	E60	E70	E80
						2700K	3000K	3500K	4000K	4500K	5000K	5700K	6500K
J	10	25	1J	10	17								
			2J	17	25								
K	25	40	1K	25	32								
			2K	32	40								
L	40	62	1L	40	51								
			2L	51	62								
M	62	70	1M	62	66								
			2M	66	70								
N	70	85	1N	70	77		Main						
			2N	77	85		Main		Main				
P	85	100	1P	85	92		Main		Main				
			2P	92	100		Main		Main		Main		
Q	100	115	1Q	100	107				Main		Main		
			2Q	107	115						Main		
R	115	130	1R	115	122						Main		
			2R	122	130								
S	130	145	1S	130	137								
			2S	137	145								
T	145	160	1T	145	152								
			2T	152	160								
U	160	175	1U	160	167								
			2U	167	175								
V	175	190	1V	175	182								
			2V	182	190								
W	190	205	1W	190	197								
			2W	197	205								

Official Product	HT Part No. HT71	Your Part No.	Data Sheet No.
Tentative Product	*****	*****	
Specifications are subject to changes for improvement without advance notice. Proprietary data, drawings, company confidential all rights reserved.		Nov.-06, 2013	Version of 1.0
			Page11/17

Table 1-3. CCT ANSI C78.377A

BIN Code		E10	E20	E30	E40	E50	E60	E70	E80
Nominal CCT(K)		2700	3000	3500	4000	4500	5000	5700	6500
CCT Range(K)		2580-2870	2870-3220	3220-3710	3710-4260	4260-4745	4745-5310	5310-6020	6020-7040
Center	x	0.4578	0.4338	0.4073	0.3818	0.3611	0.3447	0.3287	0.3123
	y	0.4101	0.4030	0.3917	0.3797	0.3658	0.3553	0.3417	0.3282
Tolerance Quadrant	x	0.4813	0.4562	0.4299	0.4006	0.3736	0.3551	0.3376	0.3205
	y	0.4319	0.4260	0.4165	0.4044	0.3874	0.3760	0.3616	0.3481
	x	0.4562	0.4299	0.3996	0.3736	0.3548	0.3376	0.3207	0.3028
	y	0.4260	0.4165	0.4015	0.3874	0.3736	0.3616	0.3462	0.3304
	x	0.4373	0.4147	0.3889	0.3670	0.3512	0.3366	0.3222	0.3068
	y	0.3893	0.3814	0.3690	0.3578	0.3465	0.3369	0.3234	0.3113
	x	0.4593	0.4373	0.4147	0.3898	0.3670	0.3515	0.3366	0.3221
	y	0.3944	0.3893	0.3814	0.3716	0.3578	0.3487	0.3369	0.3261

Table 1-4. Secondary BIN No.

BIN Code	Secondary BIN No.	Position	CCT(K)		Tolerance Quadrant							
			Left	Right	Right Up		Left Up		Left Down		Right Down	
			min.	max.	x	y	x	y	x	y	x	y
E10	E11	Down	2580	2725	0.4703	0.4132	0.4593	0.4106	0.4483	0.3919	0.4593	0.3944
	E12	Up			0.4813	0.4319	0.4688	0.4290	0.4593	0.4106	0.4703	0.4132
	E13	Down	2725	2870	0.4593	0.4106	0.4468	0.4077	0.4373	0.3893	0.4483	0.3919
	E14	Up			0.4688	0.4290	0.4562	0.4260	0.4468	0.4077	0.4593	0.4106
E20	E21	Down	2870	3045	0.4468	0.4077	0.4355	0.4037	0.4260	0.3854	0.4373	0.3893
	E22	Up			0.4562	0.4260	0.4431	0.4213	0.4355	0.4037	0.4468	0.4077
	E23	Down	3045	3220	0.4355	0.4037	0.4223	0.3990	0.4147	0.3814	0.4260	0.3854
	E24	Up			0.4431	0.4213	0.4299	0.4165	0.4223	0.3990	0.4355	0.4037
E30	E31	Down	3220	3465	0.4223	0.3990	0.4094	0.3928	0.4018	0.3752	0.4147	0.3814
	E32	Up			0.4299	0.4165	0.4148	0.4090	0.4094	0.3928	0.4223	0.3990
	E33	Down	3465	3710	0.4094	0.3928	0.3943	0.3853	0.3889	0.3690	0.4018	0.3752
	E34	Up			0.4148	0.4090	0.3996	0.4015	0.3943	0.3853	0.4094	0.3928

Official Product	HT Part No. HT71	Your Part No.		Data Sheet No.
Tentative Product	*****	*****		
Specifications are subject to changes for improvement without advance notice. Proprietary data, drawings, company confidential all rights reserved.		Nov.-06, 2013	Version of 1.0	Page12/17

E40	E41	Down	3710	3985	0.3952	0.3880	0.3838	0.3811	0.3784	0.3647	0.3898	0.3716
	E42	Up			0.4006	0.4044	0.3871	0.3959	0.3838	0.3811	0.3952	0.3880
	E43	Down	3985	4260	0.3838	0.3811	0.3703	0.3726	0.3670	0.3578	0.3784	0.3647
	E44	Up			0.3871	0.3959	0.3736	0.3874	0.3703	0.3726	0.3838	0.3811
E50	E51	Down	4260	4502.5	0.3703	0.3726	0.3624	0.3670	0.3591	0.3522	0.3670	0.3578
	E52	Up			0.3736	0.3874	0.3642	0.3805	0.3624	0.3670	0.3703	0.3726
	E53	Down	4502.5	4745	0.3624	0.3670	0.3530	0.3601	0.3512	0.3465	0.3591	0.3522
	E54	Up			0.3642	0.3805	0.3548	0.3736	0.3530	0.3601	0.3624	0.3670
E60	E61	Down	4745	5027.5	0.3533	0.3624	0.3459	0.3565	0.3441	0.3428	0.3515	0.3487
	E62	Up			0.3551	0.3760	0.3464	0.3688	0.3459	0.3565	0.3533	0.3624
	E63	Down	5027.5	5310	0.3459	0.3565	0.3371	0.3493	0.3366	0.3369	0.3441	0.3428
	E64	Up			0.3464	0.3688	0.3376	0.3616	0.3371	0.3493	0.3459	0.3565
E70	E71	Down	5310	5665	0.3371	0.3493	0.3299	0.3425	0.3294	0.3302	0.3366	0.3369
	E72	Up			0.3376	0.3616	0.3292	0.3539	0.3299	0.3425	0.3371	0.3493
	E73	Down	5665	6020	0.3299	0.3425	0.3215	0.3348	0.3222	0.3234	0.3294	0.3302
	E74	Up			0.3292	0.3539	0.3207	0.3462	0.3215	0.3348	0.3299	0.3425
E80	E81	Down	6020	6530	0.3213	0.3371	0.3137	0.3297	0.3145	0.3187	0.3221	0.3261
	E82	Up			0.3205	0.3481	0.3117	0.3393	0.3137	0.3297	0.3213	0.3371
	E83	Down	6530	7040	0.3137	0.3297	0.3048	0.3209	0.3068	0.3113	0.3145	0.3187
	E84	Up			0.3117	0.3393	0.3028	0.3304	0.3048	0.3209	0.3137	0.3297

Official Product	HT Part No. HT71	Your Part No.		Data Sheet No.
Tentative Product	*****	*****		
Specifications are subject to changes for improvement without advance notice. Proprietary data, drawings, company confidential all rights reserved.		Nov.-06, 2013	Version of 1.0	Page13/17

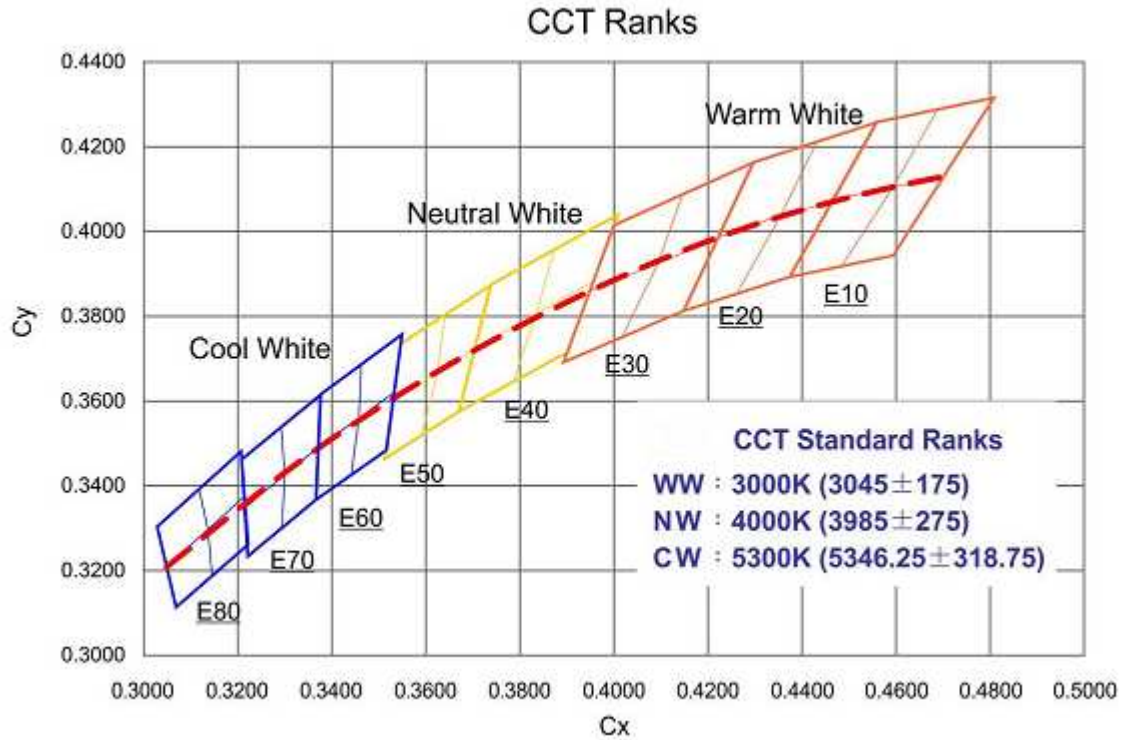

<Figure 1 CCT Ranks>

Color Temperature Characteristics

The following tables describe color temperature of HT71 series.

Table 2.

P/N	Color	λ_d / CCT		Unit
		Min.	Max	
HT71C	Cool White	5000	10000	K
HT71N	Neutral White	3700	5000	K
HT71W	Warm White	2600	3700	K

Notes for Table 2:

1. CCT is measured with an accuracy of $\pm 200K$.

Official Product	HT Part No. HT71	Your Part No.		Data Sheet No.
Tentative Product	*****	*****		
Specifications are subject to changes for improvement without advance notice. Proprietary data, drawings, company confidential all rights reserved.		Nov.-06, 2013	Version of 1.0	Page14/17

Color Spectrum

Cool White Color Spectrum

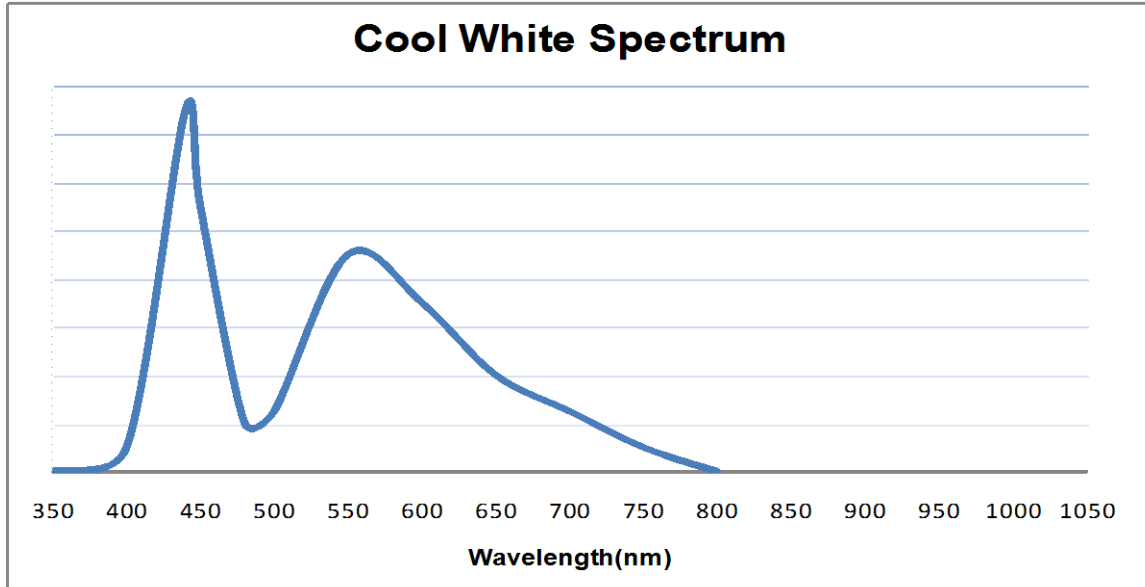

<Figure 2 cool white color spectrum of HT71 typical CCT part, integrated measurement>

Neutral White Color Spectrum

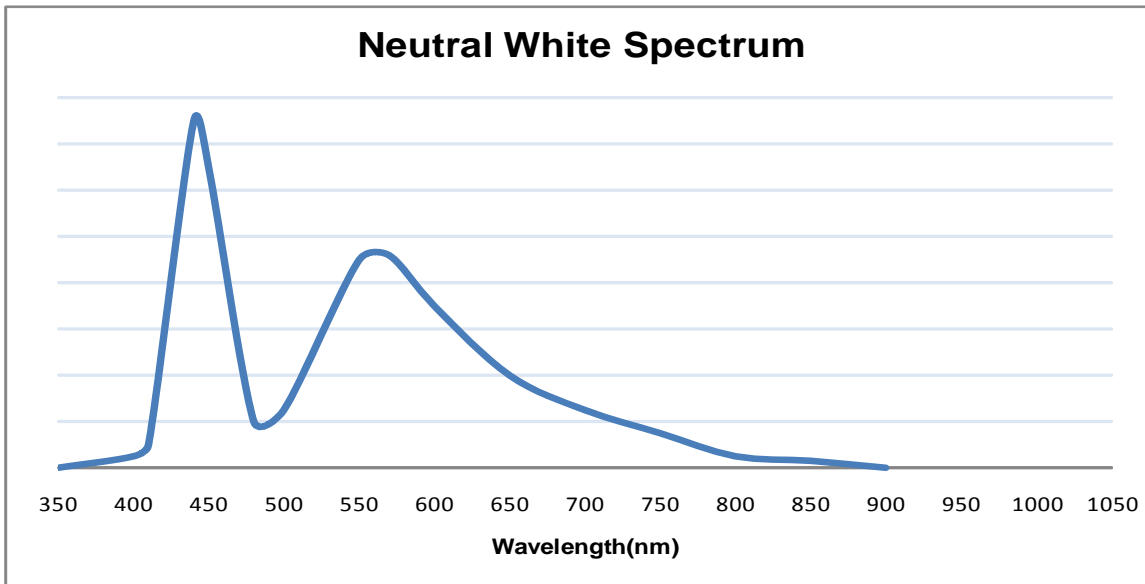

<Figure 3 neutral white color spectrum of HT71 typical CCT part, integrated measurement>

Official Product	HT Part No. HT71	Your Part No.		Data Sheet No.
Tentative Product	*****	*****		
Specifications are subject to changes for improvement without advance notice. Proprietary data, drawings, company confidential all rights reserved.		Nov.-06, 2013	Version of 1.0	Page15/17

Warm White Color Spectrum

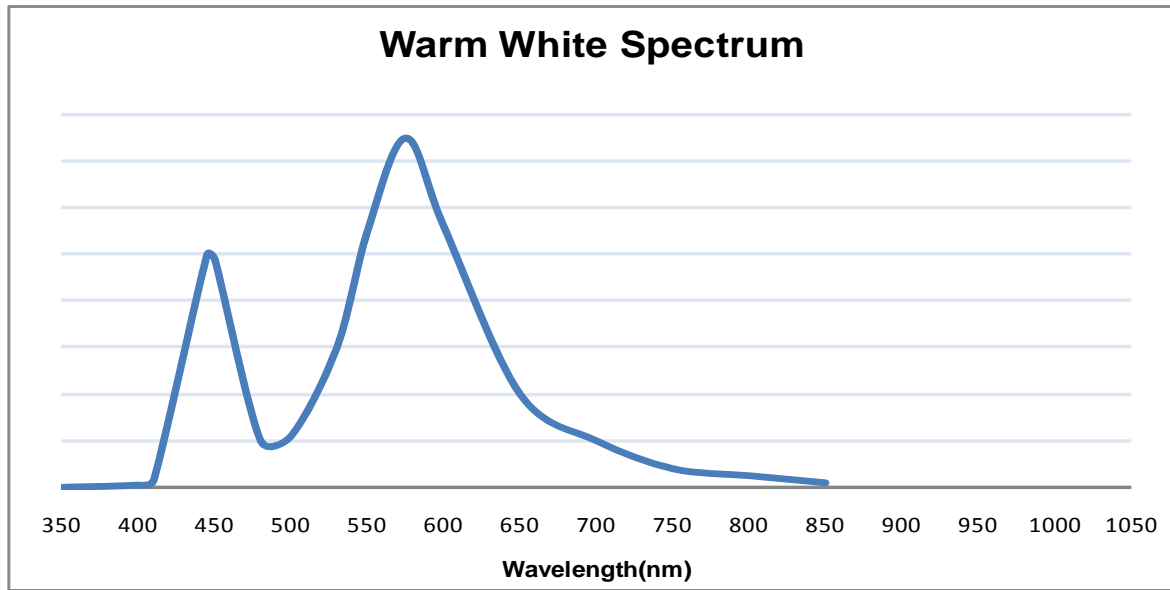

<Figure 4 warm white color spectrum of HT71 typical CCT part, integrated measurement>

Official Product	HT Part No. HT71	Your Part No.		Data Sheet No.
Tentative Product	*****	*****		
Specifications are subject to changes for improvement without advance notice. Proprietary data, drawings, company confidential all rights reserved.		Nov.-06, 2013	Version of 1.0	Page16/17

Precaution

- Don't touch, push or squish the light emitting area

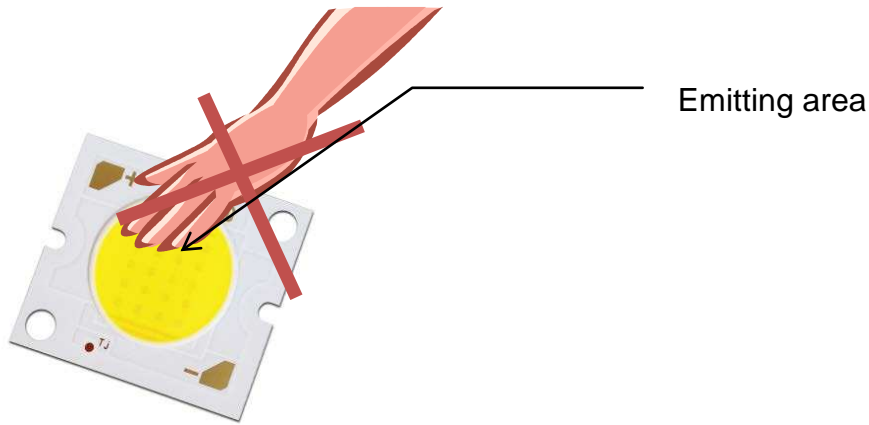

Do not touch the LED Array or resin area during operation. Allow the LED Array to cool for a sufficient period of time before handling. The LED Array may reach elevated temperatures such that it can burn skin when touched.

- Recommended soldering method

1	Please set up the temperature of the temperature-controlled solder to 400 °C when soldering.
2	Please put the emitter on hot plate and set up the temperature of the hot plate to 100°C±10°C. Besides, please set up the temperature of the temperature-controlled solder to 300°C±10°C.

Official Product	HT Part No. HT71	Your Part No.		Data Sheet No.
Tentative Product	*****	*****		
Specifications are subject to changes for improvement without advance notice. Proprietary data, drawings, company confidential all rights reserved.		Nov.-06, 2013	Version of 1.0	Page17/17