

## PTH05060 5 Vin

**Total Power:** 36 Watts  
**# of Outputs:** Single

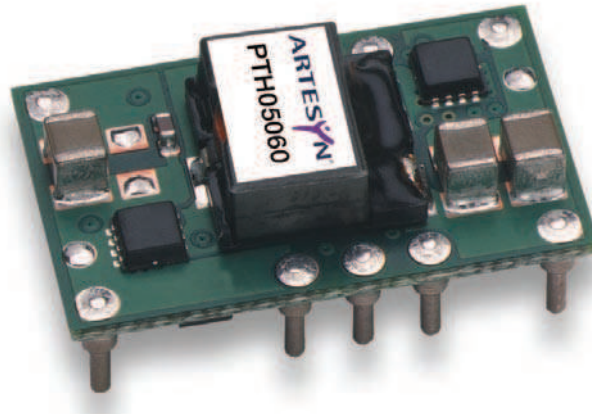

### Special Features

- 10 A output current
- 5 V input voltage
- Wide-output voltage adjust 0.8 Vdc to 3.6 Vdc
- Auto-track™ sequencing\*
- Margin up/down controls
- Pre-bias start-up capability
- Efficiencies up to 94%
- Output ON/OFF inhibit
- Output voltage sense
- Point-of-Load-Alliance (POLA) compatible
- Available RoHS compliant
- 2 Year Warranty

### Safety

- UL/cUL CAN/CSA-C22.2 No. 60950-1-03/UL 60950-1, File No. E174104
- TÜV Product Service (EN60950) Certificate No. B 04 06 38572 044
- CB Report and Certificate to IEC60950, Certificate No. US/8292/UL

## Specifications

Input		
Input voltage range:	(See Note 3, page 3)	4.5 - 5.5 Vdc
Input current:	No load	10 mA typ.
Remote ON/OFF:	(See Note 1, page 3)	Positive logic
Start-up time:		1 V/ms
Undervoltage lockout:		3.7 - 4.3 V typ.
Track input voltage:	Pin 8 (See Note 6 & 7, page 3)	± 0.3 Vin
Output		
Voltage adjustability:	(See Note 4, page 3)	0.8 - 3.6 Vdc
Setpoint accuracy:		± 2.0% Vo
Line regulation:		± 10 mV typ.
Load regulation:		± 12 mV typ.
Total regulation:		± 3.0% Vo
Minimum load:		0 A
Ripple and noise:	20 MHz bandwidth	25 mV pk-pk
Temperature co-efficient:	-40 °C to +85 °C	± 0.5% Vo
Transient response: (See Note 5, page 3)		70 μs recovery time Overshoot/undershoot 100 mV
Margin adjustment:		± 5.0% Vo

All specifications are typical at nominal input, full load at 25 °C unless otherwise stated  
C<sub>in</sub> = 330 μF, C<sub>out</sub> = 0 μF

\*Auto-track™ is a trade mark of Texas Instruments



## Specifications Continued

EMC Characteristics	
Electrostatic discharge:	EN61000-4-2, IEC801-2
Conducted immunity:	EN61000-4-6
Radiated immunity:	EN61000-4-3

General Specifications		
Efficiency:	See efficiency table on page 3	94% max
Insulation voltage:		Non-Isolated
Switching frequency:		300 kHz typ. ±25 kHz
Approvals and standards:		EN60950, UL/cUL60950
Material flammability:		UL94V-0
Dimensions:	(L x W x H)	25.27 x 15.75 x 9.00 mm 0.995 x 0.620 x 0.354 in
Weight:		3.7g (0.13 oz)
MTBF:	Telcordia SR-332	7,092,000 hours

## Environmental Specifications

Thermal performance: (See Note 2, page 3)	Operating ambient, temperature Non-operating	-40° C to +85 °C -40° C to +125 °C
MSL ('Z' suffix only):	JEDEC J-STD-020C	Level 3

Protection		
Short circuit:	Auto reset	20 A typ.

## Ordering Information

Output Power (max)	Input Voltage	Output Voltage	Output Currents		Efficiency (max)	Regulation		Model Numbers <sup>(9, 10)</sup>
			Min	Max		Line	Load	
36 W	4.5 - 5.5 Vdc	0.8 - 3.6 Vdc	0 A	10 A	94%	± 10 mV	± 12 mV	PTH05060

## Part Number System with Options

**PTH05060WAST**

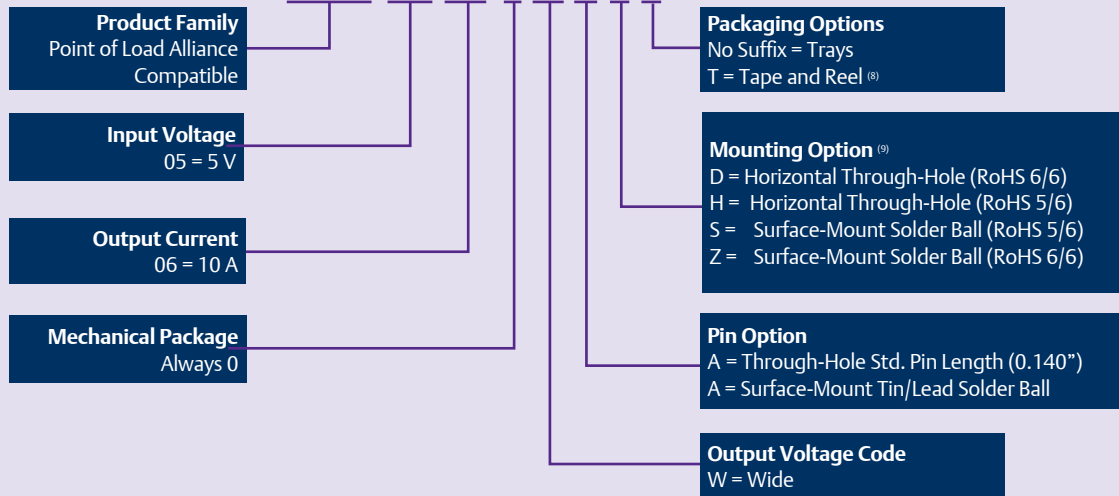

## Output Voltage Adjustment of the PTH05060 Series

The ultra-wide output voltage trim range offers major advantages to users who select the PTH05060. It is no longer necessary to purchase a variety of modules in order to cover different output voltages. The output voltage can be trimmed in a range of 0.8 Vdc to 3.6 Vdc. When the PTH05060 converter leaves the factory the output has been adjusted to the default voltage of 0.8 V.

Efficiency Table ( $I_O = 7\text{ A}$ )

Output Voltage	Efficiency
$V_O = 1.0\text{ V}$	85%
$V_O = 1.2\text{ V}$	86%
$V_O = 1.5\text{ V}$	89%
$V_O = 1.8\text{ V}$	90%
$V_O = 2.0\text{ V}$	91%
$V_O = 2.5\text{ V}$	92%
$V_O = 3.3\text{ V}$	94%

## Notes

- Remote ON/OFF. Positive Logic  
ON: Pin 3 open; or  $V > V_{in} - 0.5\text{ V}$   
OFF: Pin 3 GND; or  $V < 0.8\text{ V}$  (min - 0.2 V).
- See Figures 1 and 2 for safe operating curves.
- A 330  $\mu\text{F}$  electrolytic input capacitor is required for proper operation. The capacitor must be rated for a minimum of 500 mA rms of ripple current.
- An external output capacitor is not required for basic operation. Adding 330  $\mu\text{F}$  of distributed capacitance at the load will improve the transient response.
- 1 A/ $\mu\text{s}$  load step, 50 to 100%  $I_{Omax}$ ,  $C_{out} = 330\ \mu\text{F}$ .
- If utilized  $V_{out}$  will track applied voltage by  $\pm 0.3\text{ V}$  (up to  $V_O$  set point).
- The pre-bias start-up feature is not compatible with Auto-Track™. This is because when the module is under Auto-Track™ control, it is fully active and will sink current if the output voltage is below that of a back-feeding source. Therefore to ensure a pre-bias hold-off, one of the following two techniques must be followed when input power is first applied to the module. The Auto-Track™ function must either be disabled, or the module's output held off using the inhibit pin. Refer to Application Note 159 for more details.
- Tape and reel packaging only available on the surface-mount versions.
- To order Pb-free (RoHS compatible) surface-mount parts replace the mounting option 'S' with 'Z', e.g. PTH05060WAZ. To order Pb-free (RoHS compatible) through-hole parts replace the mounting option 'H' with 'D', e.g. PTH05060WAD.
- NOTICE: Some models do not support all options. Please contact your local Emerson Network Power representative or use the on-line model number search tool at <http://www.PowerConversion.com> to find a suitable alternative.

## Characteristic Data

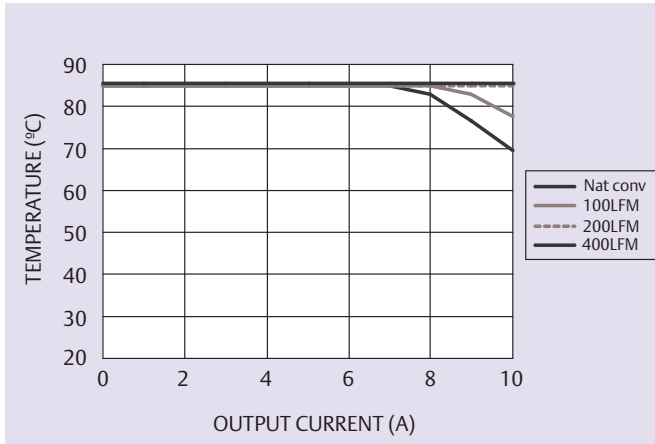

**Figure 1 - Safe Operating Area**  
Vin = 5 V, Output Voltage = 3.3 V (See Note A)

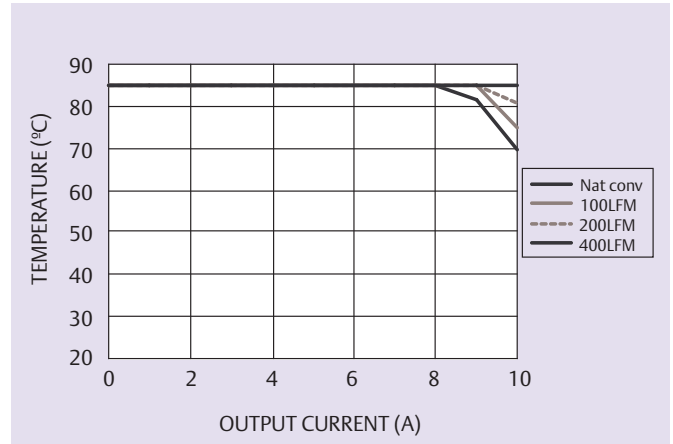

**Figure 2 - Safe Operating Area**  
Vin = 5 V, Output Voltage = 1.0 V (See Note A)

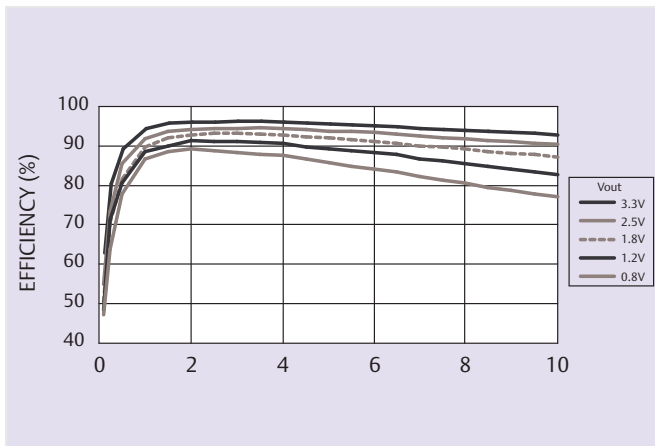

**Figure 3 - Efficiency vs Load Current**  
Vin = 5 V (See Note B)

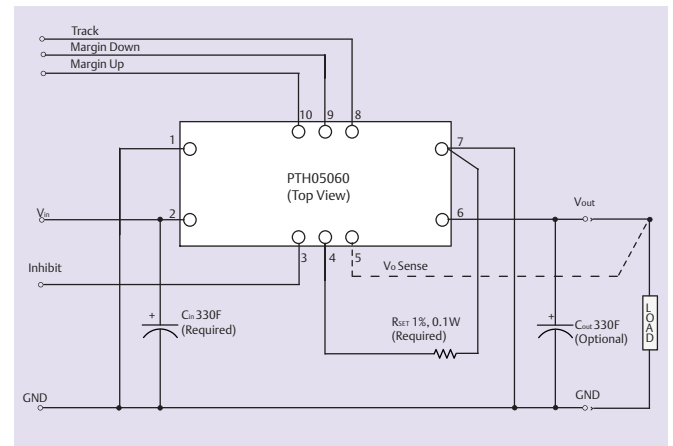

**Figure 4 - Standard Application**

### Notes

- A SOA curves represent the conditions at which internal components are within the Emerson Network Power derating guidelines.
- B Characteristic data has been developed from actual products tested at 25 °C. This data is considered typical data for the converter.

## Mechanical Drawings

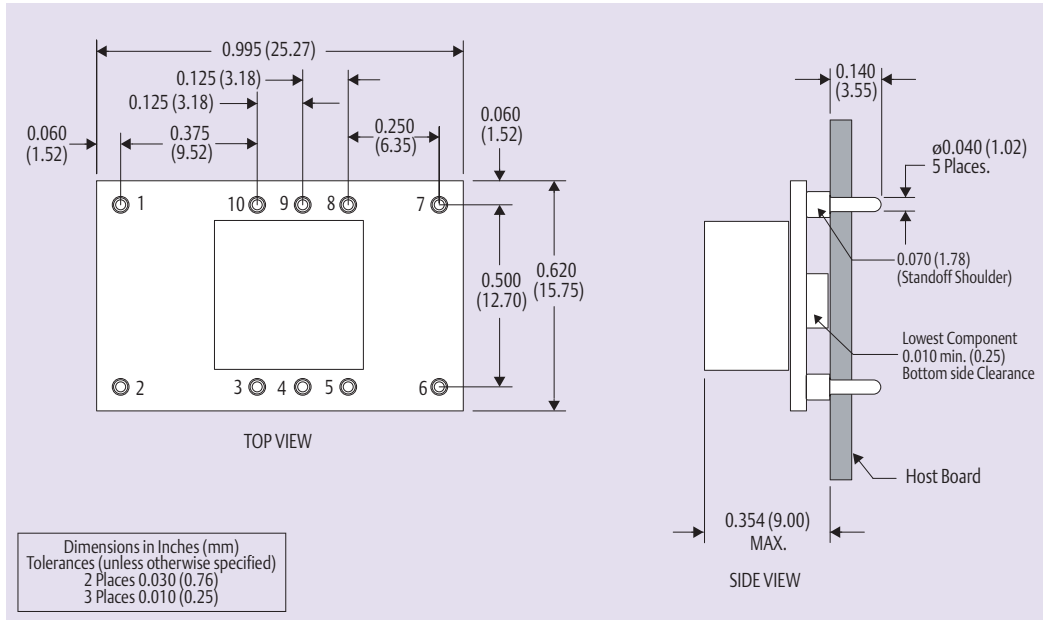

Figure 5 - Plated Through-Hole

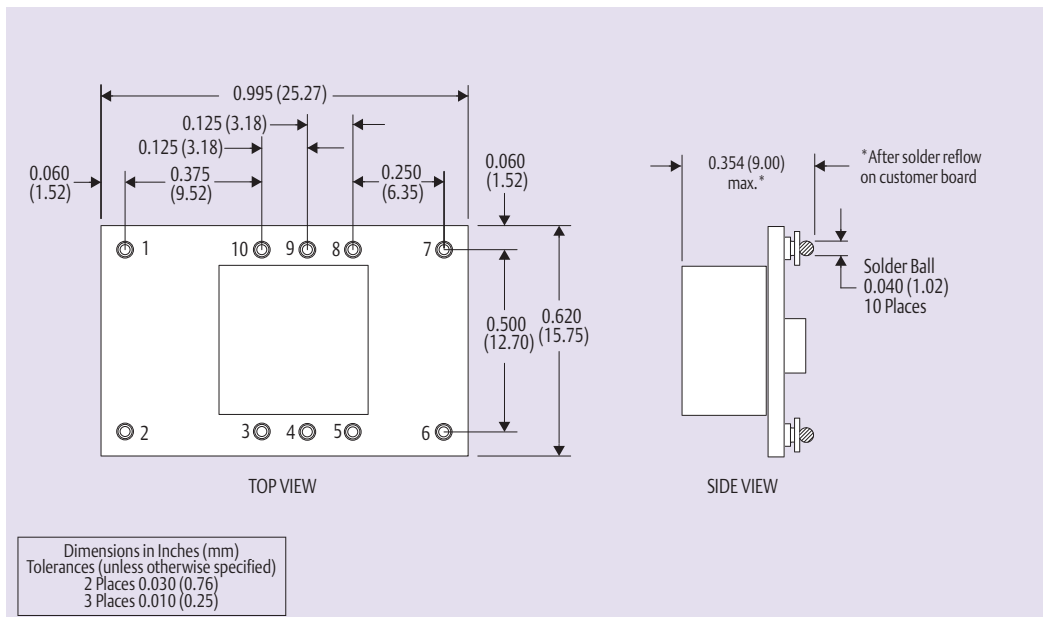

Figure 6 - Surface-Mount

Pin Connections	
Pin No.	Function
Pin 1	Ground
Pin 2	Vin
Pin 3	Inhibit*
Pin 4	Vo adjust
Pin 5	Vo sense

Pin Connections cont.	
Pin No.	Function
Pin 6	Vout
Pin 7	Ground
Pin 8	Track
Pin 9	Margin down*
Pin 10	Margin up*

\* Denotes negative logic:  
Open = Normal operation  
Ground = Function active

### Americas

5810 Van Allen Way  
Carlsbad, CA 92008  
USA  
Telephone: +1 760 930 4600  
Facsimile: +1 760 930 0698

### Europe (UK)

Waterfront Business Park  
Merry Hill, Dudley  
West Midlands, DY5 1LX  
United Kingdom  
Telephone: +44 (0) 1384 842 211  
Facsimile: +44 (0) 1384 843 355

### Asia (HK)

14/F, Lu Plaza  
2 Wing Yip Street  
Kwun Tong, Kowloon  
Hong Kong  
Telephone: +852 2176 3333  
Facsimile: +852 2176 3888

For global contact, visit:

[www.PowerConversion.com](http://www.PowerConversion.com)  
[techsupport.embeddedpower@emerson.com](mailto:techsupport.embeddedpower@emerson.com)

While every precaution has been taken to ensure accuracy and completeness in this literature, Emerson Network Power assumes no responsibility, and disclaims all liability for damages resulting from use of this information or for any errors or omissions.

**Emerson Network Power.**  
The global leader in enabling  
business-critical continuity.

- AC Power
- Connectivity
- DC Power
- Embedded Computing
- Embedded Power**
- Monitoring
- Outside Plant
- Power Switching & Controls
- Precision Cooling
- Racks & Integrated Cabinets
- Services
- Surge Protection

[EmersonNetworkPower.com](http://EmersonNetworkPower.com)

Emerson Network Power and the Emerson Network Power logo are trademarks and service marks of Emerson Electric Co. ©2008 Emerson Electric Co.