

# HER801 THRU HER806



8.0 AMP HIGH EFFICIENCY RECTIFIERS



## FEATURES

- \* Low forward voltage drop
- \* High current capability
- \* High reliability
- \* High surge current capability
- \* High speed switching

## MECHANICAL DATA

- \* Case: Molded plastic
- \* Epoxy: UL 94V-0 rate flame retardant
- \* Lead: Lead solderable per MIL-STD-202, method 208 guaranteed
- \* Polarity: As Marked
- \* Mounting position: Any
- \* Weight: 2.24 grams

## VOLTAGE RANGE

50 to 600 Volts

## CURRENT

8.0 Ampere

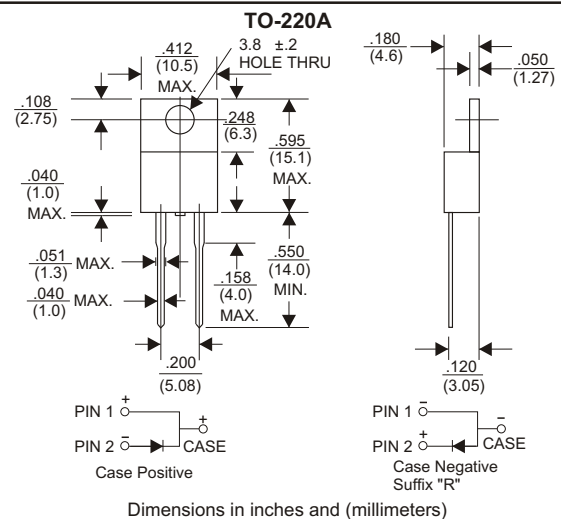

## MAXIMUM RATINGS AND ELECTRICAL CHARACTERISTICS

Rating 25°C ambient temperature unless otherwise specified.  
Single phase half wave, 60Hz, resistive or inductive load.  
For capacitive load, derate current by 20%.

TYPE NUMBER	HER801	HER802	HER803	HER804	HER805	HER806	UNITS
Maximum Recurrent Peak Reverse Voltage	50	100	200	300	400	600	V
Maximum RMS Voltage	35	70	140	210	280	420	V
Maximum DC Blocking Voltage	50	100	200	300	400	600	V
Maximum Average Forward Rectified Current .375"(9.5mm) Lead Length at Tc=75°C	8.0						A
Peak Forward Surge Current, 8.3 ms single half sine-wave superimposed on rated load (JEDEC method)	150						A
Maximum Instantaneous Forward Voltage at 8.0A	1.0		1.3		1.85		V
Maximum DC Reverse Current Tc=25°C	10.0						µA
at Rated DC Blocking Voltage Tc=100°C	200						µA
Maximum Reverse Recovery Time (Note 1)	60					100	nS
Typical Junction Capacitance (Note 2)	65						pF
Operating and Storage Temperature Range Tj, Tstg	-55 — +150						°C

### NOTES:

- Reverse Recovery Time test condition: IF=0.5A, IR=1.0A, IRR=0.25A
- Measured at 1MHz and applied reverse voltage of 4.0V D.C.

# RATING AND CHARACTERISTIC CURVES (HER801 THRU HER807)

FIG.1-TYPICAL FORWARD CHARACTERISTICS

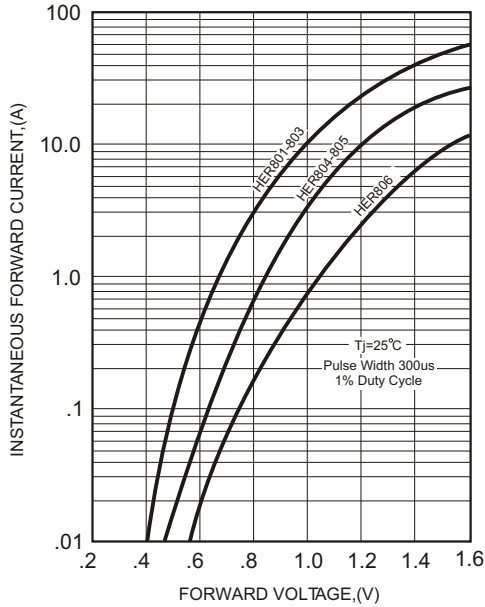

FIG.2-TYPICAL FORWARD CURRENT DERATING CURVE

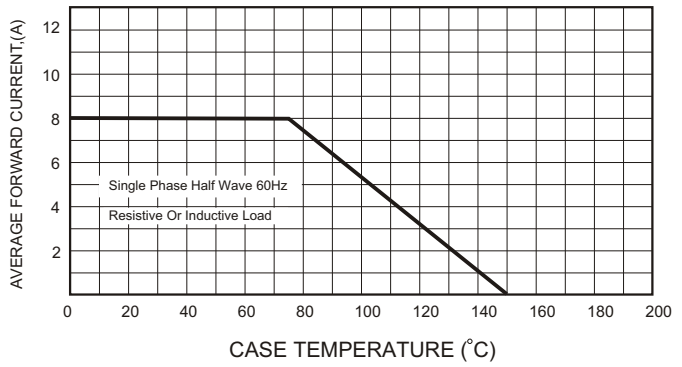

FIG.4-MAXIMUM NON-REPETITIVE FORWARD SURGE CURRENT

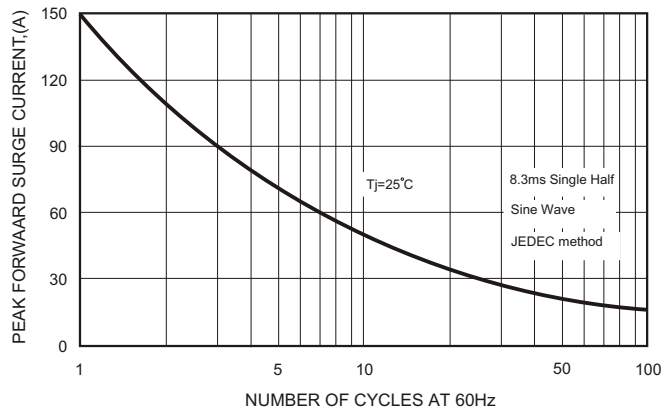
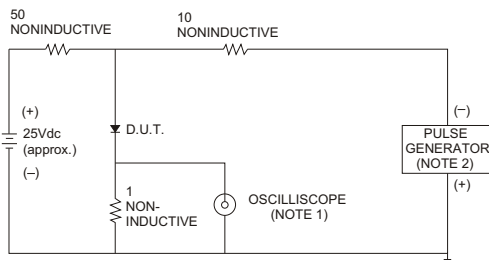

FIG.3- TEST CIRCUIT DIAGRAM AND REVERSE RECOVERY TIME CHARACTERISTICS



- NOTES: 1. Rise Time= 7ns max., Input Impedance= 1 megohm, 22pF.  
2. Rise Time= 10ns max., Source Impedance= 50 ohms.

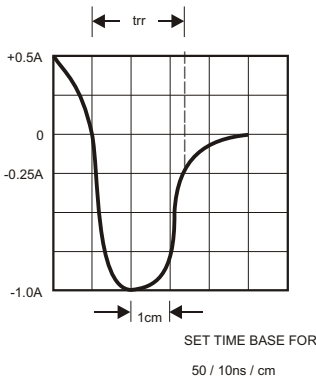

FIG.5-TYPICAL JUNCTION CAPACITANCE

