

SR16200CT



16 AMP SCHOTTKY BARRIER RECTIFIERS



FEATURES

- * Low forward voltage drop
- * High current capability
- * High reliability
- * High surge current capability
- * Epitaxial construction

MECHANICAL DATA

- * Case: Molded plastic
- * Epoxy: UL 94V-0 rate flame retardant
- * Lead: Lead solderable per MIL-STD-202, method 208 guaranteed
- * Polarity: As Marked
- * Mounting position: Any
- * Weight: 2.24 grams

VOLTAGE RANGE

200 Volts

CURRENT

16 Ampere

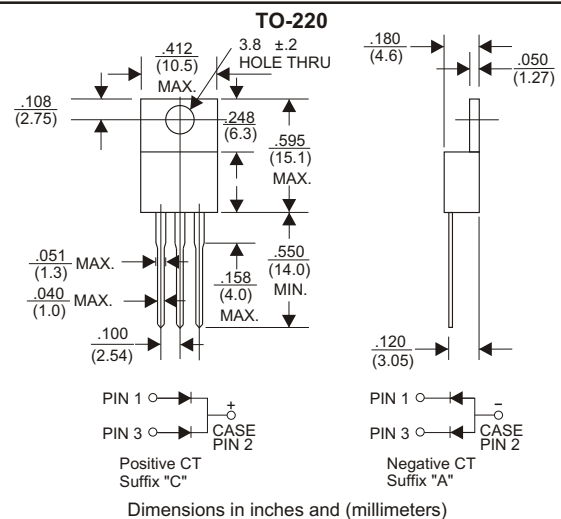

MAXIMUM RATINGS AND ELECTRICAL CHARACTERISTICS

Rating 25°C ambient temperature unless otherwise specified.
Single phase half wave, 60Hz, resistive or inductive load.
For capacitive load, derate current by 20%.

TYPE NUMBER	SR16200CT	UNITS
Maximum Recurrent Peak Reverse Voltage	200	V
Maximum RMS Voltage	140	V
Maximum DC Blocking Voltage	200	V
Maximum Average Forward Rectified Current .375"(9.5mm) Lead Length at Tc=105°C	16	A
Peak Forward Surge Current, 8.3 ms single half sine-wave superimposed on rated load (JEDEC method)	150	A
Maximum Instantaneous Forward Voltage at 8A	0.90	V
Maximum DC Reverse Current Ta=25°C	0.02	mA
at Rated DC Blocking Voltage Ta=125°C	10	mA
Typical Junction Capacitance (Note1)	300	pF
Typical Thermal Resistance R JA (Note 2)	3.0	°C/W
Operating Temperature Range Tj	-55 — +150	°C
Storage Temperature Range Tstg	-55 — +175	°C

NOTES:

1. Measured at 1MHz and applied reverse voltage of 4.0V D.C.
2. Thermal Resistance Junction to Ambient Vertical PC Board Mounting 0.5"(12.7mm) Lead Length.

RATING AND CHARACTERISTIC CURVES (SR16200CT)

FIG.1-TYPICAL FORWARD CURRENT DERATING CURVE

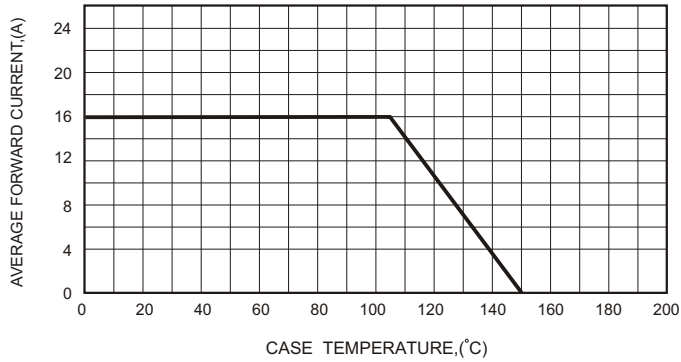

FIG.2-TYPICAL FORWARD CHARACTERISTICS

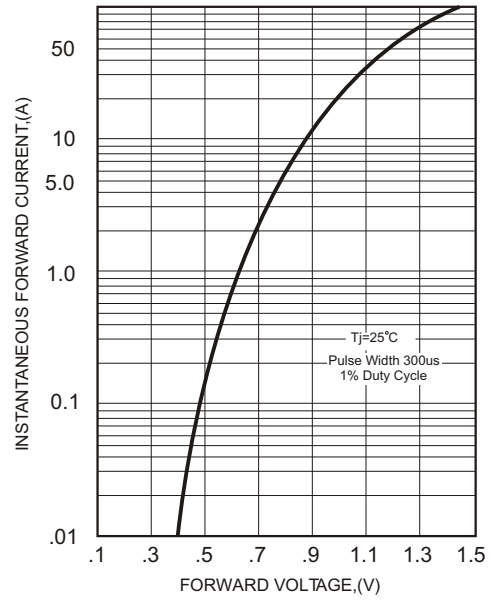

FIG.3-MAXIMUM NON-REPETITIVE FORWARD SURGE CURRENT

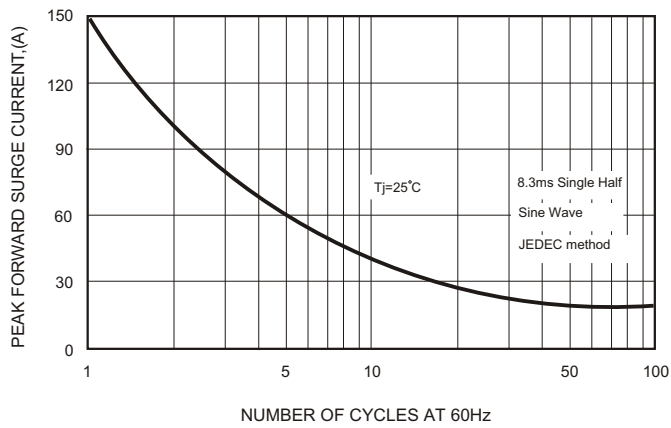

FIG.5 - TYPICAL REVERSE CHARACTERISTICS

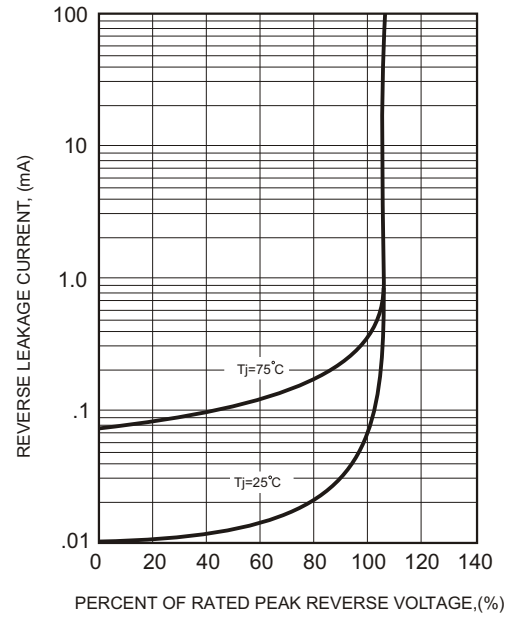

FIG.4-TYPICAL JUNCTION CAPACITANCE

