

Barrier Style Terminal Blocks / DT-49

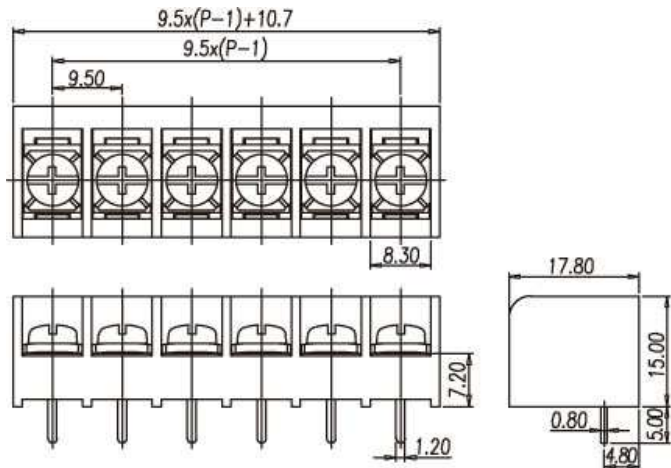

DT-49-B01W-XX

Pole number : 02~31 / 極数



Pitch: 9.5mm

FW2		UL	
Approval / 取得安全規格 / 認證	UL		
Electrical / 電気仕様 / 電器規格			
Rated voltage / 定格電圧 / 電壓	300V	300V	
Rated current / 定格電流 / 電流	25A	10A	
UG	B	D	
Wire range / 使用線径 / 線徑	22~12 AWG		
Withstand Voltage / 耐電圧 / 耐電壓	AC2000V for 1 minute		
Insulation Resistance / 絶縁抵抗 / 絶縁阻抗	500MΩ / DC 500V		
Materials / 材質及び規格 / 材質規格			
Plastic Housing / 本体 / 本體	PA66, UL94V-0, Black		
Operating Temperature / 使用温度範囲 / 温度	-40°C ~ +105°C		
Terminal / 導電板 / 端子	Brass, Tin plated		
Screw / 結線ビス / 螺絲	Steel, #6-32, Nickel plated		
Torque Value / ネジ締付トルク / 扭力値	1.4 N-m		



Drilling plan

