

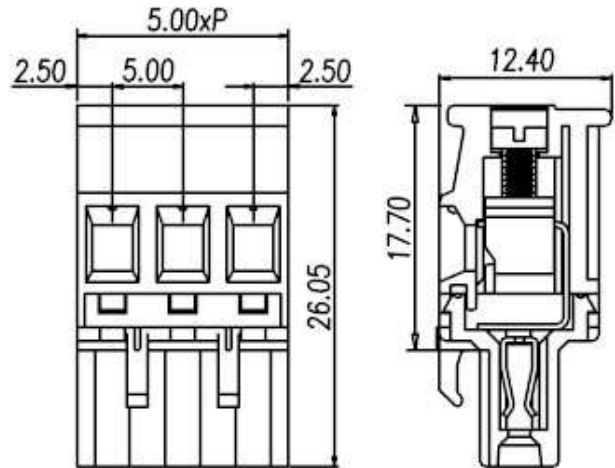



Plugs for pluggable terminal blocks / EC & ESD series



5ESDP



Pitch: 5.00mm

Approval	  	
Technical Data	UL	IEC
Rated voltage	300V	600V
Rated current	15A	18A
Conductor cross-section, solid (AWG/ mm ²)	28~12 / 0.2~2.5	
Conductor cross-section, flexible (AWG/ mm ²)	30~12 / 0.2~2.5	
Rated surge voltage (UL/IEC/Max.)	1.6 / 4/ 4 KV	
Torque (N-m)	0.51	
Screw	M2.5	
Wire strip length	7~8mm	
Pole	Cat. No.	
02	5ESDP-02P	
:	:	
:	:	
24	5ESDP-24P	

TEL: +886-2-2908-0614

FAX: +886-2-2908-8549

E-mail: info@dinkle.com.tw