

MicroSmart AS-Interface Master Module

Capable of Connecting 62 Slaves

- Compliance with AS-Interface Ver. 2.1 specifications
- Digital and analog slaves can be connected.
- Configuration and slave monitoring can be done using LED indicators and pushbuttons on the front panel as well as using WindLDR.
- Analog signals can also be processed using built-in analog voltage input terminal or optional analog I/O modules.
- IEC62026-2 compliant.



PLCs

Operator Interfaces

Part Numbers

AS-Interface Master Module

	Part Number
	FC4A-AS62M

Programming and Monitoring Software

	Part Number
WindLDR 	FC9Y-LP2CDW

Automation Software



MicroSmart Pentra CPU

All-In-One Type

	Part Number	Power	I/O Points	Input	Output	Expandability
	FC5A-C24R2C	24V DC	24 (14 in/10 out)	24V DC (Sink/Source)	Relay	88 maximum I/O (up to 4 expansion modules)
	FC5A-C24R2	100-240V AC				

Power Supplies

Slim Type



	Part Number	Power	I/O Points	Input	Output	Expandability
	FC5A-D16RK1	24V DC	16 (8 in/8 out)	24V DC (Sink/Source)	6 Relays 2 Transistor Sink	496 (up to 15 expansion modules)
	FC5A-D16RS1				6 Relays 2 Transistor Source	
	FC5A-D32K3	24V DC	32 (16 in/16 out)	24V DC (Sink/Source)	Transistor Sink	512 (up to 15 expansion modules)
	FC5A-D32S3				Transistor Source	

Sensors

Communication & Networking

MicroSmart Slim CPU

PLCs

	Part Number	Power	I/O Points	Input	Output	Expandability
	FC4A-D20RK1	24V DC	20 (12 in/8 out)	24V DC (Sink/Source)	6 Relays 2 Transistor Sink	244 (up to 7 expansion modules)
	FC4A-D20RS1				6 Relays 2 Transistor Source	
	FC4A-D40K3		40 (24 in/16 out)		Transistor Sink	264 (up to 7 expansion modules)
	FC4A-D40S3				Transistor Source	

Operator Interfaces

Accessories

Automation Software

	Description	Part Number
	Terminal Block for AS-Interface Master Module 3-pole	FC4A-PMT3

Power Supplies

Sensors

Specifications (AS-Interface Master Module)

General Specifications

Operating Temperature	0 to 55°C (no freezing)
Storage Temperature	-25 to +70°C (no freezing)
Relative Humidity	Level RH1, 30 to 90% (non-condensing)
Pollution Degree	2 (IEC60664)
Degree of Protection	IP20
Corrosion Immunity	Atmosphere free from corrosive gases
Altitude	Operation: 0 to 2000m Transport: 0 to 3000m
Vibration Resistance	<ul style="list-style-type: none"> When mounted on a DIN rail: 10 to 57 Hz amplitude 0.075mm, 57 to 150 Hz acceleration 9.8 m/s² (1G) 2 hours per axis on each of three mutually perpendicular axes When mounted on a panel surface: 2 to 25 Hz amplitude 1.6mm, 25 to 100 Hz acceleration 39.2 m/s² (4G) 90 minutes per axis on each of three mutually perpendicular axes
Shock Resistance	147 m/s ² (15g), 11ms duration, 3 shocks on each of three mutually perpendicular axes (IEC61131)

Functional Specifications

External Power Supply	AS-Interface power supply, 29.5 to 31.6V DC
AS-Interface	65mA (normal operation)
Current	110mA maximum
Effect of Improper Input Connection	No damage
Connector on Mother Board	MSTB2.5/3-GF-5.08BK (Phoenix Contact) Insertion/removal durability: 100 times minimum
Internal Current	80mA (5V DC)
AS-Interface Master Module Power Consumption	540mW (24V DC)
Weight (approx.)	85g

Communication Specifications

Maximum Bus Cycle	When 1 through 19 slaves are connected: 3ms When 20 through 62 slaves are connected: 0.156 x (1 + N) ms, where N is the number of active slaves 5ms maximum when 31 slaves are connected 10ms maximum when 62 slaves are connected
Maximum Slaves	Standard slaves: 31 A/B slaves: 62
Maximum I/O Points	Standard slaves: 248 total (124 inputs + 124 outputs) A/B slaves: 434 total (248 inputs + 186 outputs)
AS-Interface Cable Maximum Length	When using no repeater or extender: 100m When using a total of 2 repeaters or extenders: 300m
Rated Bus Voltage	30V DC

Dimensions

FC4A-AS62M

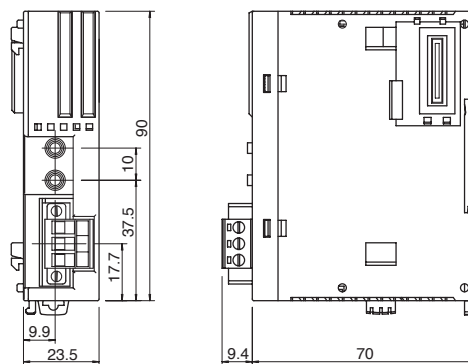

All dimensions in mm.

Installation Location

- MicroSmart modules must be installed correctly for optimum performance.
- MicroSmart is designed for installation in a cabinet. Do not install the MicroSmart outside a cabinet.
- The environment for using the MicroSmart is "Pollution degree 2." Use the MicroSmart in environments of pollution degree 2 (according to IEC60664-1).
- Make sure that the operating temperature does not drop below 0°C or exceed 55°C. If the temperature does exceed 55°C, use a fan or cooler.
- Mount the MicroSmart on a vertical plane as shown at right.
- To eliminate excessive temperature build-up, provide ample ventilation. Do not install the MicroSmart near, and especially above, any device which generates considerable heat, such as a heater, transformer, or large-capacity resistor. Relative humidity should be above 30% and below 95%.
- MicroSmart should not be exposed to excessive dust, dirt, salt, direct sunlight, vibrations, or shocks. Do not use the MicroSmart in an area where corrosive chemicals or flammable gases are present. The modules should not be exposed to chemical, oil, or water splashes.

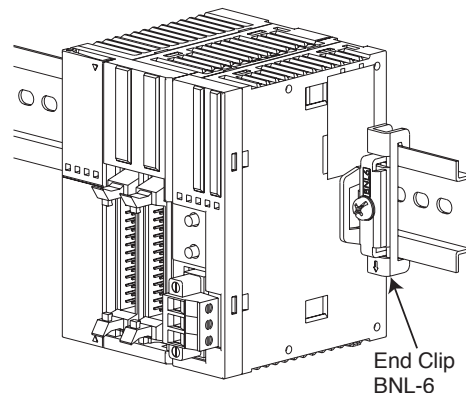

Cable Connection



Caution: • Make sure that operating conditions are within the specification values.

- Connect ground terminal of the CPU module to a proper ground, otherwise electric shock may occur.
- Do not touch live terminals, otherwise electric shock may occur.
- Applicable ferrules, crimping tool and screwdriver are listed below.
- When connecting stranded wire or multiple wires to a screw terminal block, use a ferrule.

Ferrules for Terminal Block

Cross-section 0.5mm² (20AWG)
 For 1-cable connection: AI 0.5-8 WH
 For 2-cable connection: AI-TWIN 2 x 0.5-8 WH

Cross-section 0.75mm² (18AWG)
 For 1-cable connection: AI 0.75-8 WH
 For 2-cable connection: AI-TWIN 2 x 0.75-8 GY

Cross-section 1.5mm² (16AWG)
 For 1-cable connection: AI 1,5-8 BK

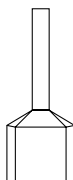

Crimping Tool

CRIMPFOX ZA 3 (Phoenix Contact)

Screwdriver

SZS 0.6x3.5 (Phoenix Contact)

Screw Tightening Torque

AS-Interface connector terminal screws: 0.5 to 0.6 N•m
 AS-Interface connector mounting screws: 0.3 to 0.5 N•m

AS-Interface Cable Wiring

Before wiring the AS-Interface cable, remove the AS-Interface cable terminal block from the AS-Interface cable connector on the AS-Interface master module.

Insert the terminal block to the connector on the AS-Interface master module, and tighten the mounting screws to a torque of 0.3 to 0.5 N•m.

AS-Interface specifies use of brown cables for the AS-Interface + line, and blue cables for the AS-Interface – line. Connect the cables according to the colors indicated on the terminal block. Tighten the terminal screws to a torque of 0.5 to 0.6 N•m (Replacement terminal block: FC4A-PMT3PN02, package quantity: 2)

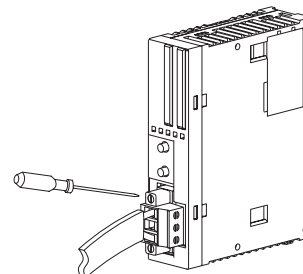
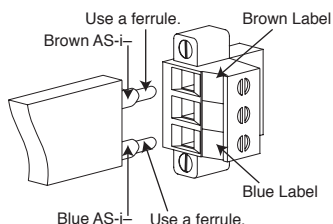

PS2R AS-Interface Power Supply

AS-Interface Power Supply with Universal AC Input Voltage

- Input voltage range: 100 to 240V AC
- Two output ratings: 73W and 145W
- Slim housing style mountable on DIN rails
- IP20 finger-safe terminals
- CE marked (LVD, EMC/D)
- UL listed (UL 508), CSA (C22.2 No. 950), TÜV (EN60950, EN61010-1)
- Noise standards EN55022, EN61000-6-2 compliant
- Input indicator (orange) and output indicator (green)
- IEC62026-2 compliant



Part Numbers

AS-Interface Power Supply

	Output Capacity	Input Voltage	Output Voltage	Part Numbers
	73W	100 to 240V AC	30.5V DC	PS2R-Q30ABL
	145W			PS2R-F30ABL

PLCs

Operator Interfaces

Automation Software

Power Supplies

Sensors

Communication & Networking

Specifications

Model		PS2R-Q30ABL	PS2R-F30ABL	
PLCs	Efficiency	83% (typical) at the rated input/output		
	Voltage	100 to 240V AC (85 to 264V AC)		
	Frequency	47 to 63 Hz		
	Input Current	100V AC	1.8A (typical) at the rated load	3.0A (typical) at the rated load
		220V AC	1.0A (typical) at the rated load	2.0A (typical) at the rated load
	Leakage Current	3.5mA maximum (UL, CSA, VDE)		
Inrush Current	30A maximum (25°C at cold start)			
Operator Interfaces	Rated Voltage	30.5V DC		
	Rated Current	2.4A	4.8A	
	Adjustable Voltage Range	N/A		
	Ripple Noise Voltage	300mV p-p maximum (0 to 10 kHz), 50mV p-p maximum (10 to 500 kHz) according to AS-Interface standard		
	Input/Load Fluctuation	3%		
	Overall Fluctuation	29.5 to 31.6V DC including input fluctuation, output fluctuation, temperature fluctuation and ripple voltage		
	Delay Time	2 sec maximum (delay in output voltage change from 5V to 26.5V) according to AS-Interface standard		
	Startup Time	1 sec maximum (output voltage change from 21.5V to 29.5V) according to AS-Interface standard		
	Output Holding Time	10ms minimum at 85V AC, rated load		
	Automation Software	Overcurrent Protection	110% (typical), automatic reset ¹	
Overvoltage Protection		120% minimum ²		
Undervoltage Protection		95% maximum, automatic reset		
Input Indicator		Orange		
Output Indicator		Green		
Dielectric Strength		Between inputs and outputs: Between inputs and ground: Between outputs and ground:	3.0 kV AC, 1 minute 3.0 kV AC, 1 minute 0.5 kV AC, 1 minute	
Insulation Resistance		Between inputs and outputs: Between inputs and ground:	100 MΩ minimum (500V DC megger) 100 MΩ minimum (500V DC megger)	
Operating Temperature		0 to 60°C (See the derating curve.) Vertical mounting only		
Storage Temperature		-25 to +70°C (no freezing, non-condensation)		
Operating Humidity		95% RH (non-condensation)		
Vibration Resistance		10 to 57 Hz amplitude 0.075mm, 57 to 150 Hz acceleration 10 m/s ² (1G) 10 cycles per axis on each of three mutually perpendicular axes		
Shock Resistance		147 m/s ² (15G), 11ms duration, 2 shocks per axis, on six mutually perpendicular axes		
Terminal		IP20		
Weight (approx.)		800g	1300g	
Dimensions		120H x 54W x 120D mm	120H x 81W x 120D mm	
Safety Standards		UL 508 listed CSA C22.2 No. 950 EN60950, EN61010		
AS-Interface Standard		EN50295		
EMC	(EMI) Radiated Emission	IEC61000-6-2 EN55022 class B		
	Conducted Emission	EN55022 class B		



1. The AS-Interface power supply is provided with an overvoltage protection circuit, but a long period of overload and short-circuit should be avoided.
2. After turning off the input voltage, allow more than 10 seconds before turning on again.

Block Diagram

PS2R-Q30ABL
PS2R-F30ABL

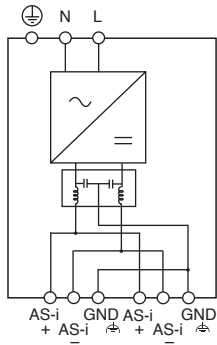

Output Derating

(Operating temperature is the temperature around the power supply)

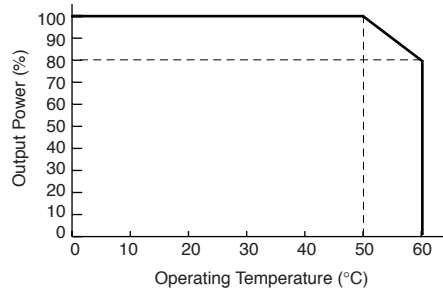

Terminal Names

- ① (L) AC input terminal
- ② (N) AC input terminal (ground side)
- ③ (⊕) Ground terminal (protective ground)
- ④ (AS-+) AS-Interface + output terminal
- ⑤ (AS-) AS-Interface - output terminal
- ⑥ (⊖) Ground terminal (output side)
- ⑦ (-) Input indicator (goes on when AC input is on)
- ⑧ (AS-i) Output indicator (goes on when DC output is on)

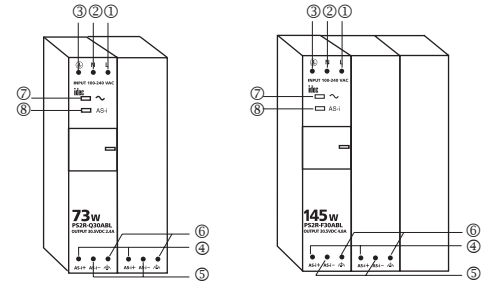

Dimensions

PS2R-Q30ABL

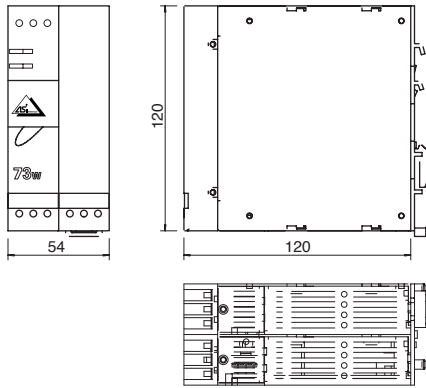

PS2R-F30ABL

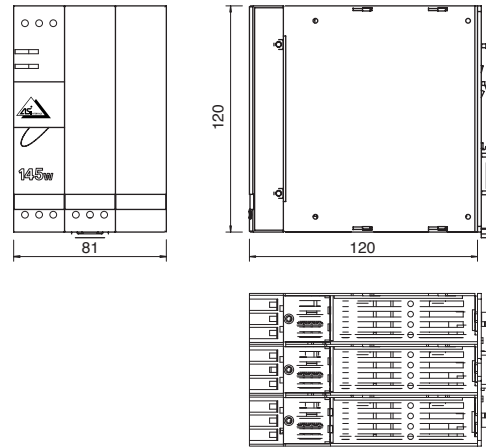

All dimensions in mm.

Precautions for Installation

1. Heat Dissipation by Convection

Keep minimum spacing of 50mm above and below, and 15mm on both sides to ensure proper ventilation.

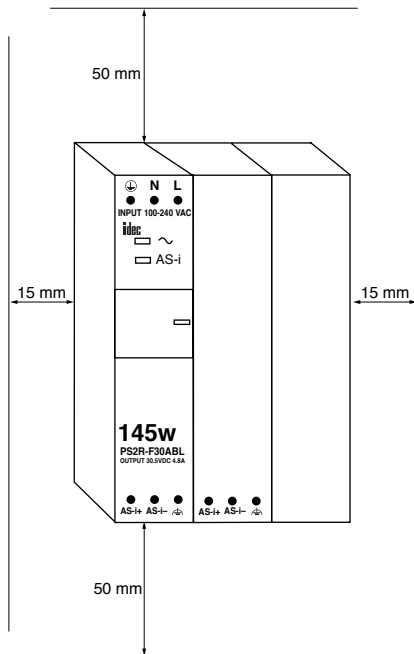

2. Applicable Wires, Ferrules and Tightening Torque



Ferrule/ Wire					
mm ²	0.14 to 1.5	0.14 to 0.75	0.14 to 2.5	0.14 to 4	0.14 to 1.5
AWG	26 to 16	26 to 18	26 to 14	26 to 12	26 to 16

			0.6 N•m
ø3.5mm	C		5.4 in•lbs

3. Mounting on 35mm-wide DIN Rails

Mounting

To mount the power supply on a DIN rail, place the input terminal side up and put the groove of the power supply on the DIN rail as shown. Press the power supply towards the DIN rail.

Removing

Insert a flat screwdriver into the slot in the clamp. While pulling out the clamp, turn the power supply bottom out.

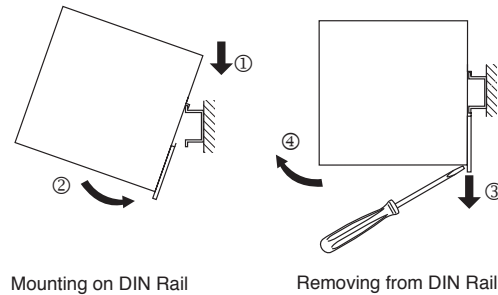

Mounting Direction

The AS-Interface power supply can be mounted on a vertical plane only. Other mounting directions are not allowed because of heat dissipation.

Over Current Protection

When an overcurrent of 110% of the rated output current flows due to an overload, the output voltage drops automatically and intermittent operation starts.

When the load returns to normal conditions, the normal output voltage is automatically restored. Prevent overload or short-circuitry for a long period of time, otherwise the internal elements will be damaged.

Overvoltage Protection

When the output voltage exceeds 120% the rated output voltage, the output is turned off. When the output voltage is turned off due to an overvoltage, turn the input off, and after more than 10 seconds, turn the input on again.

Undervoltage Protection

When the output voltage drops below 95% the rated output voltage, the output is turned off. When the cause of the error is removed, normal output voltage is automatically restored.