

High Isolation Voltage Single Transistor Type Multi Photocoupler Series PS2561-1,-2, PS2561L-1,-2

■ Features

- High isolation voltage $B_v = 5\,000\text{ Vr.m.s.}$: standard products
 $B_v = 3\,750\text{ Vr.m.s.}$: VDE0884 approved products (Option)
- High collector to emitter voltage ($V_{CE0} = 80\text{ V}$)
- High current transfer ratio ($CTR = 200\% \text{ TYP.}$)
- High-speed switching ($t_r = 3\ \mu\text{s TYP.}$, $t_f = 5\ \mu\text{s TYP.}$)

■ Package Dimensions (In millimeters)

DIP Type

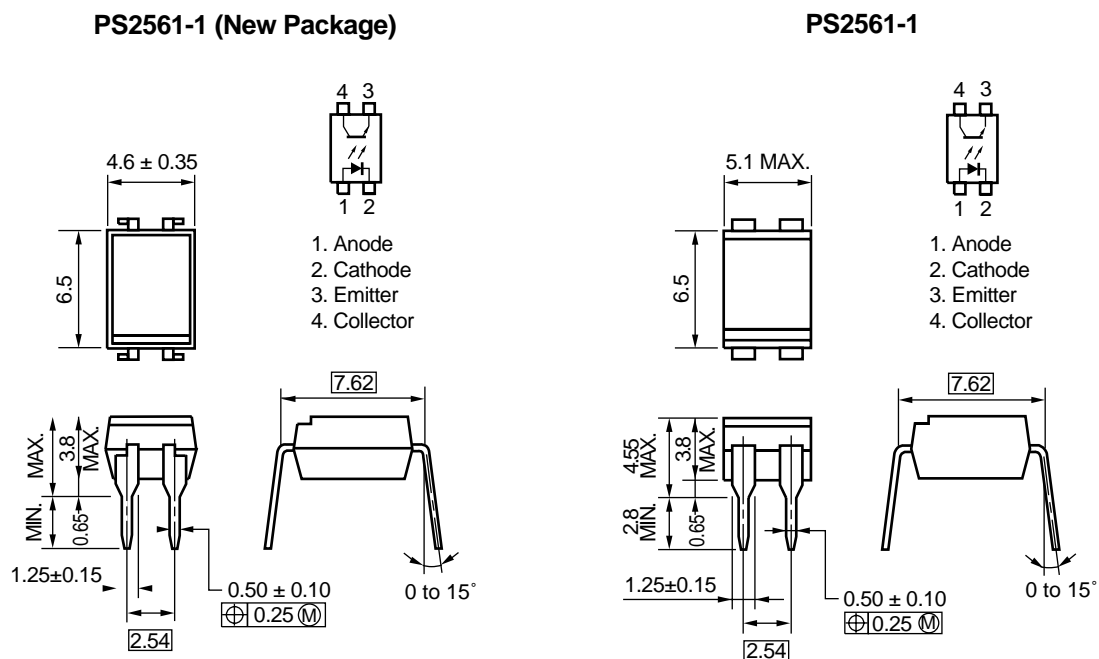

PS2561-1,-2, PS2561L-1,-2

DIP Type

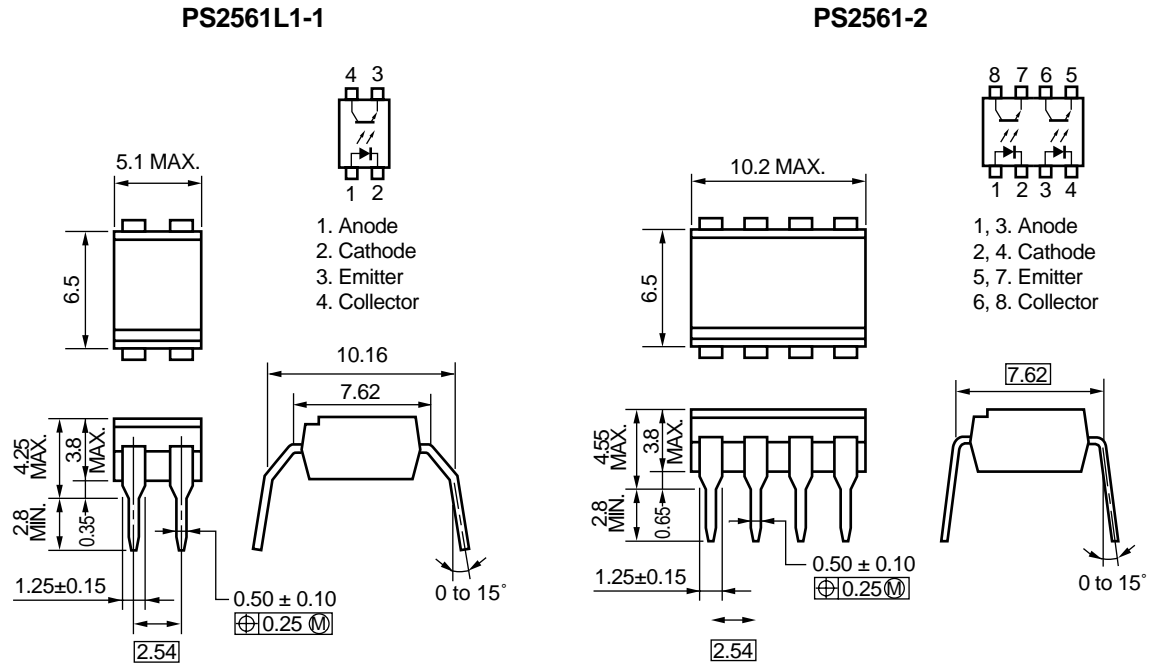

Lead Bending Type

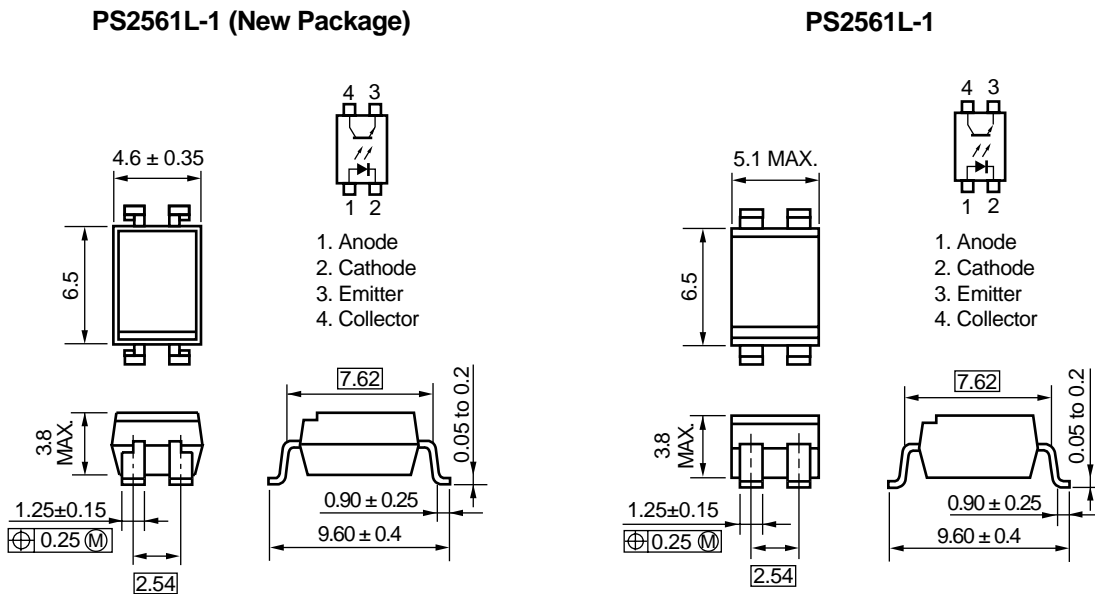

PS2561-1,-2, PS2561L-1,-2

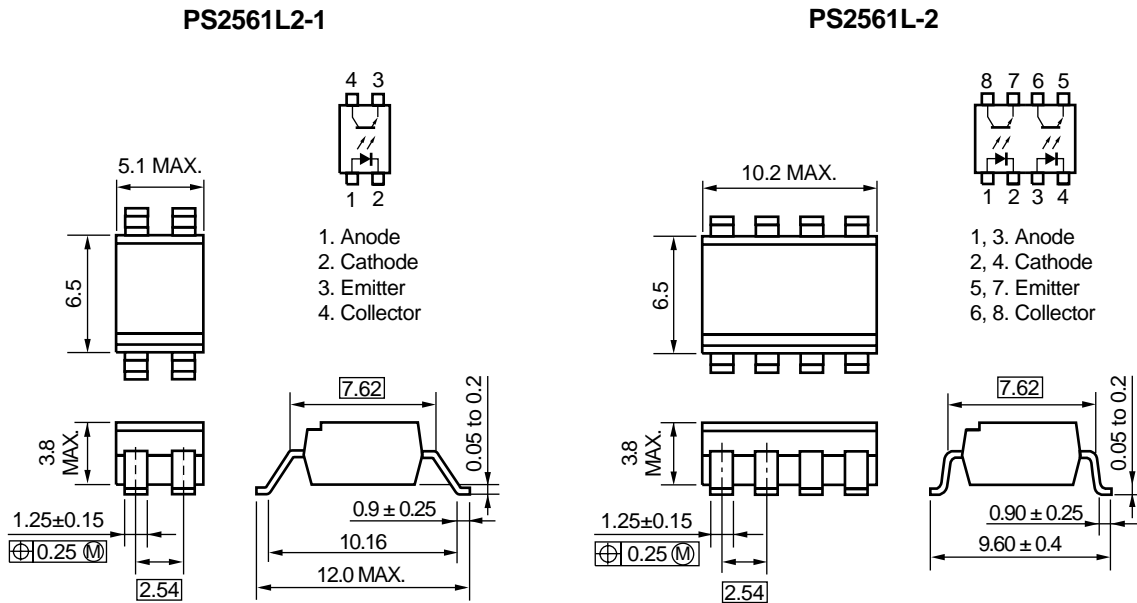

■ Absolute Maximum Ratings Ta = 25°C

Parameter	Symbol	Ratings		Unit	
		PS2561-1, PS2561L-1	PS2561-2, PS2561L-2		
Diode	Reverse Voltage	V _R	6		V
	Forward Current (DC)	I _F	80		mA
	Power Dissipation Derating	ΔP _D /°C	1.5	1.2	mW/°C
	Power Dissipation	P _D	150	120	mW/ch
	Peak Forward Current ^{*1}	I _{FP}	1		A
Transistor	Collector to Emitter Voltage	V _{CEO}	80		V
	Emitter to Collector Voltage	V _{ECO}	7		V
	Collector Current	I _C	50		mA/ch
	Power Dissipation Derating	ΔP _C /°C	1.5	1.2	mW/°C
	Power Dissipation	P _C	150	120	mW/ch
Isolation Voltage ^{*2}	BV	5000 3 750 ^{*3}		Vr.m.s.	
Operating Ambient Temperature	T _A	-55 to +100		°C	
Storage Temperature	T _{stg}	-55 to +150		°C	

*1 PW = 100 μs, Duty Cycle = 1 %

*2 AC voltage for 1 minute at T_A = 25 °C, RH = 60 % between input and output

*3 VDE0884 approved products (Option)

PS2561-1,-2, PS2561L-1,-2

■ Typical Characteristics (TA=25°C, unless otherwise specified)

Parameter		Symbol	Conditions	MIN.	TYP.	MAX.	Unit
Diode	Forward Voltage	V_F	$I_F = 10 \text{ mA}$		1.17	1.4	V
	Reverse Current	I_R	$V_R = 5 \text{ V}$			5	μA
	Terminal Capacitance	C_t	$V = 0 \text{ V}, f = 1.0 \text{ MHz}$		50		pF
Transistor	Collector to Emitter Dark Current	I_{CEO}	$V_{CE} = 80 \text{ V}, I_F = 0 \text{ mA}$			100	nA
Coupled	Current Transfer Ratio ^{*1}	CTR	$I_F = 5 \text{ mA}, V_{CE} = 5 \text{ V}$	80	200	400	%
	Collector Saturation Voltage	$V_{CE(sat)}$	$I_F = 10 \text{ mA}, I_C = 2 \text{ mA}$			0.3	V
	Isolation Resistance	R_{I-O}	$V_{I-O} = 1.0 \text{ kV}$	10^{11}			Ω
	Isolation Capacitance	C_{I-O}	$V = 0 \text{ V}, f = 1.0 \text{ MHz}$		0.5		pF
	Rise Time ^{*2}	t_r	$V_{CC} = 10 \text{ V}, I_C = 2 \text{ mA}, R_L = 100 \Omega$		3		μs
Fall Time ^{*2}	t_f			5			

*1 CTR rank (only PS2561-1, PS2561L-1)

L : 200 to 400 (%)
M : 80 to 240 (%)
D : 100 to 300 (%)
H : 80 to 160 (%)
W : 130 to 260 (%)

*2 Test circuit for switching time

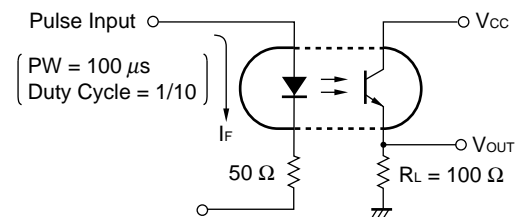

PS2561-1,-2, PS2561L-1,-2

■ Electrical Characteristics $T_a = 25^\circ\text{C}$

DIODE POWER DISSIPATION vs. AMBIENT TEMPERATURE

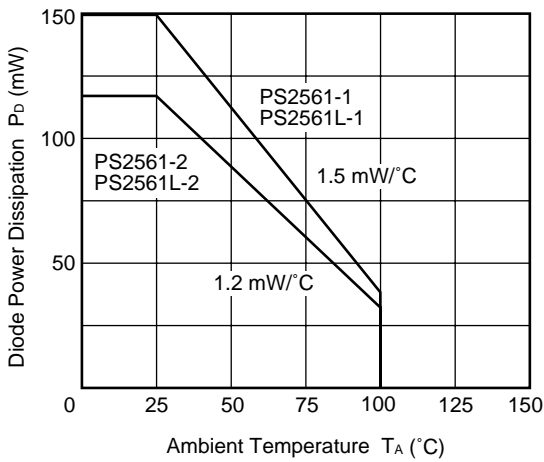

TRANSISTOR POWER DISSIPATION vs. AMBIENT TEMPERATURE

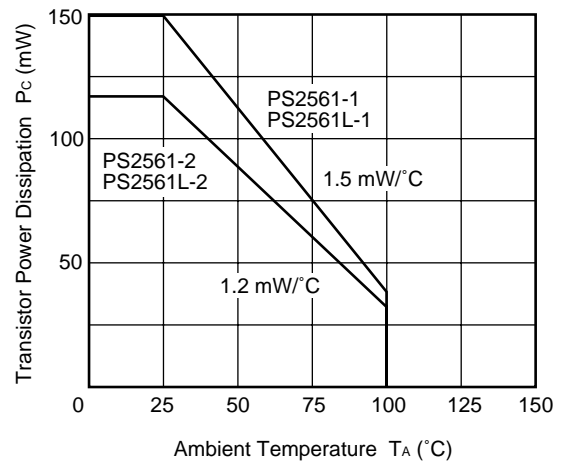

FORWARD CURRENT vs. FORWARD VOLTAGE

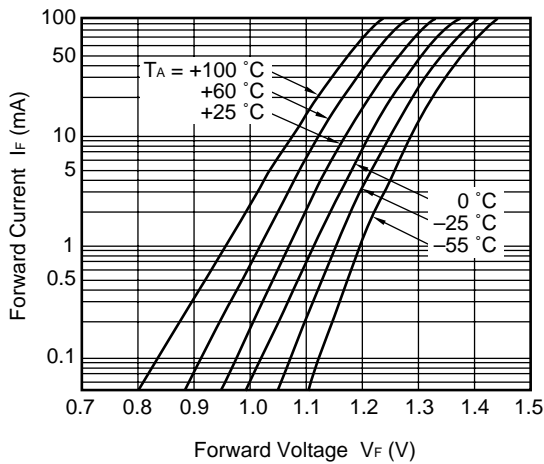

COLLECTOR CURRENT vs. COLLECTOR TO EMITTER VOLTAGE

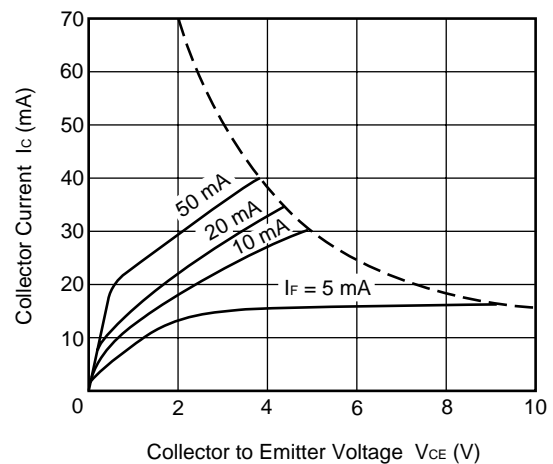

COLLECTOR TO EMITTER DARK CURRENT vs. AMBIENT TEMPERATURE

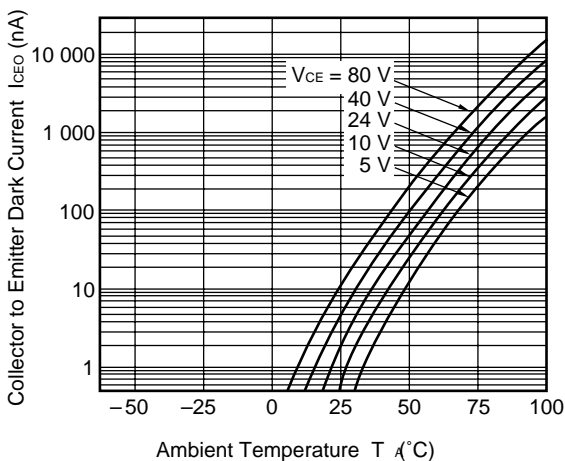

COLLECTOR CURRENT vs. COLLECTOR SATURATION VOLTAGE

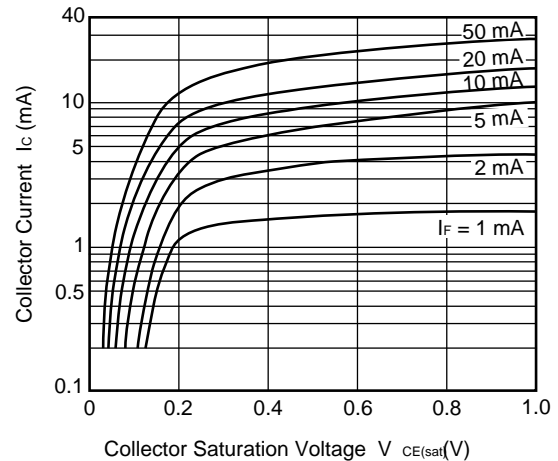

PS2561-1,-2, PS2561L-1,-2

NORMALIZED CURRENT TRANSFER RATIO vs. AMBIENT TEMPERATURE

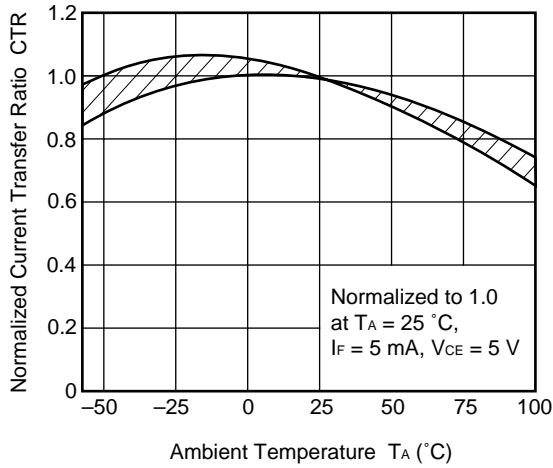

CURRENT TRANSFER RATIO vs. FORWARD CURRENT

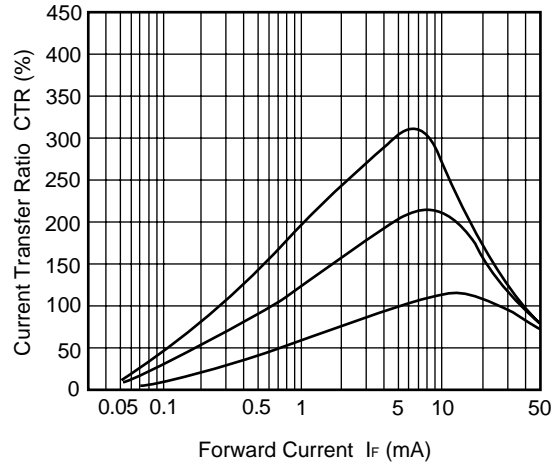

SWITCHING TIME vs. LOAD RESISTANCE

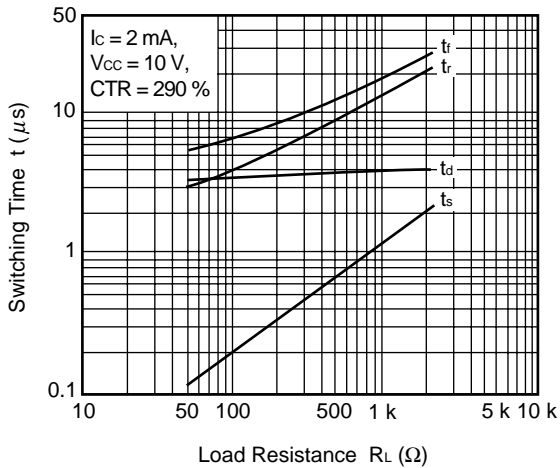

SWITCHING TIME vs. LOAD RESISTANCE

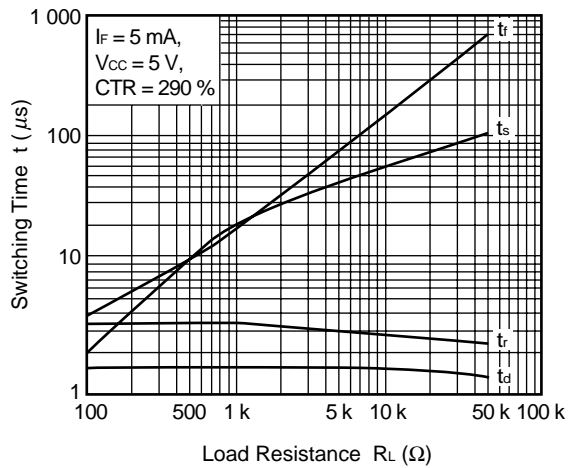

FREQUENCY RESPONSE

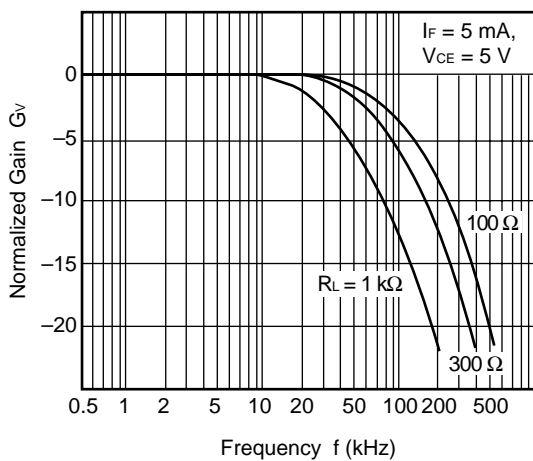

LONG TIME CTR DEGRADATION

