

PFM Step-up DC/DC Converter With High Efficiency And Low Noise

KX8530

■ Outline

The KX8530 series are CMOS-based PFM step-up DC-DC Converter. The converter can start up by supply voltage as low as 0.8V, and capable of delivering maximum 200mA output current at 3.3V output with 1.8V input Voltage. Quiescent current drawn from power source is as low as 7 μ A. All of these features make KX8530 series be suitable for the portable devices, which are supplied by a single battery to four-cell batteries.

To reduce the noise caused by the switch regulator, KX8530 is well considered in circuit design and manufacture. So that the interferer to other circuits by the device is reduced greatly.

KX8530 integrates stable reference circuits and trimming technology, so it can afford high precision and low temperature-drift coefficient of the output voltage.

KX8530 is available in SOT-89、SOT-23 and SOT-153 packages which is PB free. And in 5-pin packages, such as SOT-153, the device can be switch on or off easily by CE pin, to minimize the standby supply current.

■ Features

- Deliver 200mA at 3.3V Output voltage with 1.8V input Voltage
- Low start-up voltage (when the output current is 1mA)-----0.8V
- The converter output voltage can be adjusted from 2.5V~6.0V(In 0.1V step).
- Output voltage accuracy ----- \pm 2%
- Low temperature-drift coefficient of the output voltage----- \pm 100ppm/ $^{\circ}$ C
- Only three external components are necessary: An inductor, a Schottky diode and an output filter capacitor
- High power conversion efficiency-----85%
- Low quiescent current drawn from power source----- $<$ 7 μ A

■ Applications

- Power source for PDA、DSC、MP3 Player、electronic toy and wireless mouse
- Power source for a single or dual-cell battery-powered equipments
- Power source for LED

■ PIN Configuration

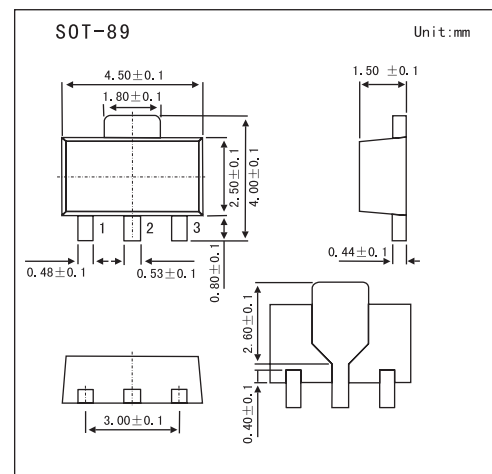
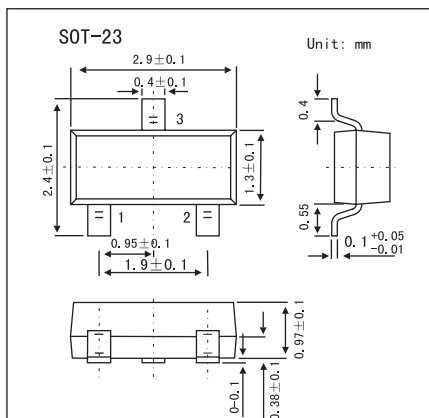

KX8530

■ Selection Guide

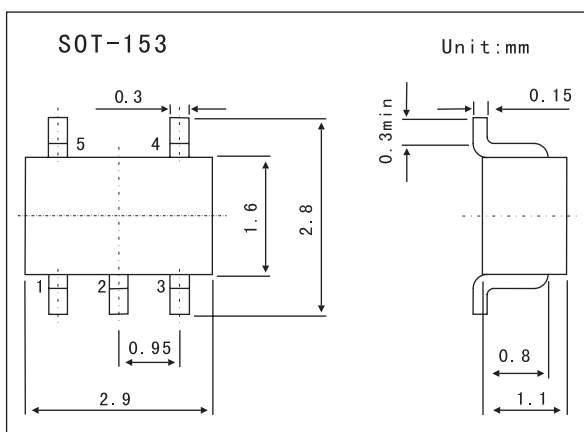

KX8530--XX X XX

Package Type:
 RN:SOT-153
 RM:SOT-23
 SM:SOT-89

Function Description:
 1: Internal Tr. Driver,
 Without Enable circuit
 2: Internal Tr. Driver,
 With Enable circuit
 3: External Tr. Driver,
 Without Enable circuit
 4: External Tr. Driver,
 With Enable circuit

Output Voltage:
 25.... 2.5V
 30.... 3.0V

 60.... 6.0V (In 0.1V step)

■ PIN Description

Pin No.			Symbol	Description
SOT-89	SOT-23	SOT-153		
1	1	4	V _{ss} (GND)	Ground pin
2	2	2	V _{out}	Output pin, power supply for internal circuits
3	3	5	L _x (Ext)	Switching pin
		3	NC	
		1	CE	Chip enable pin (active high)

■ PRODUCTOR LIST :

Product Name	Output Voltage	Lx Tr. Driver	Chip Enable	Package
KX8530-XX1SM	XX V	Internal	No	SOT-89
KX8530-XX1RM	XXV	Internal	No	SOT-23
KX8530-XX2RN	XXV	Internal	Yes	SOT-153
KX8530-XX3SM	XXV	External	No	SOT-89
KX8530-XX3RM	XXV	External	No	SOT-23
KX8530-XX4RN	XXV	External	Yes	SOT-153

KX8530

■ Block Diagram

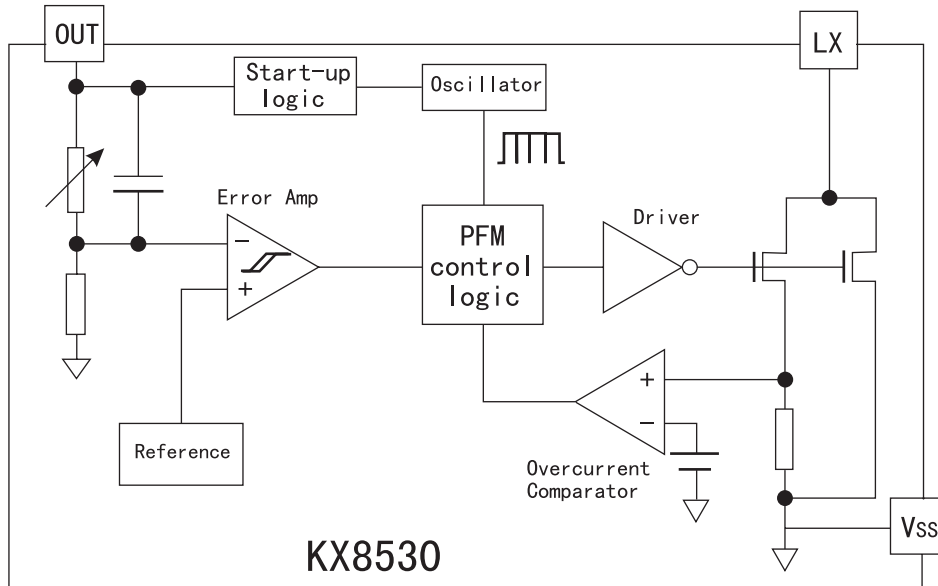

■ Absolute Maximum Ratings

Input voltage range	-----	0.3V~12V
Input voltage: $V_i(LX)$	-----	0.3V~($V_{out}+0.3$)
CE pin voltage	-----	0.3V~($V_{out}+0.3$)
Lx pin output current	-----	0.7A
Maximum power dissipation, P_d $T=25^{\circ}C$		
SOT-89	-----	0.5W
SOT-153	-----	0.15W
SOT-23	-----	0.15W
Maximum junction temperature	-----	150 $^{\circ}C$
Operating free-air temperature range	-----	-20~+80 $^{\circ}C$
Storage temperature range	-----	-40~125 $^{\circ}C$
Lead temperature and time	-----	260 $^{\circ}C$, 10S

■ Recommended Operating Conditions

Parameter	Min	Nom	Max	Unit
Input voltage range	0.8		V_{out}	V
Inductor	10	27	100	μH
Input capacitor	0	≥ 10		μF
Output capacitor	47	100	220	μF
Operating junction temperature	-20		85	$^{\circ}C$

KX8530

■ Electrical Characteristics Ta = 25°C

Parameter	Symbol	Testconditons	Min	Typ	Max	Unit
Output Voltage	V _{out}		2.45	2.5	2.55	V
			2.646	2.7	2.754	
			2.94	3.0	3.06	
			3.234	3.3	3.366	
			3.528	3.6	3.672	
			3.92	4.0	4.08	
			4.9	5.0	5.1	
			5.88	6.0	6.12	
Input Voltage	V _{in}				12	V
Input Current	I _{in}	I _{out} =0mA, V _{in} =V _{out} *0.6		12	15	uA
Start-up voltage	V _{start}	I _{out} =1mA, V _{in} : 0→2V		0.8	0.9	V
Hold-on voltage	V _{hold}	I _{out} =1mA, V _{in} : 2→0V	0.6	0.7		V
Quiescent current drawn from power source	I _{DD}	Without external		4	7	uA
		components, V _{out}				
		=V _{out} *1.05				
Switch ON Resistance	R _{swon}			0.4	0.5	Ω
LX leakage current	I _{LXleak}	V _{out} =V _{LX} =6V			0.5	uA
CE "H" threshold voltage	V _{CEH}	V _{CE} : 0→2V	0.6	0.9		V
CE "L" threshold voltage	V _{CEL}	V _{CE} : 2→0V		0.3	0.6	V
Oscillator frequency	F _{osc}	LX on "L" side V _{out} =V _{out} *0.96	300	350	400	Khz
Oscillator duty cycle	Maxdty	On (V _{LX} "L" side)	70	75	80	%
Efficiency	η			85		%

Note

1. Diode: Schottky type, such as :1N5817, 1N5819, 1N5822
2. Inductor: 27uH(R<0.5Ω)
3. Capacitor: 100uF(Tantalum type)

■ Test Circuits

(1) Output voltage test circuit (I_{load} = 1mA)

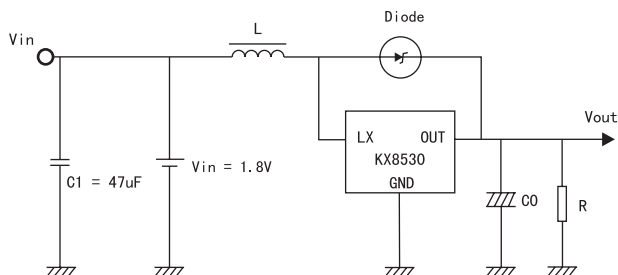

KX8530

(2) Start-up voltage test circuit ($I_{load} = 1mA$)

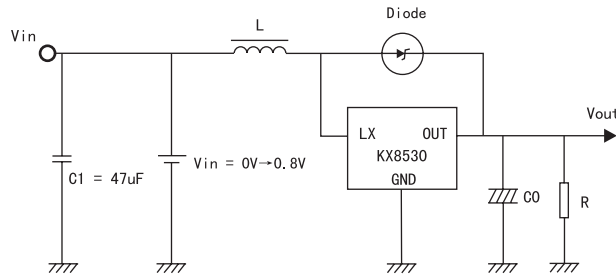

(3) Hold-on voltage test circuit ($I_{load} = 1mA$)

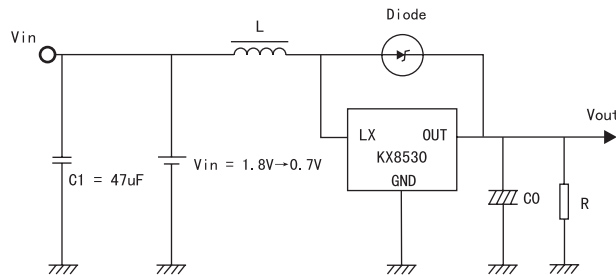

(4) Quiescent current test circuit

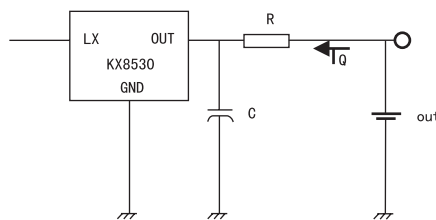

$V_{out} = V_{out} * 1.05, R = 1K\Omega, C = 0.1\mu F$

(5) Oscillator frequency and duty cycle test circuit

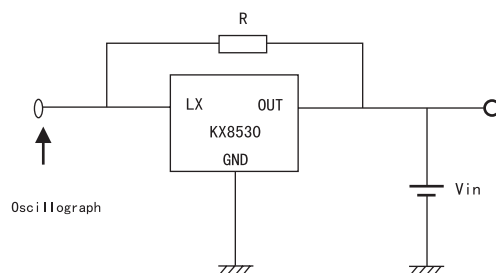

$V_{in} = V_{out} * 0.95, R = 1K\Omega$

KX8530

Typical Characteristic

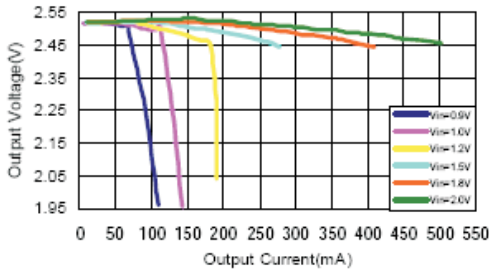

KX8530-251SM Output Voltage VS. Output Current

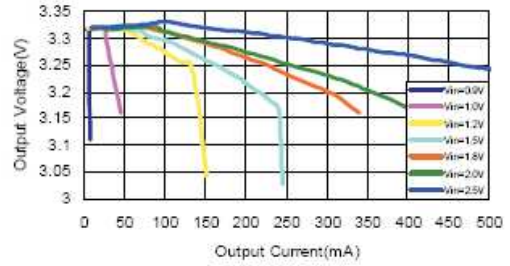

KX8530-331sm Output Voltage VS. Output Current

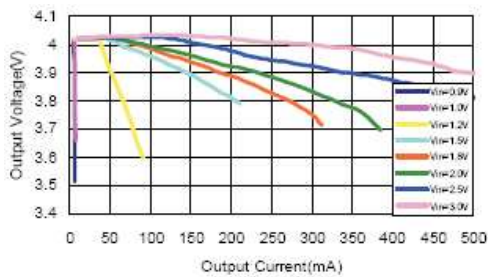

KX8530-401SM Output Voltage VS. Output Current

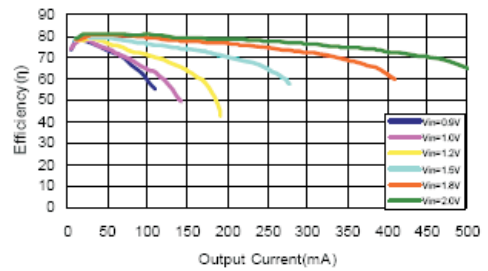

KX8530-251SM Efficiency VS. Output Current

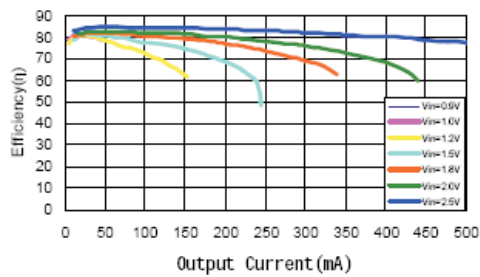

KX8530-331SM Efficiency VS. Output Current

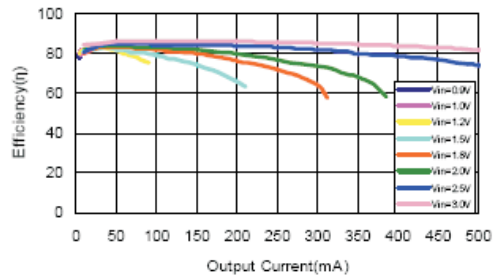

KX8530-401SM Efficiency VS. Output Current

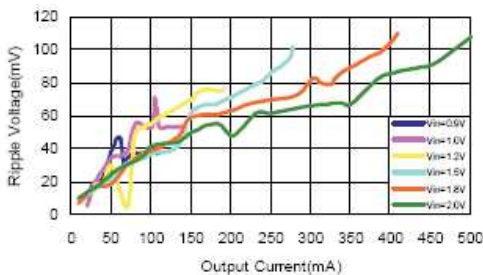

KX8530-251SM Ripple Voltage VS. Output Current

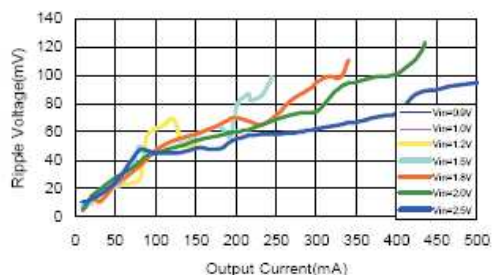

KX8530-331SM Ripple Voltage VS. Output Current

KX8530

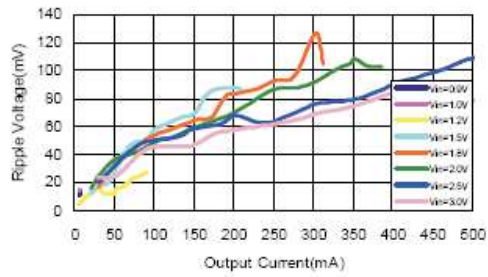

KX8530-401SM Ripple Voltage VS. Output Current

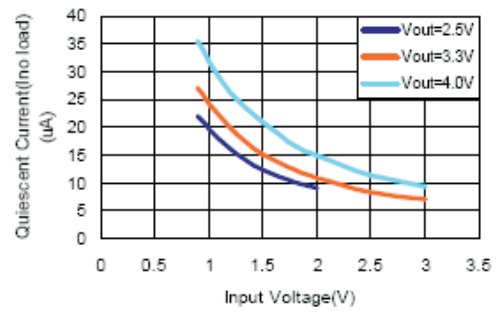
KX8530 Quiescent Current (I_q) VS. Input Voltage