

200mW Surface Mount Zener Diode MMBZ5243BW

Features

- Planar Die Construction
- General Purpose, Medium Current
- Ideally Suited for Automated Assembly Processes

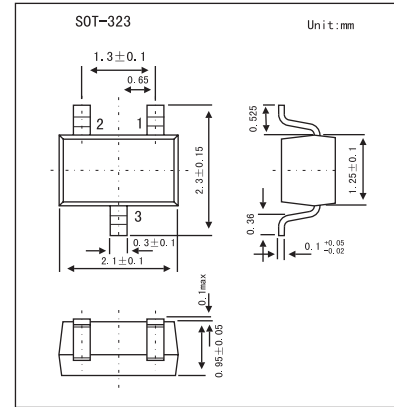
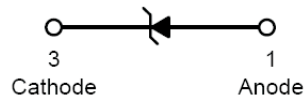

Absolute Maximum Ratings $T_a = 25^\circ\text{C}$

Parameter	Symbol	Rating	Unit
Forward Voltage @ $I_F = 10\text{mA}$	V_F	0.9	V
Power Dissipation *1	P_d	200	mW
Thermal Resistance, Junction to Ambient Air *1	$R_{\theta JA}$	625	$^\circ\text{C/W}$
Operating and Storage Temperature Range	T_j, T_{STG}	-65 to +150	$^\circ\text{C}$

*1. Part mounted on FR-4 PC board with recommended pad layout

Electrical Characteristics @ $T_A=25^\circ\text{C}$ unless otherwise specified

Type Number	Zener Voltage Range *1				Maximum Zener Impedance *2		Maximum Reverse Leakage Current *1	
	$V_Z @ I_{ZT}$			I_{ZT}	$Z_{ZT} @ I_{ZT}$	$Z_{ZK} @ I_{ZK} = 0.25\text{mA}$	I_R	@ V_R
	Nom (V)	Min (V)	Max (V)	mA	Ω		μA	V
MMBZ5243BW	13	12.35	13.65	9.5	13	600	0.5	9.9

*1. Short duration test pulse used to minimize self-heating effect.

*2. $f = 1\text{kHz}$.

Marking

Marking	KH3
---------	-----

MMBZ5243BW

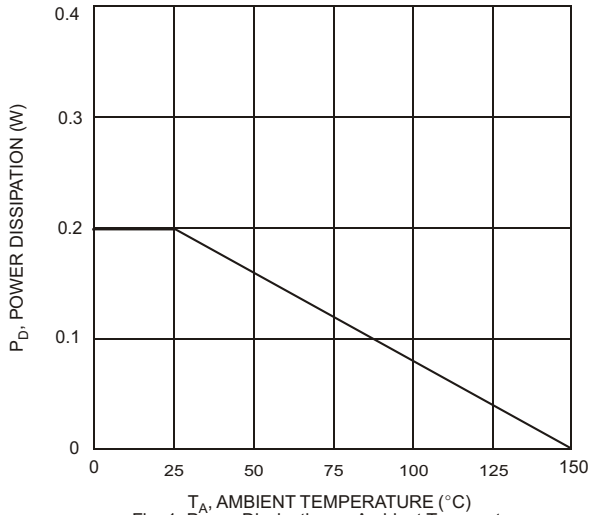

Fig. 1 Power Dissipation vs Ambient Temperature

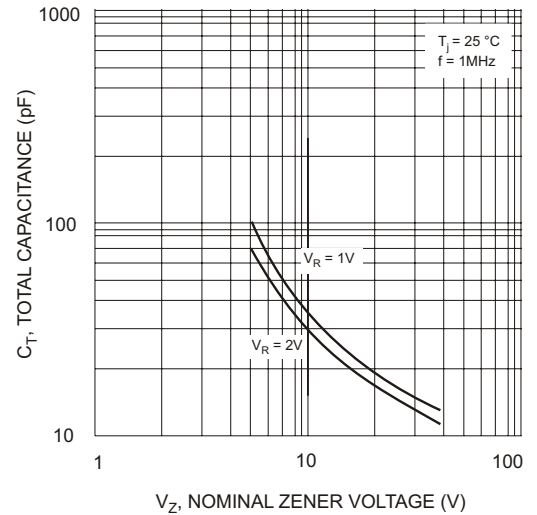

Fig. 2 Total Capacitance vs Nominal Zener Voltage

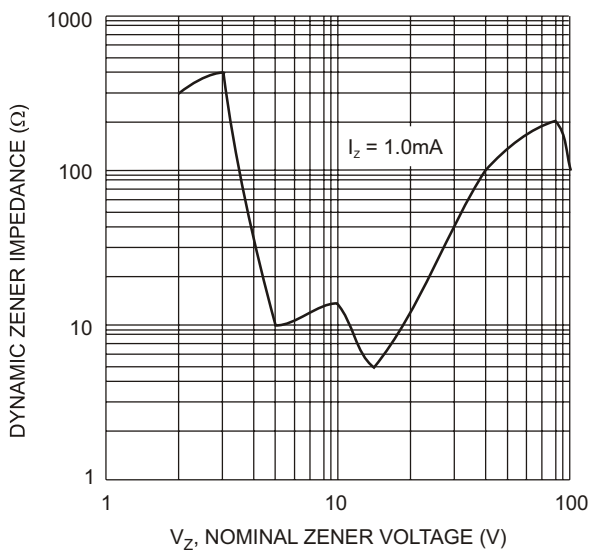

Fig. 3 Zener Voltage vs. Zener Impedance

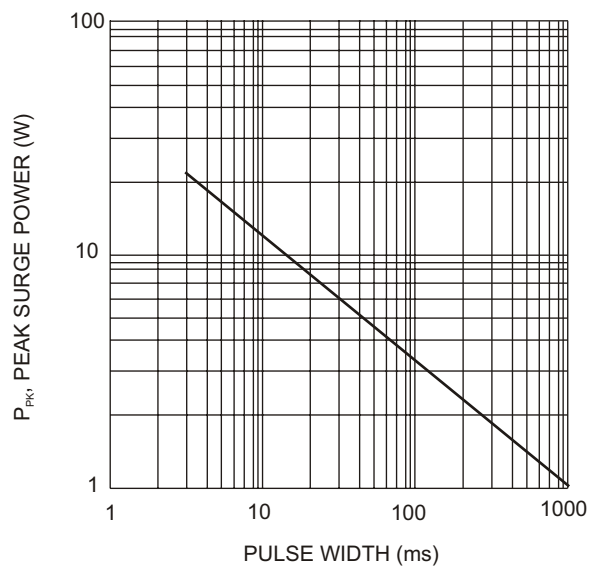

Fig. 4 Maximum Non-repetitive Surge Power

MMBZ5243BW

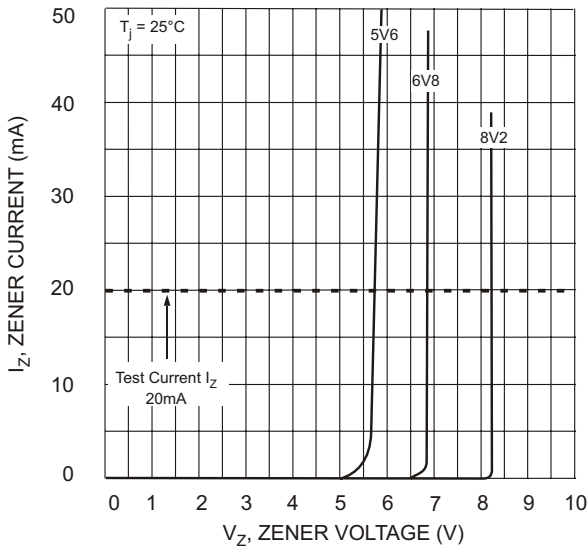

Fig. 5 Zener Breakdown Characteristics

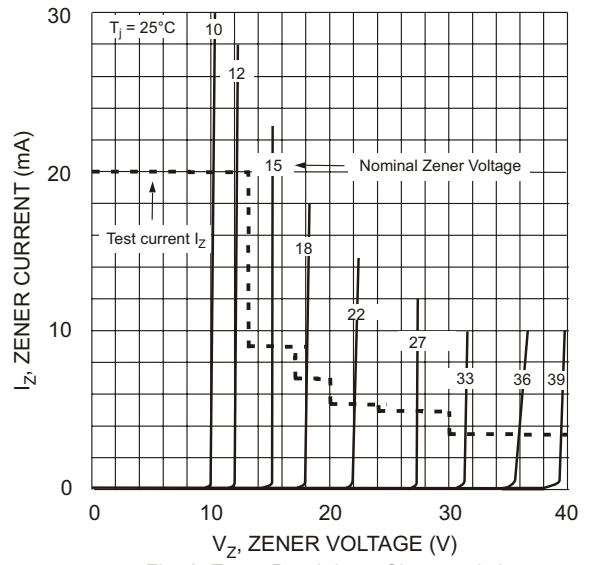

Fig. 6 Zener Breakdown Characteristics