

## Surface Mount Zener Diode

### MM3Z20VS

#### Features

Planar Die Construction

Ultra-Small Surface Mount Package

Ideally Suited for Automated Assembly Processes

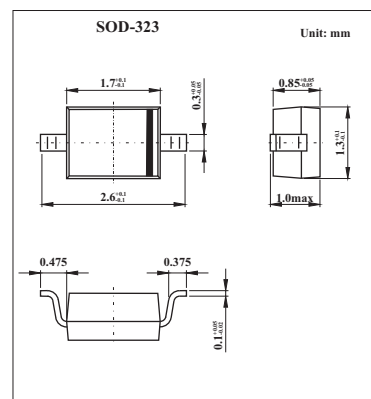

#### Absolute Maximum Ratings $T_a = 25^\circ\text{C}$

Parameter	Symbol	Rating	Unit
Power Dissipation (Note 1)	$P_D$	200	mW
Forward Voltage @ $I_F = 10\text{mA}$	$V_F$	0.9	V
Thermal Resistance, Junction to Ambient Air (Note 1)	$R_{\theta JA}$	625	$^\circ\text{C}/\text{W}$
Operating and Storage Temperature Range	$T_J, T_{STG}$	-65 to +150	$^\circ\text{C}$

Note: 1. Part mounted on FR-4 PC board with recommended pad layout.

#### Electrical Characteristics @ $T_a = 25^\circ\text{C}$ unless otherwise specified

Type Number	Zener Voltage Range (Note 2)			Maximum Zener Impedance (Note 3)			Maximum Reverse Current (Note 2)		Typical Temperature Coefficient @ $I_{ZT}$ $\text{mV}/^\circ\text{C}$		
	$V_Z @ I_{ZT}$			$Z_{ZT} @ I_{ZT}$	$Z_{ZK} @ I_{ZK}$	$I_{ZK}$	$I_R @ V_R$				
	Min (V)	Nom (V)	Max (V)	mA	$\Omega$	mA	$\mu\text{A}$	V	Min	Max	
MM3Z20VS	18.8	20	21.2	5	55	100	0.5	0.05	14	14.4	18

Notes: 2. Short duration test pulse used to minimize self-heating effect.

3.  $f = 1\text{kHz}$ .

#### Marking

Marking	2K
---------	----

# MM3Z20VS

## ■ Typical Characteristics

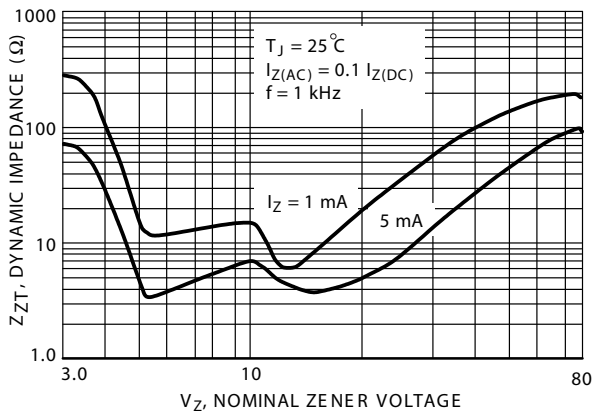

Fig.1 Effect of Zener Voltage on Zener Impedance

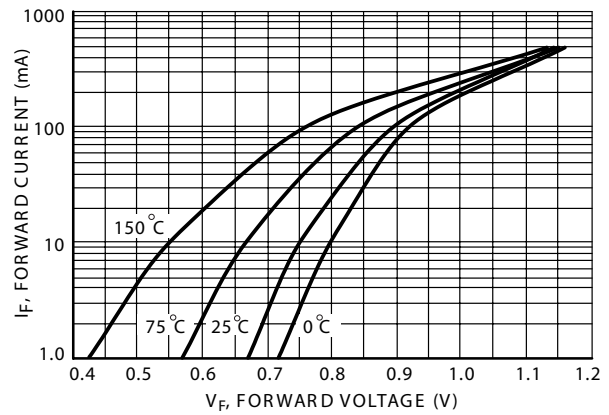

Fig.2 Typical Forward Voltage

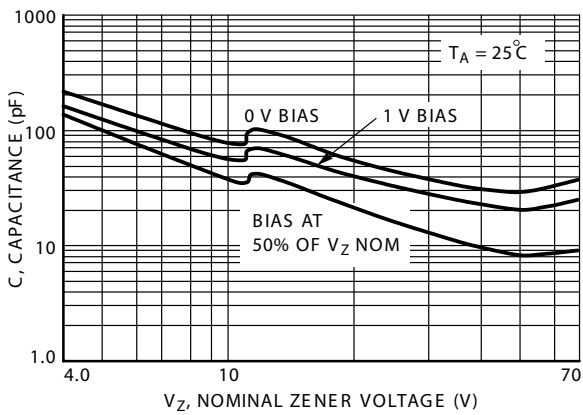

Fig.3 Typical Capacitance

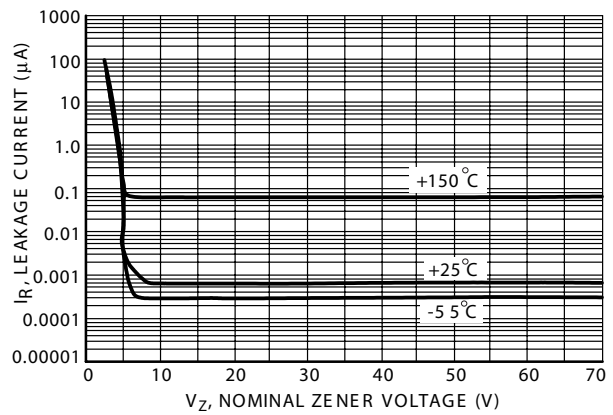

Fig.4 Typical Leakage Current

### MM3Z20VS

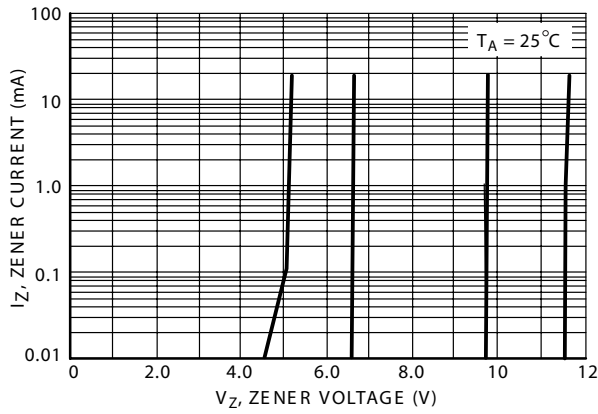

Fig.5 Zener Voltage versus Zener Current  
(V<sub>Z</sub> Up to 12 V)

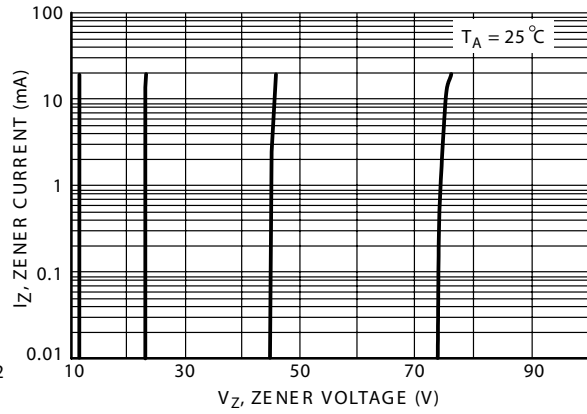

Fig.6 Zener Voltage versus Zener Current  
(12 V to 75 V)

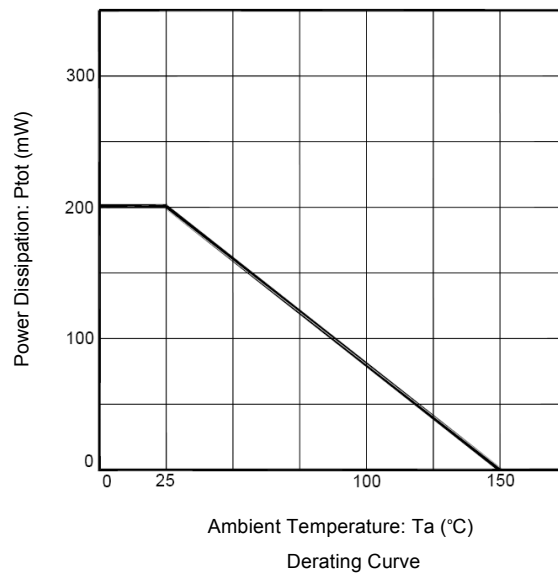

Fig.7 Power Dissipation VS Ambient Temperature