

Surface Mount Zener Diode

MM3Z13VS

Features

Planar Die Construction

Ultra-Small Surface Mount Package

Ideally Suited for Automated Assembly Processes

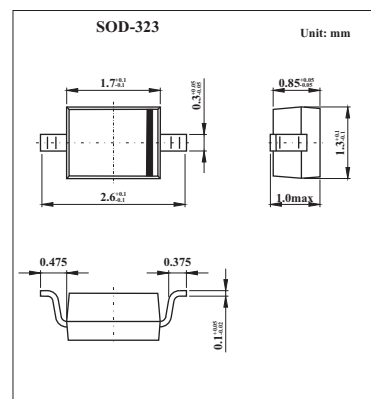
Absolute Maximum Ratings $T_a = 25^\circ\text{C}$

Parameter	Symbol	Rating	Unit
Power Dissipation (Note 1)	P_D	200	mW
Forward Voltage @ $I_F = 10\text{mA}$	V_F	0.9	V
Thermal Resistance, Junction to Ambient Air (Note 1)	$R_{\theta JA}$	625	$^\circ\text{C}/\text{W}$
Operating and Storage Temperature Range	T_j, T_{STG}	-65 to +150	$^\circ\text{C}$

Note: 1.Part mounted on FR-4 PC board with recommended pad layout.

Electrical Characteristics @ $T_a=25^\circ\text{C}$ unless otherwise specified

Type Number	Zener Voltage Range (Note 2)				Maximum Zener Impedance (Note 3)			Maximum Reverse Current (Note 2)		Typical Temperature Coefficient @ I_{ZT} $\text{mV}/^\circ\text{C}$	
	$V_Z @ I_{ZT}$			I_{ZT}	$Z_{ZT} @ I_{ZT}$	$Z_{ZK} @ I_{ZK}$	I_{ZK}	$I_R @ V_R$		Min	Max
	Min (V)	Nom (V)	Max (V)	mA	Ω	mA	μA	V			
MM3Z13VS	12.4	13	14.1	5	30	80	0.5	0.1	8	7	11

Notes: 2. Short duration test pulse used to minimize self-heating effect.

3. $f = 1\text{kHz}$.

Marking

Marking	2E
---------	----

MM3Z13VS

■ Typical Characteristics

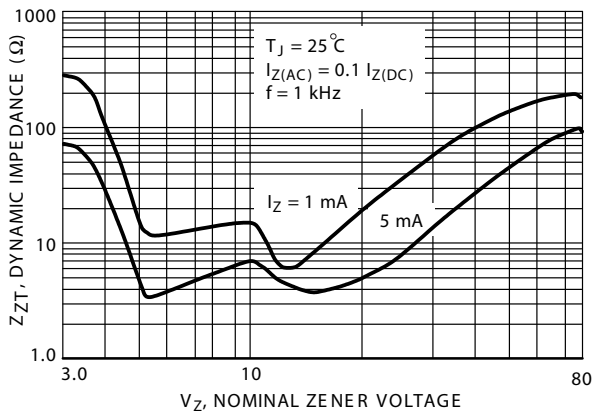

Fig.1 Effect of Zener Voltage on Zener Impedance

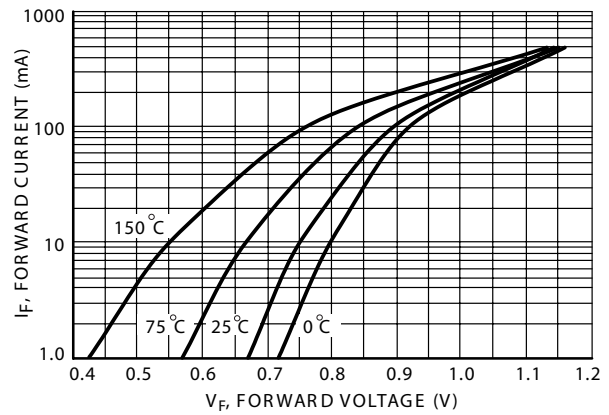

Fig.2 Typical Forward Voltage

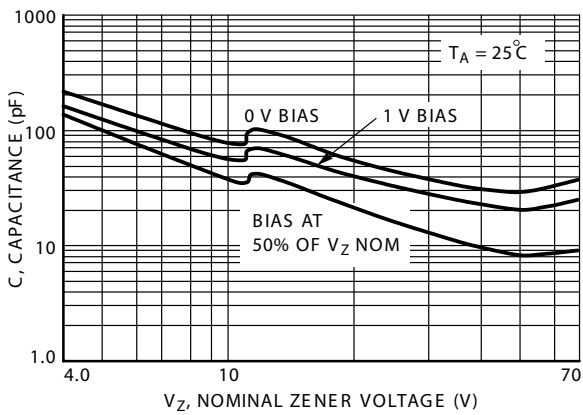

Fig.3 Typical Capacitance

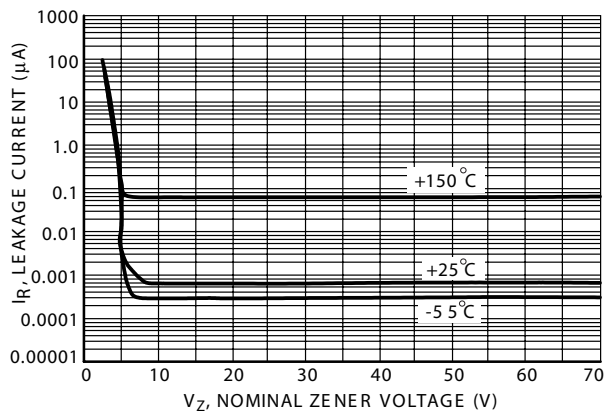

Fig.4 Typical Leakage Current

MM3Z13VS

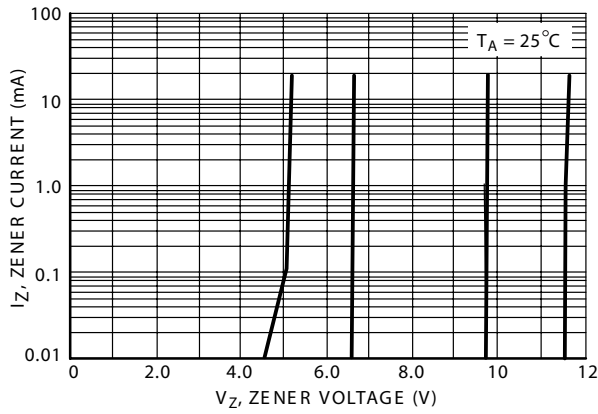

Fig.5 Zener Voltage versus Zener Current
(V_Z Up to 12 V)

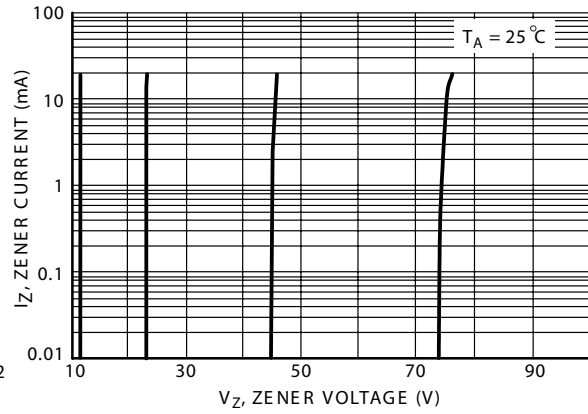

Fig.6 Zener Voltage versus Zener Current
(12 V to 75 V)

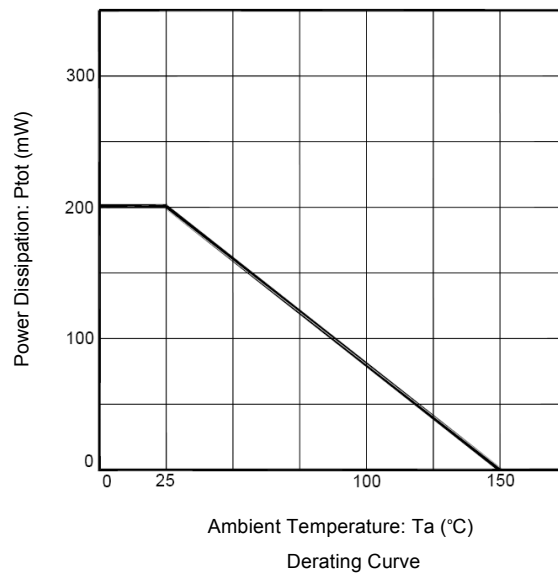

Fig.7 Power Dissipation VS Ambient Temperature