

Surface Mount Zener Diode

BZT55C39

Features

500mW Power Dissipation

Low reverse current level

Very high stability

Low noise

Ideal for Surface Mounted Application

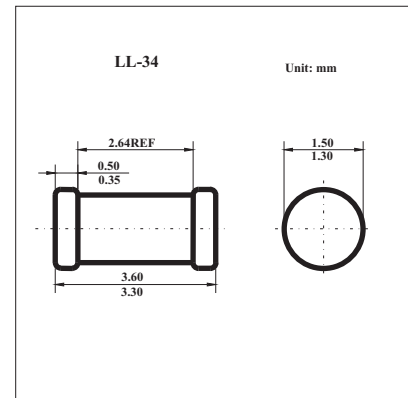
Absolute Maximum Ratings $T_a = 25^\circ\text{C}$

| Parameter | Symbol | Rating | Unit |
|--|-----------------|-------------|---------------------------|
| Power Dissipation (Note 1) | P_D | 500 | mW |
| Forward Voltage @ $I_F = 200\text{mA}$ | V_F | 1.5 | V |
| Thermal Resistance, Junction to Ambient Air (Note 1) | $R_{\theta JA}$ | 300 | $^\circ\text{C}/\text{W}$ |
| Operating and Storage Temperature Range | T_j, T_{STG} | -65 to +175 | $^\circ\text{C}$ |

Notes: 1. Valid provided that electrodes are kept at ambient temperature.

Electrical Characteristics $T_a = 25^\circ\text{C}$

| Type | Zener Voltage Range (Note 2) | | | | Maximum Zener Impedance | | | Maximum Reverse Current | |
|----------|------------------------------|---------|---------|----------|-------------------------|-------------------|----------|-------------------------|----|
| | $V_Z @ I_{ZT}$ | | | I_{ZT} | $Z_{ZT} @ I_{ZT}$ | $Z_{ZK} @ I_{ZK}$ | I_{ZK} | $I_R @ V_R$ | |
| | Nom (V) | Min (V) | Max (V) | mA | Ω | Ω | mA | μA | V |
| BZT55C39 | 39 | 37 | 41 | 2.5 | 90 | 500 | 0.5 | 0.1 | 30 |

Notes: 2. Tested with pulses, $T_p = 100\text{ms}$.

BZT55C39

■ Typical Characteristics

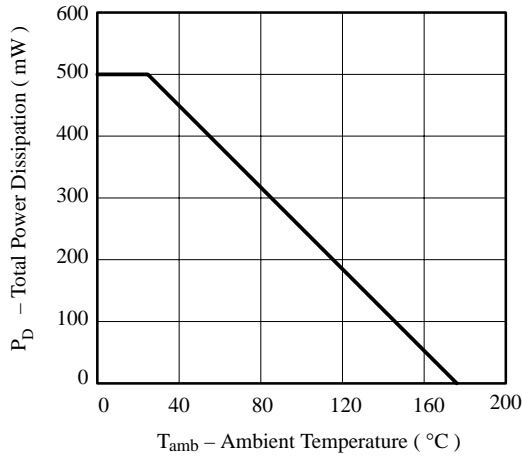

Figure 1. Total Power Dissipation vs. Ambient Temperature



Figure 2. Typical Change of Working Voltage vs. Junction Temperature



Figure 3. Typical Change of Working Voltage under Operating Conditions at $T_{amb}=25^{\circ}C$



Figure 4. Temperature Coefficient of V_Z vs. Z-Voltage



Figure 5. Diode Capacitance vs. Z-Voltage

BZT55C39

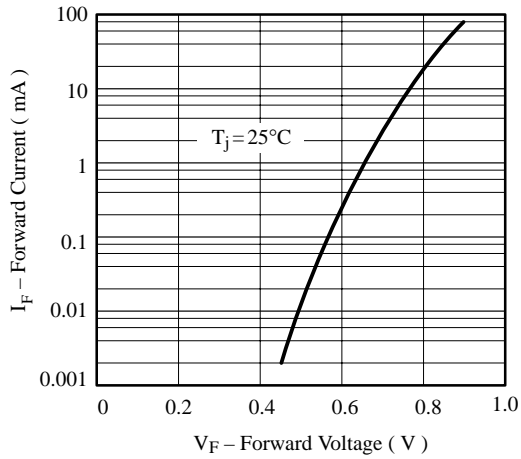

Figure 6. Forward Current vs. Forward Voltage

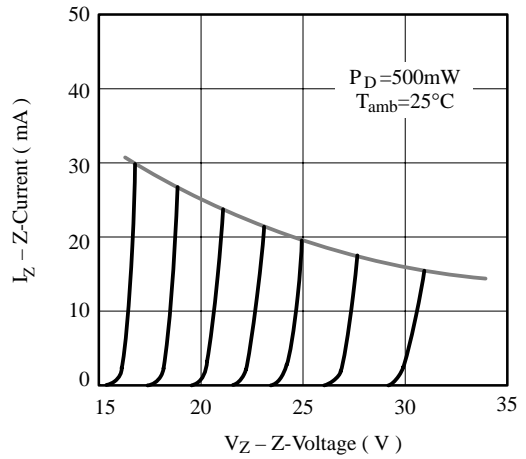

Figure 7. Z-Current vs. Z-Voltage

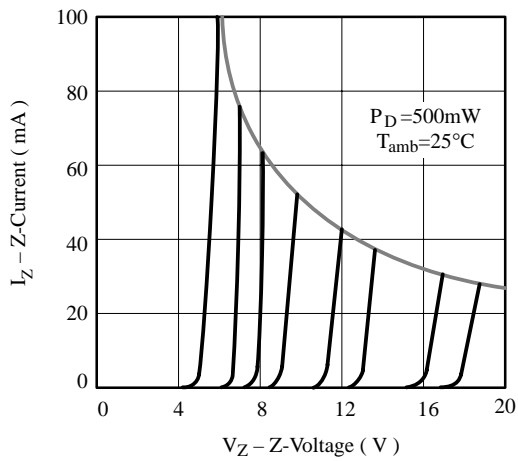

Figure 8. Z-Current vs. Z-Voltage

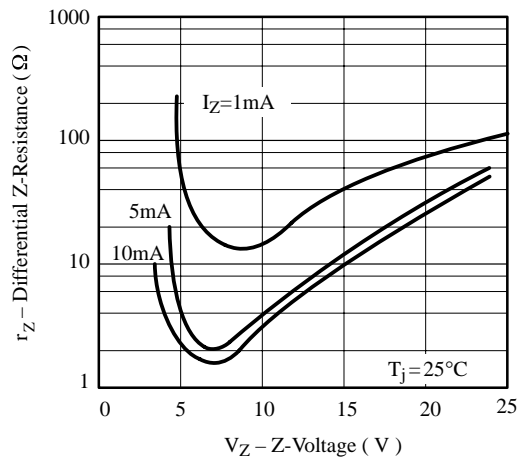

Figure 9. Differential Z-Resistance vs. Z-Voltage

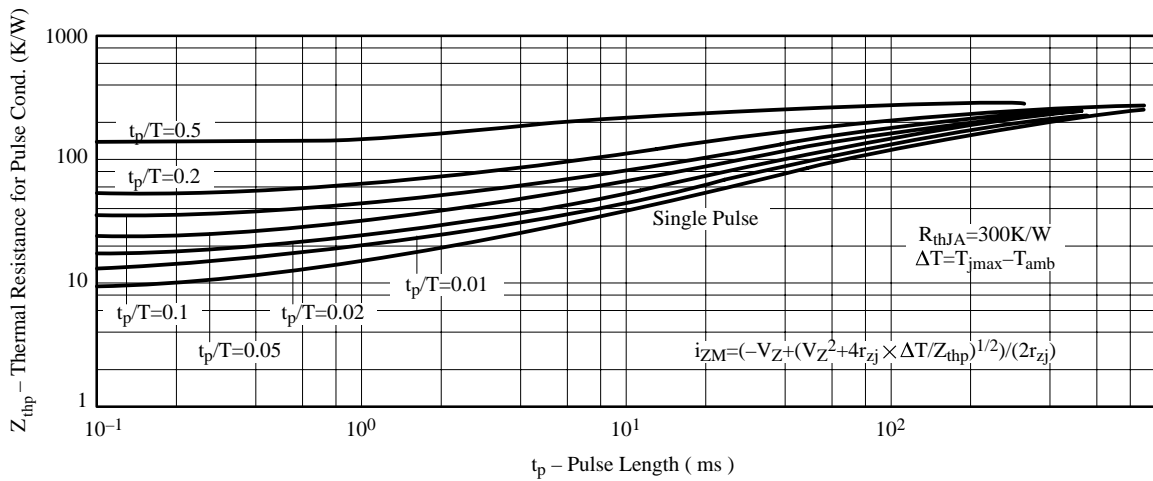

Figure 10. Thermal Response