

## Features:

- Frequency Range: 3.4 to 3.7 GHz
- 13.0 dB Gain
- 36.5 dBm P1dB
- 48 dBm IP3
- 29.5 dBm Pout @ 2% EVM
- Power Detector
- Power Control
- Single Positive Power Supply
- Pre-match for Easy Cascade
- RoHS-Compliant Surface Mount Package

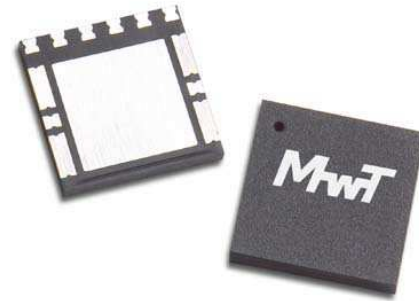

## Applications:

- 802.16 WiMax
- 802.11 WLAN
- Wireless Communications
- Telecomm Infrastructure

## Description:

The MMA-343737-Q10 is a 4 watt amplifier pre-matched to 50 ohm operating over frequency range of 3.4 GHz to 3.7 GHz. The RF gain is 13 dB. The typical output IP3 is 48 dBm and P1dB is 36.5 dBm. The MMA-343737-Q10 amplifier has excellent performance as power amplifiers in 802.11 WLAN and 802.16 WiMax applications. At 2.0% error vector magnitude (EVM), the amplifier can achieve an average output power of 29.5 dBm. The MMA-343737-Q10 is packaged in a quad flat no-lead (QFN) with a copper base paddle providing high thermal conductance, low lead inductance, small size, near-chip-scale footprint and thin profile. The package construction is RoHS compliant. It includes a detector. There is a voltage converter for gate bias.

## Typical RF Performance: *Vdd2=8.5V, Vdd1=5.0V, Ta=25 °C, Z0=50 ohm*

Parameter	Units	Min	Typical	Max
Frequency Range	GHz	3.4		3.7
Small Signal Gain	dB	12	13	
Input/Output VSWR	N/A		2.0:1/3.6	
Pout at 1dB Compression Point	dBm		+36.5	
Burst Power Average @ 2% EVM (1)	dBm	29.0	29.5	
Output Third Order Intercept (2)	dBm		48	
DC Current (3)	mA		1000	
Voltage Power Control (4)	Volt		5.0	
RF Detector Output Range	Volt	0.1		2.0
Thermal Resistance Junction to Case	°C/W		6	

(1) The test signal is 802.16, 256 carriers, 64 QAM, 10 msec frame length. The measured EVM includes the accumulated errors (0.9%) from the modulator and driver stages.

(2) The output power per tone is 25 dBm and the tone separation is 20 MHz center at 3.5 GHz.

(3) The idle current Idq can be adjusted from 0 mA to 1.0 A.

(4) The power control voltage requires a series resistor to de-sensitize the rate of change Idq current with Vpc. Recommended values of Rext vary from 500 Ω to 2.2K Ω. The voltage range for Vpc from 0 to 2.5 volts.

## Typical RF Performance: $V_{dd1}=V_{dd2}=8.5V$ , $R_{ext}=560\Omega$ , $V_{pc}=5.0V$

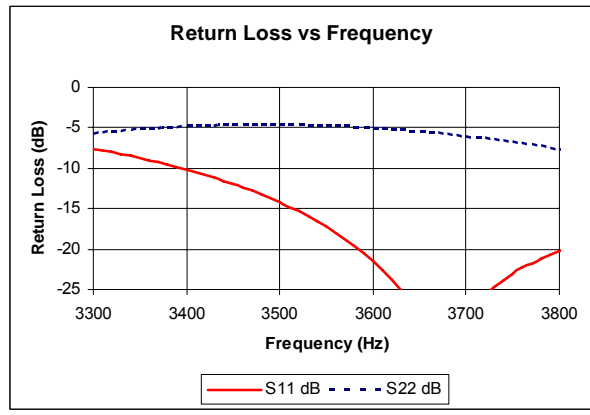
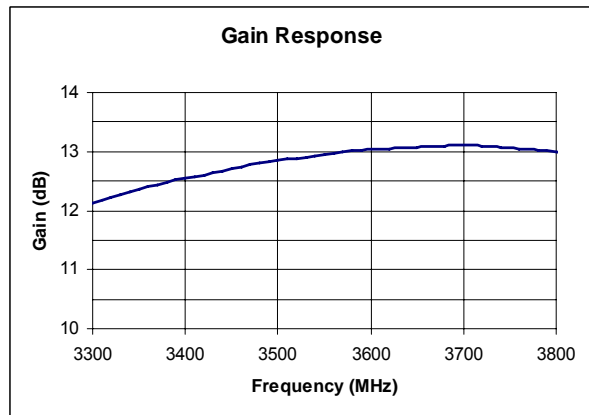
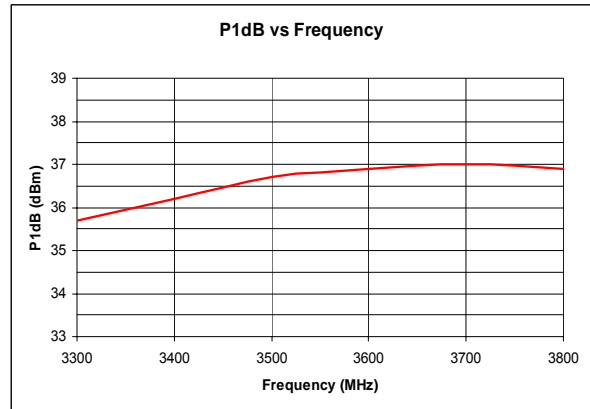
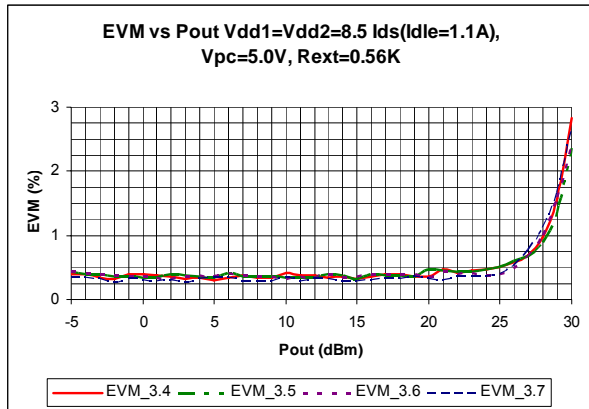

## Absolute Maximum Ratings: $(T_a = 25\text{ }^\circ\text{C})^*$

PARAMETERS	UNITS	ABSOLUTE MAXIMUM
Bias Voltage	V	10.0
I <sub>dd</sub>	A	1.7
Continuous RF Input Power	dBm	+33
Peak Input Power	dBm	+36
Case Operating Temperature	°C	+70

\*Operation of this device above any one of these parameters may cause permanent damage.

## Typical Scattering Parameters: $V_{dd1}=V_{dd2}=8.5V, R_{ext}=560\Omega, V_{pc}=5.0V, I_{dq}=1.0A^{**}$

Freq (GHz)	S11		S21		S12		S22	
	MAG	ANG	MAG	ANG	MAG	ANG	MAG	ANG
3.0	0.65	119.71	3.43	21.94	0.042	-54.99	0.26	-168.38
3.1	0.59	106.96	3.51	0.537	0.045	-76.92	0.34	-179.84
3.2	0.51	87.862	3.779	-28.772	0.050	-106.25	0.44	165.25
3.3	0.41	68.15	4.036	-58.958	0.056	-136.25	0.52	149.10
3.4	0.31	48.33	4.24	-89.69	0.062	-166.7	0.57	132.76
3.5	0.19	29.49	4.39	-120.76	0.067	162.48	0.58	116.72
3.6	0.08	19.14	4.487	-152.37	0.072	131.29	0.56	100.71
3.7	0.04	91.36	4.521	175.27	0.075	99.561	0.50	84.12
3.8	0.09	97.27	4.47	141.75	0.077	66.92	0.42	65.98
3.9	0.12	64.12	4.29	106.86	0.077	33.00	0.31	44.35
4.0	0.10	7.21	3.967	70.811	0.073	-1.84	0.20	14.42
4.1	0.13	-79.48	3.50	33.94	0.066	-37.09	0.11	-47.28
4.2	0.24	-141.43	2.92	-2.76	0.056	-71.79	0.17	-126.99
4.3	0.39	177.24	2.31	-38.17	0.044	-104.97	0.30	-162.87
4.4	0.53	144.22	1.75	-71.04	0.033	-135.23	0.42	175.76
4.5	0.63	116.34	1.28	-100.1	0.023	-161.84	0.51	160.27
4.6	0.70	92.16	0.94	-125.41	0.016	175.7	0.57	148.01
4.7	0.75	70.56	0.70	-147.93	0.010	156.98	0.62	137.47
4.8	0.79	50.77	0.53	-168.2	0.006	142.57	0.66	127.76
4.9	0.82	32.40	0.40	172.42	0.003	133.68	0.69	118.60
5.0	0.84	19.92	0.34	157.00	0.002	131.41	0.71	112.40

**\*\*S-parameters are measured in MwT's evaluation fixture.**

### Package Outline Diagram (QFN10)

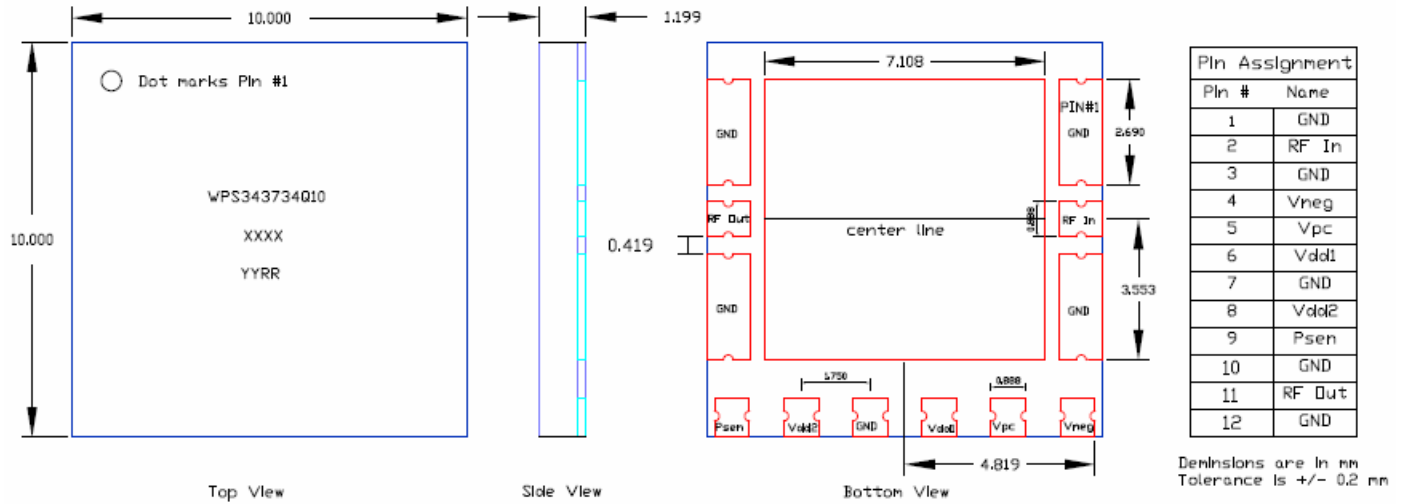

**All dimensions are in mm**

## Application Note

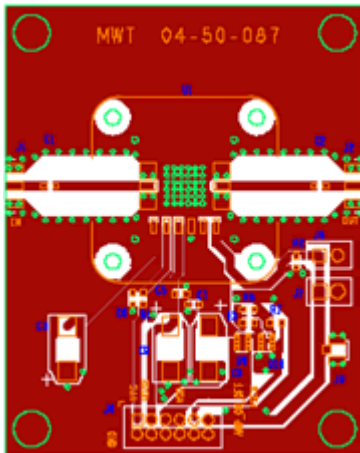

**Figure 1 Evaluation Board**

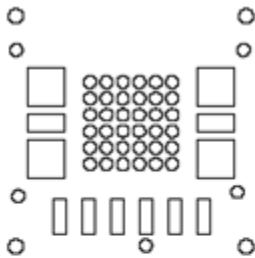

**Figure 2 Hole Pattern**

The via hole design, shown in Figure 2, uses a 6x6 via hole array; the finished via hole diameter is 25 mils. The pitch between holes is 38 mils. The simulated thermal impedance is less than 0.6°C/W. The PCB finish is nickel over copper with a gold flash.

Please consult our factory to request s-parameters, Gerber file and samples.

A functional diagram is shown in Figure 3. The MMA-343737-Q10 amplifier includes bias tees for DC inputs at QFN Vdd1 pin 6 and Vdd2 pin 8. In addition, the MMA-343737-Q10 has its own DC blocking capacitors. The breakdown voltage for the blocking capacitor is 30 VDC.

The measurements presented are recorded at  $V_{dd}=8.5$  and  $I_{dq}=1.0$  A. The evaluation board layout shown in Figure 1 is a double side printed circuit board; the board material is Rogers' 4003; the board thickness is 20 mils; the dielectric constant is 3.38; and the copper trace weight is 1 oz. The trace width for 50 ohm from J1 and J2 is 44 mils. A double row of stitch through holes, 25 mil diameters, define the ground boundaries for the coplanar waveguide RF launch for J1 and J2. The RF launch at QFN pin 2 and pin 11 are designed to match into 50 ohms so that all stray capacitances and inductances at the interface has been minimized. The MMA-343737-Q10 is matched to 50 ohms.

The QFN leads and center paddle sits lower than the thermo-set plastic material used for the QFN body. There are 12 contact leads flushed to the edge of the QFN package which allows for visual inspection of solder joints. Six ground contacts are provided; two pairs of grounds pads for each RF; two other grounds, pin 7 and the center paddle. The other 7 contacts are for voltage supplies and RF/video signals. The QFN package is a 10 x10 x 1.5 mm and the finish is nickel 200  $\mu$ m palladium 20  $\mu$ m flash gold finish 6-10  $\mu$ m. The base material for the QFN is copper and its thickness is 8 mils. The connector J4 shown in Figure 1 is a 12 pin double row header used to bring power and signals to QFN amplifier.

The power detector circuitry includes an optional low pass filter on the evaluation board which can be used to create a DC average of the RF envelope. The unfiltered detector bandwidth is approximately 50 MHz.

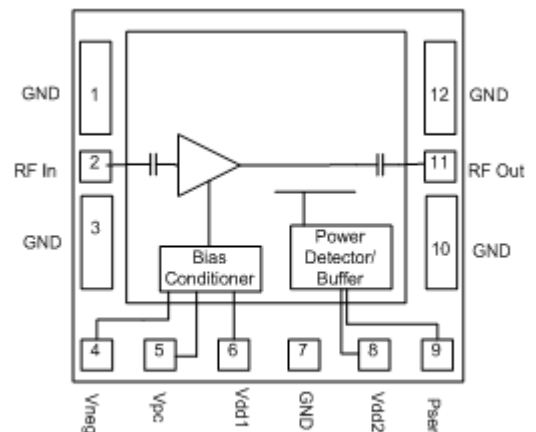
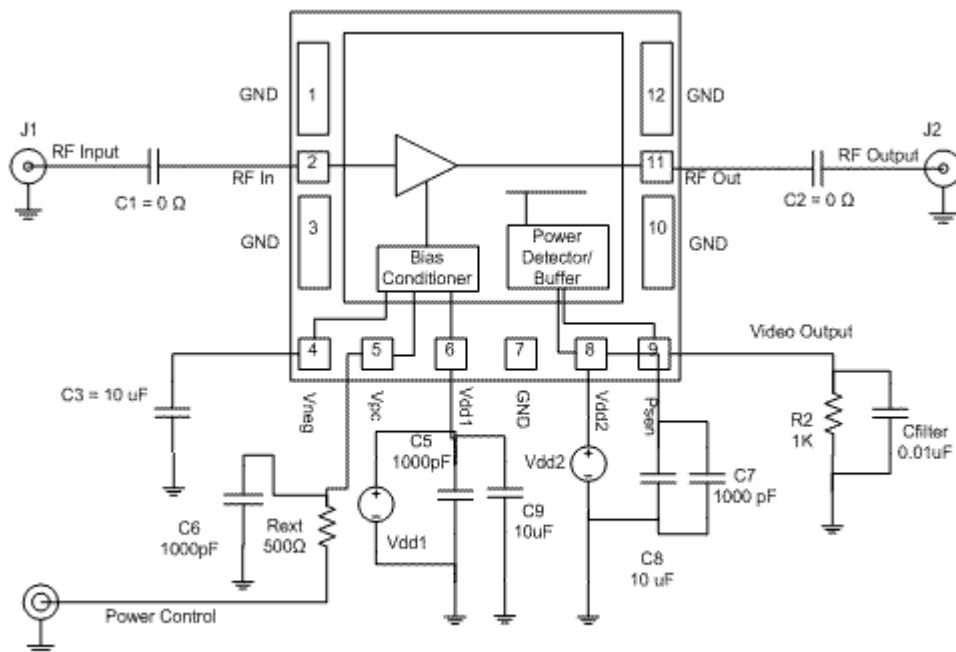

**Figure 3 Block Diagram**

## Application Note (continued)

The evaluation board schematic is shown in Figure 4. The bias conditioner circuit requires a 10uF capacitor on QFN pin 4 to maintain DC stability. The bias input, Vdd1 at QFN pin 6 is used to supply power to the bias conditioner and the bias input Vdd2 at QFN pin 8 is used to supply power for both the RF amplifier and power detector circuitry.

The bias conditioner circuit must be powered up before RF amplifier. Applying a DC voltage to Vpc, QFN pin 5, controls the DC bias current of the RF amplifier. Zero volts or no connection will pinch off the RF amplifier. Increasing the voltage to Vpc will increase the idle current. The suggested idle current is 1.0A without RF. This setting will operate the RF amplifier in a class A/B operation. Other settings can be used. The maximum current shall not exceed 1.3 A. These conditions can vary depending upon the setting of Vdd2.



**Figure 4 Evaluation Board Schematic**

The output voltage at QFN pin 4, Vneg is -2.0 volts. A maximum of 1 mA is allowed to be pulled from this signal. Smaller values than 10uF may cause instability to bias conditioner.

Two 10uF capacitors are used for bypassing Vdd1 and Vdd2. Power sequencing is required when Vdd1 and Vdd2 are separated. No sequencing is required when Vdd1 and Vdd2 are connected to the same power supply. The minimal allowed voltage is 5.5 volts on Vdd1 and Vdd2.

The amplifier's noise figure shown in Figure 5 is less than 8.0 dB and varies less than +/- 0.3 for different values of Vpc from 2.0 to 5.5 volts. The supply current versus output power and P1dB versus frequency is shown Figures 6 and 7. The P1dB is 36 dBm at 80°C. The Ids current is 1.6A at the P1dB. The two tone linearity is very stable across the frequency range as shown in Figure 8. The power per tone is 25 dBm and frequency separation is 20 MHz. The IMD3 level is -47 dBc. A plot of average power at EVM=2% versus different Vpc voltage values is shown in Figure 9. The Vpc shut down feature is available upon request.

## Application Note (continued)

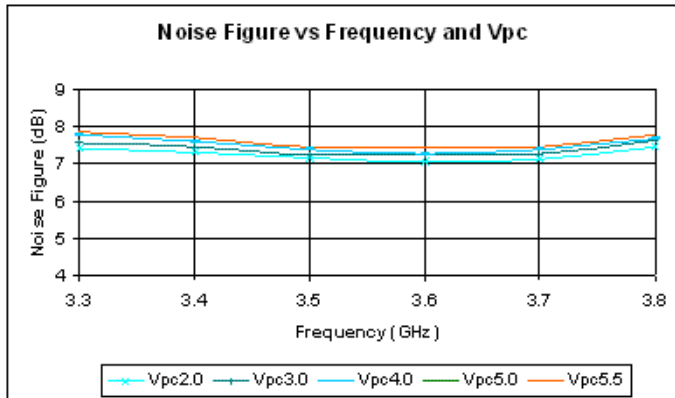

Figure 5 Noise Figure

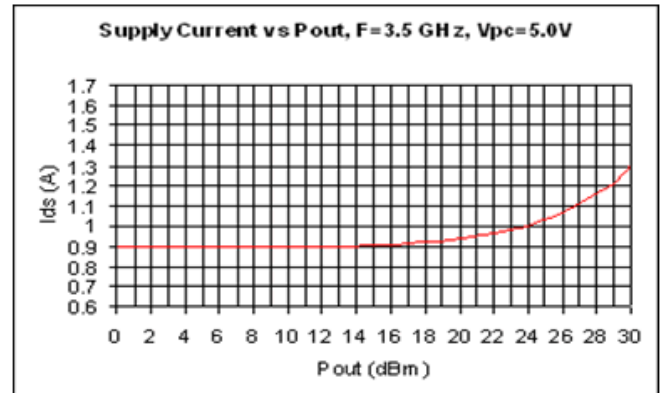

Figure 6 Supply Current

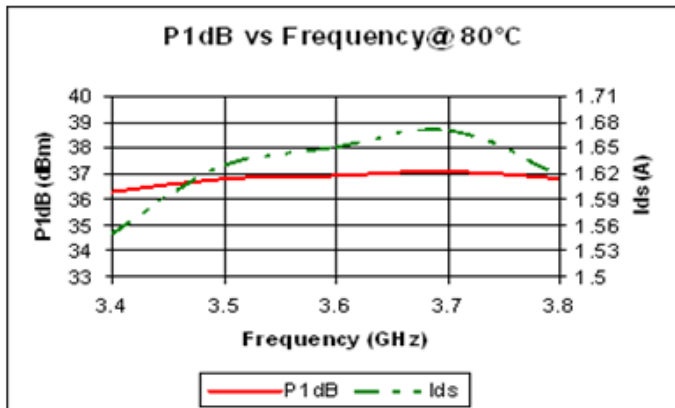

Figure 7 P1dB

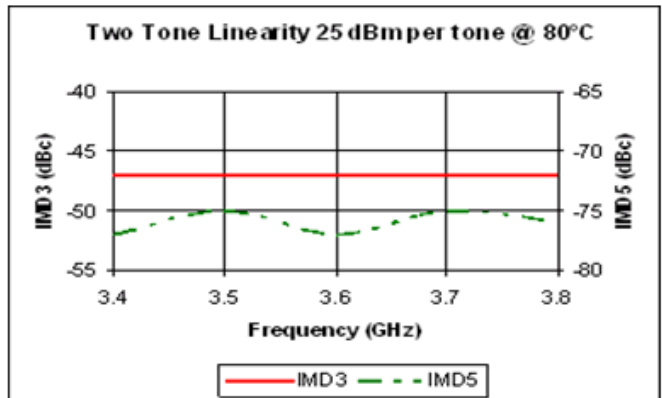

Figure 8 IMD 3 and IMD 5

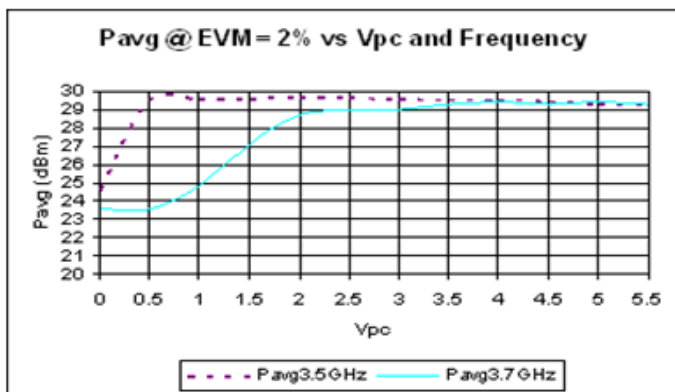

Figure 9 Pavg vs Vpc at EVM = 2%

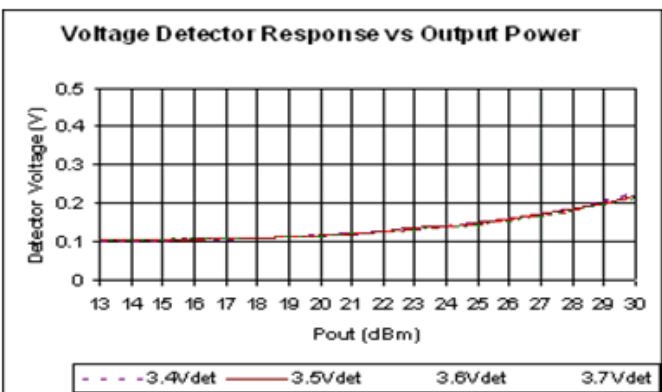
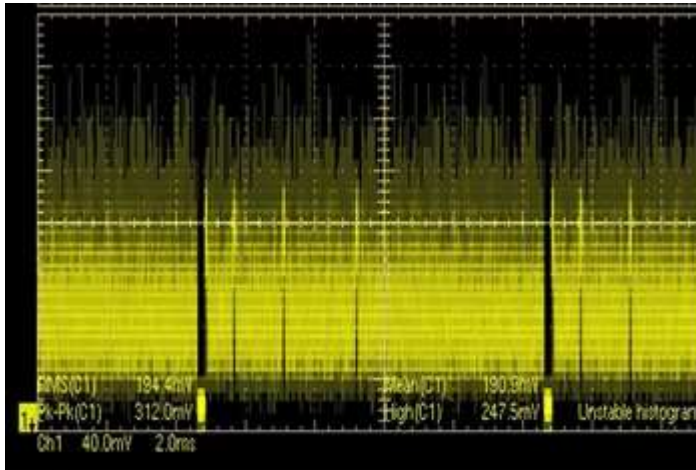

Figure 10 Detector Voltage Response

**Application Note (continued)**



**Figure 11 RF Envelope**

The RF detector response shown in Figure 10 uses a directional coupler to monitor the RF output. The TSS for this detector is 17 dBm and the top end of dynamic range is 36 dBm. The detector variation over frequency is less than 1.0 dB. The set on accuracy for TSS can vary from 0.1 to 0.7 volts. The DC variation over temperature from 0°C to 80°C is +/- 1.5 dB.

The RF envelope shown in Figure 11 is a WiMAX 802.16d signal with a continuous frame burst of 10 msec. The four data bursts, BPSK, QPSK, 16QAM and 64QAM are evident by the presence of their preambles. The RMS output is 194 mV. The average power is 29.2 dBm. Adding the appropriate time delay, the detector can be used to drive an envelope tracking circuit.

Applications that require a RF coupled port or information about envelope tracking should consult the factory.

Downlink Burst Summary List @ F=3.7 GHz					
Burst	Area	Modulation	Length(sym)	Power(dBm)	EVM(dB)
Burst 1	Preamble	BPSK	1	32.19	-40.5
	Data	BPSK	11	29.3	-33.8
Burst 2	Preamble	BPSK	1	32.19	-40.5
	Data	QPSK	20	29.3	-33.9
Burst 3	Preamble	BPSK	1	32.19	-40.5
	Data	16QAM	30	29.3	-33.9
Burst 4	Preamble	BPSK	1	32.19	-40.4
	Data	64QAM	79	29.3	-33.9
Overall			144	30	-34.3

**Figure 12 Burst Summary**

The burst summary shown in Figure 12 is measured at 3.7 GHz and represents the WiMAX test signal used for this application. The frame length is 144 symbols. BPSK is 11 symbols; QPSK is 20 symbols; 16QAM is 30 symbols and 64QAM is 79 symbols. The driver and SMU200A contribute about 1% of the total EVM measurement. Channel estimation is enabled during the EVM measurement.

One watt of average power is measured at 2% EVM at 3.7 GHz.

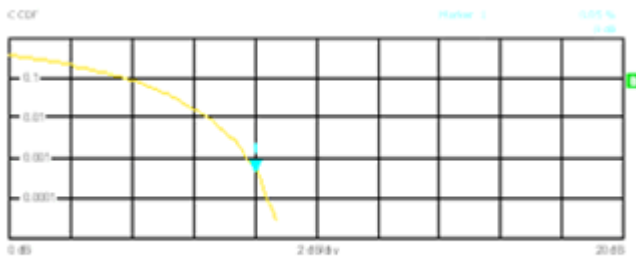

**Figure 13 CCDF**

The detector slope is 17 mV per dB at the high end of the dynamic range. The peak envelope excursions are 347 mV above the mean value or roughly 9 dB above the peak.

The CCDF shown in Figure 13 confirms that the peak is approximately 9 dB and that the crest factor is 8.3 dB.

## Application Note (continued)

At Vdd1=Vdd2=5.0 volts, the MMA-343737-Q10 has an output power of 24.5 dBm at EVM=2% shown in Figure 14. The WiMAX test signals were generated using the Rhode & Schwarz SMU200A modulator and the FSQ26 is used to analyze signal integrity.

IEEE 802.16-2004 OFDM			
Frequency:	3.7 GHz	Signal Level Setting:	5.9 dBm
Sweep Mode:	Continuous	External Att:	1.5 dB
Burst Type:	OFDM DL Burst	Trigger Mode:	External
		Trigger Offset:	-10 us
		Modulation:	ALL
		No. OF Data Symbols:	1/2425

Result Summary						
No. of Bursts	1					
	Min	Mean	Limit	Max	Limit	Unit
EVM All Carriers	2.08	2.13	2.82	2.22	2.82	%
EVM Data Carriers	2.08	2.14		2.22		%
EVM Pilot Carriers	1.95	2.03		2.21		%
IQ Offset	0.18	0.18	17.78	0.18	17.78	%
Gain Imbalance	0.05	0.05		0.05		%
Quadrature Error	0.002	0.002		0.002		°
Center Frequency Error	146.09	146.09	± 29600	146.09	± 29600	Hz
Clock Error	- 0.02	- 0.02	± 8	- 0.02	± 8	ppm
Burst Power	24.43	24.46		24.47		dBm
Crest Factor	8.18	8.77		9.34		dB
RSSI	9.36	9.36		9.36		dBm
RSSI Standard Deviation		- 11.30				dB
CINR	38.52	38.52		38.52		dB
CINR Standard Deviation		1.25				dB

**Figure 14 802.16, 256 carriers, 64 QAM at 3.7 GHz, EVM=2% @ Pavg=24.5 dBm**

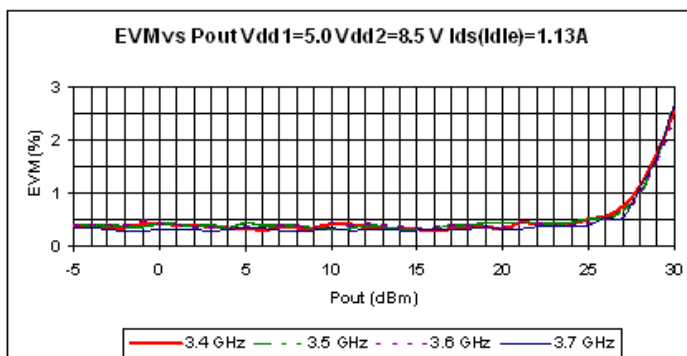

**Figure 15 EVM vs Pout**

The average power at EVM=2% is typically better than 29.0 dBm over the frequency range as shown in Figure 15.

The bias voltage Vdd1=5.0 and Vdd=8.5 volts. The idle current is 1.13A and increases to 1.3A at 2% EVM.

The source and driver contribute about 0.8% of the total EVM.

## Application Note (continued)

At Vdd1=Vdd2=6.0 volts, the MMA-343737-Q10 has an output power of 26 dBm at EVM=2% shown in Figure 16. The WiMAX test signals were generated using the Rhode & Schwarz SMU200A modulator and the FSQ26 is used to analyze signal integrity.

IEEE 802.16-2004 OFDM			
Frequency:	3.7 GHz	Signal Level Setting:	7.2 dBm
Sweep Mode:	Continuous	External Att:	18 dB
Burst Type:	OFDM DL Burst	Trigger Mode:	External
		Trigger Offset:	-10 $\mu$ s
		No Of Data Symbols:	1/2425

Result Summary						
No. of Bursts	1					
	Min	Mean	Limit	Max	Limit	Unit
EVM All Carriers	2.03	2.09	2.82	2.19	2.82	%
EVM Data Carriers	2.03	2.09		2.19		%
EVM Pilot Carriers	1.90	2.00		2.22		%
IQ Offset	0.19	0.19	17.78	0.19	17.78	%
Gain Imbalance	0.04	0.04		0.04		%
Quadrature Error	- 0.002	- 0.002		- 0.002		°
Center Frequency Error	145.56	145.56	± 29600	145.56	± 29600	Hz
Clock Error	- 0.02	- 0.02	± 8	- 0.02	± 8	ppm
Burst Power	25.92	25.94		25.96		dBm
Crest Factor	8.12	8.75		9.21		dB
RSSI	10.88	10.88		10.88		dBm
RSSI Standard Deviation		- 9.78				dB
CINR	39.12	39.12		39.12		dB
CINR Standard Deviation		- 2.43				dB

**Figure 16 Vdd=6.0 volts at Ids=1.2A at 3.7 GHz, EVM = 2.0% @ Pavg=26.0 dBm**

## Application Note (continued)

At Vdd1=Vdd2=8.5 volts, the MMA-343737-Q10 has an output power of 29.2 dBm at EVM=2% shown in Figure 17. The WiMAX test signals were generated using the Rhode & Schwarz SMU200A modulator and the FSQ26 is used to analyze signal integrity.

IEEE 802.16-2004 OFDM						
Frequency: 3.7 GHz	Signal Level Setting: 12.7 dBm	External Att: 18.2 dB				
Sweep Mode: Continuous	Trigger Mode: External	Trigger Offset: -10 us				
Burst Type: OFDM DL Burst	Modulation: ALL	No Of Data Symbols: 1/2425				

  

Result Summary						
No. of Bursts	4					
	Min	Mean	Limit	Max	Limit	Unit
EVM All Carriers	1.98	2.04	2.82	2.16	2.82	%
EVM Data Carriers	1.98	2.05		2.16		%
EVM Pilot Carriers	1.86	1.96		2.19		%
IQ Offset	0.19	0.19	17.78	0.19	17.78	%
Gain Imbalance	0.11	0.11		0.11		%
Quadrature Error	- 0.035	- 0.035		- 0.035		°
Center Frequency Error	152.04	152.04	± 29600	152.04	± 29600	Hz
Clock Error	0.00	0.00	± 8	0.00	± 8	ppm
Burst Power	29.22	29.25		29.26		dBm
Crest Factor	8.16	8.63		8.99		dB
RSSI	13.98	13.98		13.98		dBm
RSSI Standard Deviation		- 6.65				dB
CINR	40.07	40.07		40.07		dB
CINR Standard Deviation		1.23				dB

Figure 17 Vdd1=Vdd2=8.5 volts at Ids=1.3A at 3.7 GHz, EVM = 2.0% @ Pavg=29.2 dBm

## Application Note (continued)

### Typical response for 802.16 Pavg=29.5 dBm and 2.5% EVM

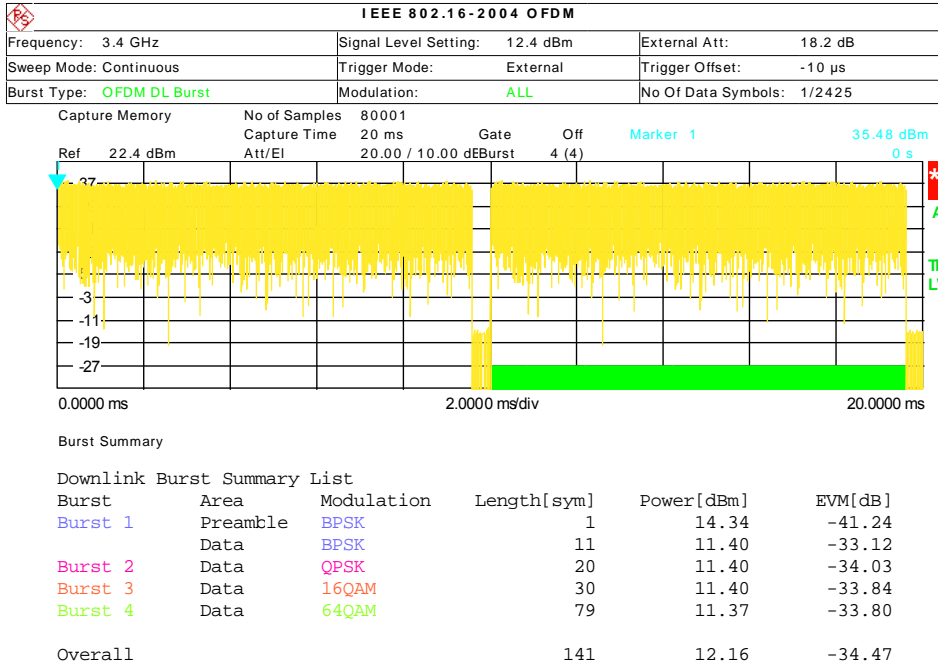

**Figure 18**  
 WiMax 802.16d Pavg=30.4 dBm at 3.4 GHz for 2.0% EVM for all carriers.

The test signal is 256 carriers, 64 QAM with 2/3 coding factor.

The signal power versus time is shown in yellow.

The burst summary shows the power and EVM values for each modulation.

The preambles have been disabled with the exception of the frame channel information.

Vdd2=8.5V and Ids=1.36A

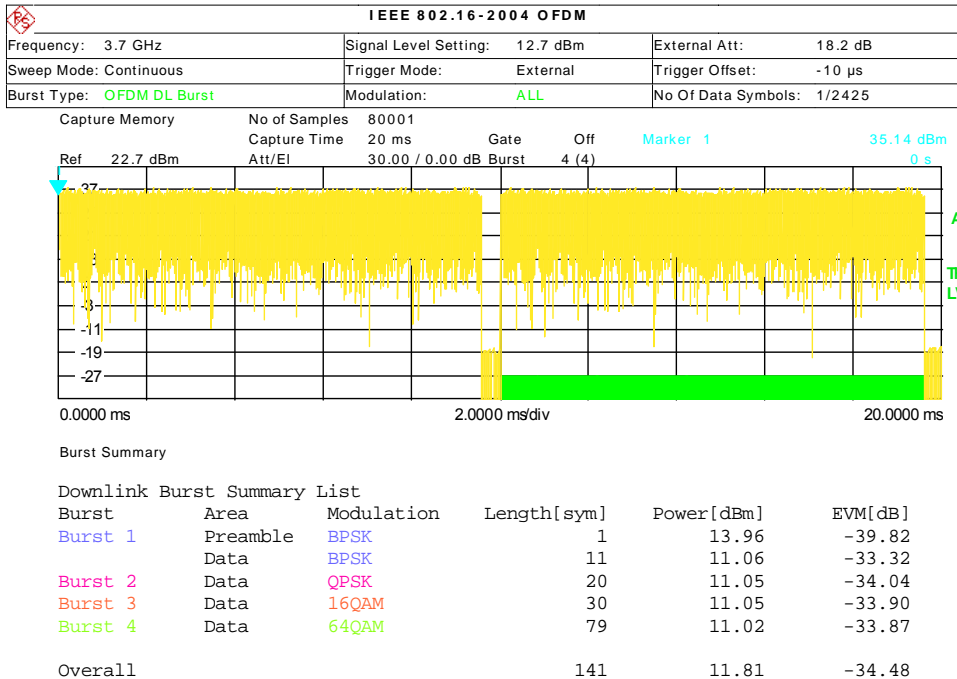

**Figure 19**  
 WiMax 802.16d Pavg= 30.0 dBm at 3.7 GHz for 2.0% EVM.

The preambles have been disabled with the exception of the frame channel information.

Vdd2=8.5V and Ids=1.35A