

## Features:

- 45 dBm IP3
- 12.5 dB Gain
- +28.5 dBm P1dB
- Single Positive Bias
- Leadless Surface Mount Package

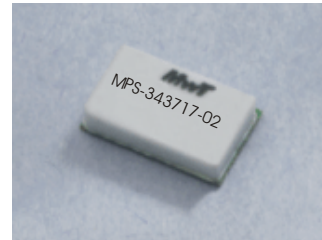

## Description:

The MPS-343717-02 is a low cost high linearity modular amplifier designed to meet the ultra-linear transmitter driver requirements for commercial 2G, 2.5G, 3G, GSM, TDMA, EDGE, UMTS, WCDMA, CDMA2000, and TD-SCDMA applications. Key advantages are low intermodulation performance for multi-carrier and CDMA systems and exceptionally low input/output return loss for ease of integration.

## Electrical Specifications:

- @ 25°C, Vdd = 6.0 to 7.0 V\*, Zo = 50 ohms

SYMBOL	PARAMETERS	Min	Typical	Max	Unit
Freq.	Frequency Range	3400		3700	MHz
SSG	Small Signal Gain	11.7	12.5		dB
P1 dB	Pout at 1 dB Comp Point		+28.5		dBm
IP3 (1)	Third-Order Intercept	42.0	45.0		dBm
VSWR	VSWR (Input/Output)		1.5:1/2.5:1		
GOF	Gain Var. over Frequency		± 0.3	± 0.6	dB
GOT	Gain Var. over Temp		-0.015		dB/°C
Idd	DC Current		380	450	mA
Rth	Thermal Resistance		28		°C/W

(1) Two tone test @ 13 dBm/tone, centered at 3,500 MHz with 20 MHz separation.

(2) Use Vds = 6V for calculation of DC dissipation.

\* Bias range for best operation.

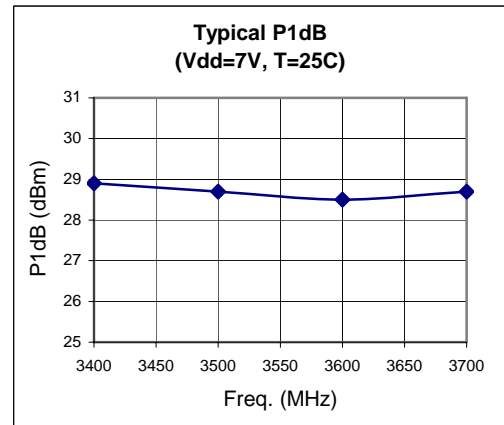

## Absolute Maximum Ratings:

Maximum Bias Voltage	8.0 V
Maximum continuous RF Input Power	950 mW
Maximum Peak Input Power	1400 mW
Maximum Case Operating Temperature	+ 85 °C
Maximum Storage Temperature	- 65 °C to + 150 °C

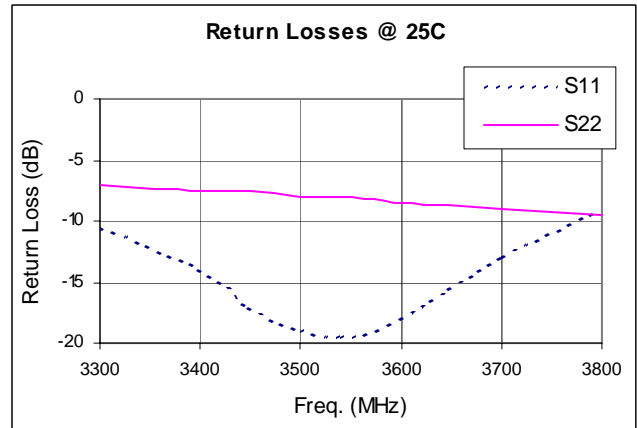
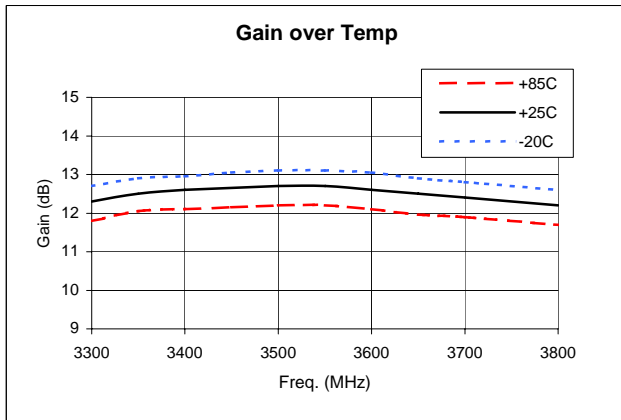
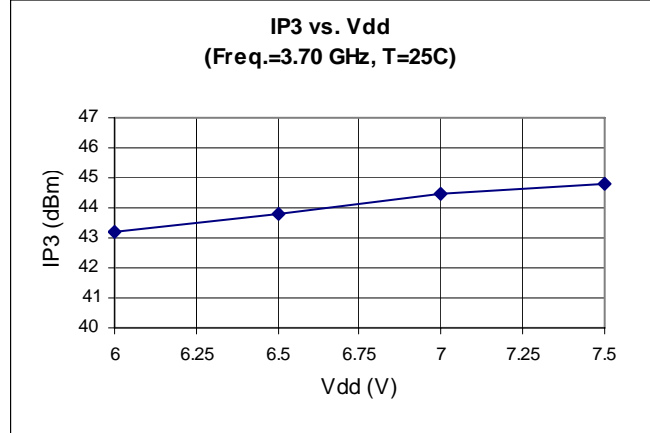
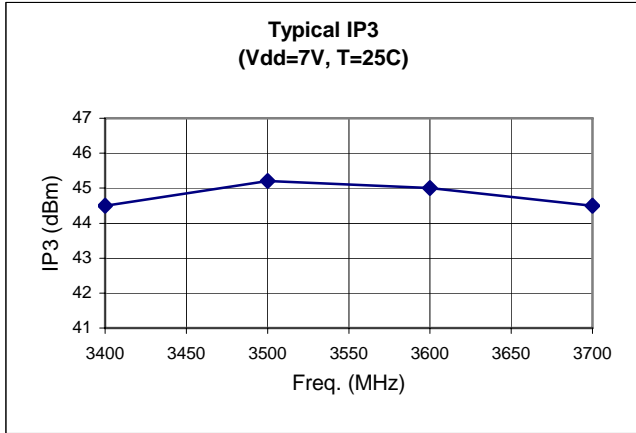

### Outline Diagram

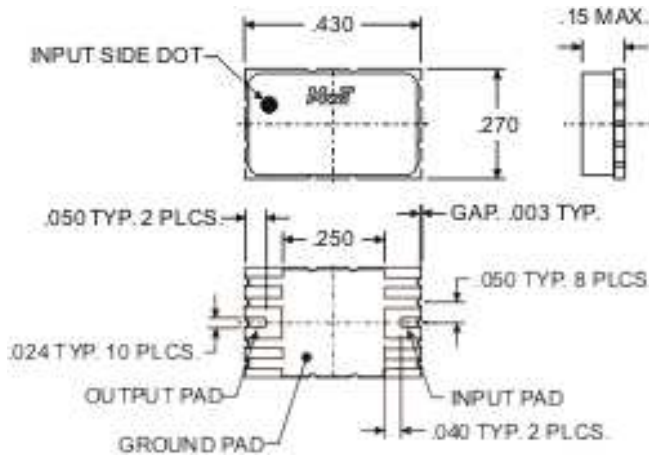

### Application Circuit

